

B E G L E C

HITMUSIC

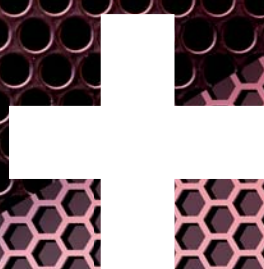

2018 EDITION

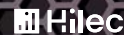



# EDITORIAL

The sum (+) of two companies is the right formula we have chosen for the coming years.

The BEGLEC HITMUSIC group combines its skills, talents, people, ranges, capacities and services to offer you more intense collaboration in the years to come.

This catalogue of the group, historic because it is the very first, illustrates perfectly the direction that we set ourselves and towards which we invite you to follow us. Together, only “+” in 2018!

**Pierre DENJEAN** – Partner BEGLEC NV – Chairman HIT MUSIC SAS

For several years we have been looking for a strategic partner to strengthen our company. With HIT MUSIC, we have found a partner who shares the same values and applies the same working methods. This is a very big step forward for both companies. It is with great energy and passion that we embark on this adventure. And dare we suggest that this is only the beginning of more things to come. The future will tell.

**Luc DE BAUW** – Partner BEGLEC NV – Director BEGLEC NV

With HIT MUSIC we have found a good partner for the future. An even greater challenge for the years to come. We can all do it together!

**Marc DE BAUW** – Partner BEGLEC NV

**ONLY**



**IN  
2018**

**4**

**BRANDS**  
BEGLEC

**2**

**BRANDS**  
HITMUSIC

**+**

**1**

**BRAND**  
ACCESSORIES

**=**

**7**

**exclusive**  
**BRANDS**



**BEGLEC**



**HITMUSIC**

**=**

**48**

**COUNTRIES**  
covered  
**IN 2017**

**10**

**TECHNICAL STAFF  
BEGLEC**



**7**

**TECHNICAL STAFF  
HITMUSIC**

**=**

**17**

**PEOPLE**

**for**

**TECHNICAL  
BACKUP &  
ENGINEERING**

**BEGLEC**

**31**

**YEARS**

**HITMUSIC**

**27**

**YEARS**



**58 YEARS**  
expertise &  
skills



**6000 M<sup>2</sup>**

BEGLEC  
IN BELGIUM

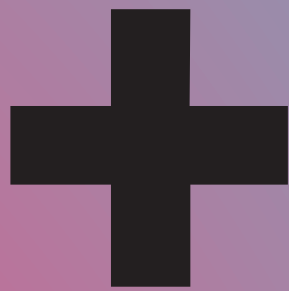

**4000 M<sup>2</sup>**

HITMUSIC  
IN FRANCE



**10 000 M<sup>2</sup>**

T O T A L  
S T O R A G E

**915**  
PRODUCTS  
BEGLEC



**1298**  
PRODUCTS  
HITMUSIC

**=**

**2213**  
PRODUCTS  
in this catalogue

## TECHNICAL DEPARTMENT

MARK AMERYCKX  
SYLVAIN TERROU

PIETER SEMPELS  
HUGO DE ROECK  
THOMAS ROMMELAERE

ERIC LAFAYE  
YOANN DELON

PATRICIA PANGRAZZI

# 17

MICHEL MOTTIER  
MARIO HEYLEN  
SABRY FREH  
THOMAS DEBOUCHE  
KOEN VAN DER AA  
JONATHAN GILLARD

RÉMY BEFFARA  
FABIEN DUPERRIN  
JACQUES DESMARIAUX

## IT & MARKETING DEPARTMENT

STEPHANE KOHN  
ARNAUD GARDERES

# 6

KRISTIN VANDIONANT  
THOMAS RIO  
MARIUS VANDEN CLOOSTER  
LOÏC GUILLIOUT

# 10

PHILIPPE BALLAND  
KEVIN BONNEFOY  
HERVÉ CAUVIN  
JACQUES LAVEYSSIERE

# = 57 SKILLED

# 3





# ASSOCIATES

LUC DE BAUW DIRECTEUR BEGLEC

PIERRE DENJEAN PRÉSIDENT HITMUSIC

MARC DE BAUW

# 14

## SALES DEPARTMENT

STEFAAN WINDEY  
JACKY MARTIN  
FILIP VERMANT

KEVIN VAN DER TAELEN  
OLIVIER PASTOR

YVES POLLET  
PETER VAN DEN ABBEELE

DANIEL NADIM  
DAVID SZYMANSKI  
DANIEL PICARD  
PHILIPPE PRENEAU  
LAURENT GAUDRY

CAROLE VINCENT  
HILDE VERSCHUERE

## LOGISTICS CENTER

PATRICE ESCUER  
STEVE GAORGIEVSKI  
OLIVIER PIETERS  
DIDIER VAN HOLME  
TOM CLEMENT  
GILLIAN JONVILLE

# 7

## ADMINISTRATION & FINANCE DEPARTMENT

FRANÇOISE FUSERO  
MARIE DO  
ISABELLE BABILLOTTE

JOCELYNE CALES  
INGE SCHELFHOUT  
FABIENNE RIVIERE  
SARAH LAGRING

# STAFF

# COMMERCIAL NETWORK

Find your commercial by sector

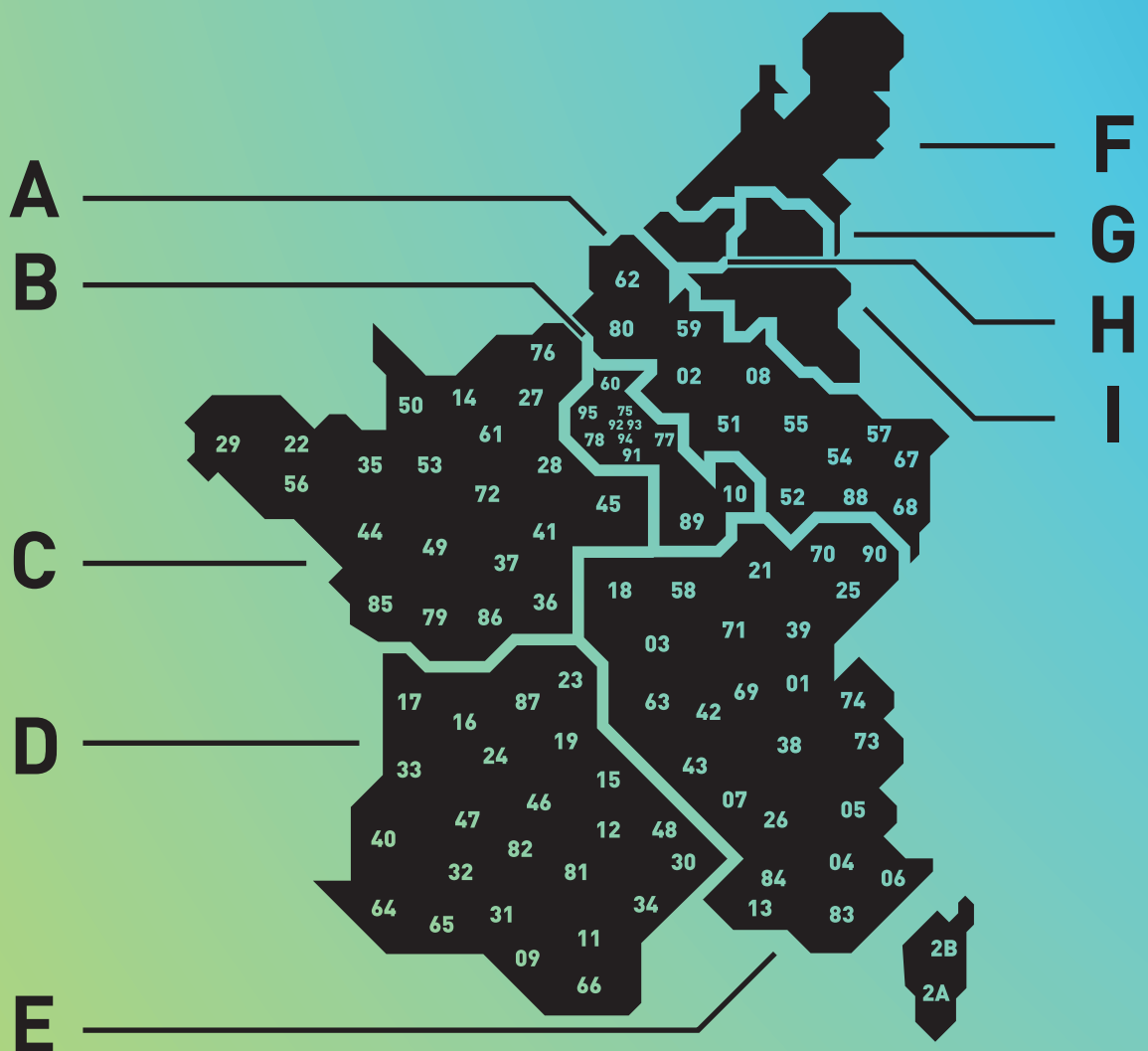

**A** NORTH-EAST FRANCE  
**David SZYMANSKI**

Tel. : +33 (0)6 74 53 93 51  
david.szymanski@hitmusic.eu

**B** PARIS  
PARIS AREA  
**Daniel NADIM**

Tel. : +33 (0)6 13 28 74 52  
daniel.nadim@hitmusic.eu

**C** NORTH-WEST FRANCE  
**Philippe PRENEAU**

Tel. : +33 (0)6 13 28 74 51  
philippe.preneau@hitmusic.eu

**D** SOUTH-WEST FRANCE  
**Laurent GAUDRY**

Tel. : +33 (0)6 13 28 74 54  
laurent.gaudry@hitmusic.eu

**E** SOUTH-EAST FRANCE  
**Daniel PICARD**

Tel. : +33 (0)6 13 28 74 53  
daniel.picard@hitmusic.eu

**F** THE NETHERLANDS

Tel. : +32 (0)2 481 70 70  
orders@beglec.com

**G** LIMBOURG / ANTWERP  
FLEMISH BRABANT  
**Filip VERMANT**

Tel. : +32 (0) 471 854 873  
vermant.filip@beglec.com

**H** EAST & WEST  
FLANDERS  
**Stefaan WINDEY**

Tel. : +32 (0) 472 325 224  
windey.stefaan@beglec.com

**I** WALLONIA / BRUSSELS  
LUXEMBURG  
**Jacky MARTIN**

Tel. : +32 (0) 473 505 779  
martin.jacky@beglec.com

 **EXPORT**

**Kevin VAN DER TAELEN**  
Tel. : +32 (0)2 481 70 70  
export@beglec.com

**Olivier PASTOR**  
Tel. : +33 (0)6 43 35 92 28  
olivier.pastor@hitmusic.eu

**HIT MUSIC SAS**  
Parc d'Activités Cahors Sud  
En Teste  
46230 FONTAINES  
France  
Tel. : +33 (0)5 65 21 50 00  
contact@hitmusic.eu

**OPENING HOURS**  
Monday → Friday  
9:00 to 12:00 & 13:15 to 17:15

**BEGLEC NV**  
't Hofveld 2c  
Industriezone "Gosset"  
B-1702 Groot-Bijgaarden  
Belgique  
Tel. : +32 (0)2 481 70 70  
orders@beglec.com

**OPENING HOURS**  
Monday → Friday  
8:30 to 12:15 & 13:00 to 17:00



# SUMMARY

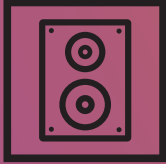

**P16**

SOUND



**P72**

PORTABLE SOUND

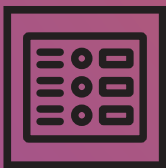

**P80**

COMMERCIAL AUDIO



**P100**

LIGHT INTEGRATION



**P126**

LIGHT



**P210**

EFFECT MACHINES



**P220**

FLIGHT-CASES



**P228**

TRUSS

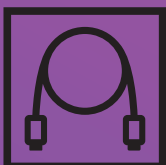

**P280**

ACCESSORIES

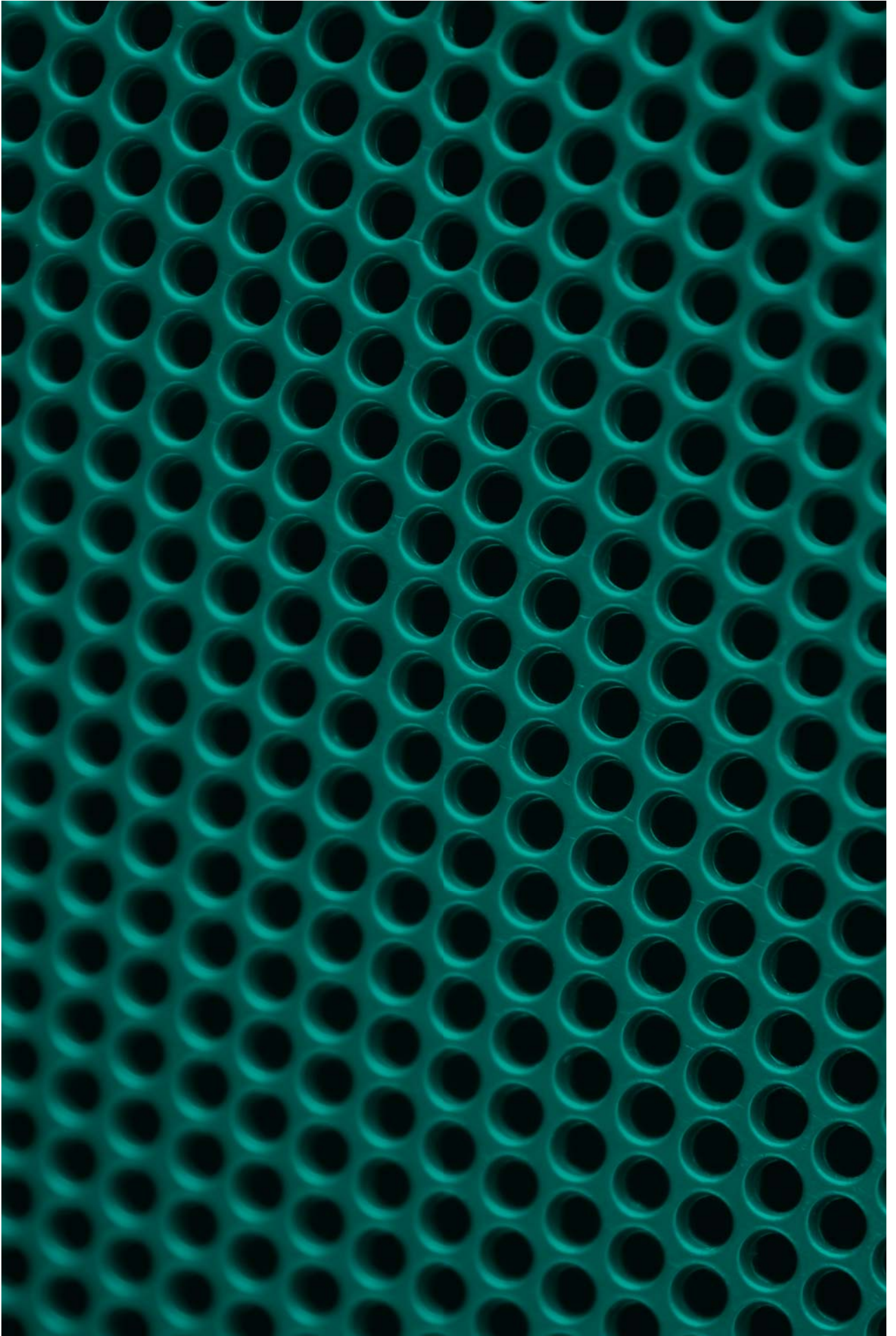



# SOUND

ACTIVE SYSTEMS  
ACTIVE SPEAKERS  
PASSIVE SPEAKERS  
SUBWOOFERS  
AMPLIFIERS  
SOUND PROCESSING  
MIXERS  
MIDI CONTROLLERS  
CD PLAYERS  
TURNTABLES  
WIRED MICROPHONES  
WIRELESS MICROPHONES  
HEADPHONES

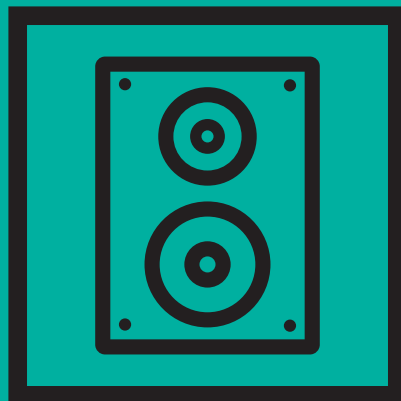

# ILINE COLUMN ARRAY

Complete iLINE COLUMN ARRAY set



## “Column Array” column systems

Aesthetically pleasing, the system comes with 2 families of columns. One for installation with columns iLINE23, iLINE43, iLINE83, and the other for stage performance with the iLiNE83B model.

They are linked and powered by an active subwoofer, the iLINEsub12A which embeds a double amplification of 700W/5 Ohms in class D for the columns and 700W/4 Ohms for the lower part because we can also add the iLINEsub12A as a reinforcement, which is the passive version of the subwoofer.

## Modulate your desires.

Whether for mobile or fixed use, the system answers all your problems.

The system offers multiple possible combinations, for example, 2 columns, 1 subwoofer or 2 subwoofers, 2 columns, etc.

Once controlled by an active subwoofer, the iLINEsub12P passive subwoofers can supply the satellites for numerous configurations.



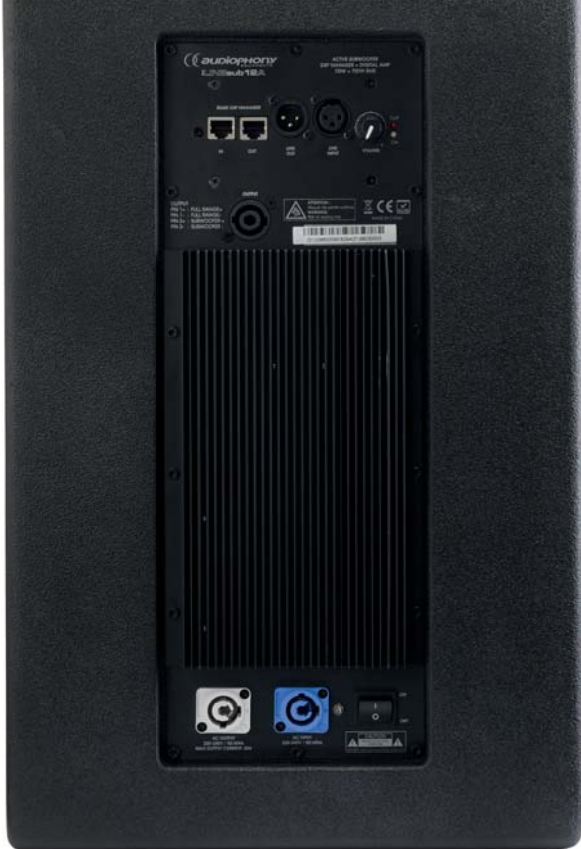

## A system that travels well.

Lightweight and robust, the subwoofers are made of a very resistant wood, Finnish birch multi-ply plywood with a protective polyurethane resin coating, which is very resistant to weather and scratches.

You can transport your entire iLINE system anywhere.

## Touch the power, that's all!

If you want to touch the system's sound settings, an "iLINEbox" USB to RJ45 converter is sold separately. This box is needed if you want to adjust the built-in DSP.

The native DSP is preset to factory settings in order to ensure optimal system behaviour.



Only compatible with Windows



# ILINE COLUMN ARRAY

Discover the different configurations available to purchase.



**iLINE**  
Stereo configuration 2.1 - 1020W

Code : H10879



- 2x iLINE83 (H10756)
- 2x iLINEsub12A (zH10761)
- 1x iLINEbox (H10762)
- 2x CAB-200 (H8245)
- 2x CSP215/6 (H9841)



**iLINE**  
Mono configuration 510W

Code : H10880



- 1x iLINE83B (H10758)
- 1x iLINEspace60 (H10759)
- 1x iLINEsub12A (H10761)
- 1x iLINEbox (H10762)



**iLINE**  
Stereo configuration 2040W

Code : H10881



- 4x iLINE83B (H10758)
- 2x iLINEsub12P (H10763)
- 2x iLINEsub12A (H10761)
- 2x iLINEcord60 (H10764)
- 1x iLINEbox (H10762)



**iLINE**  
Mono configuration 1020W

Code : H10882



- 2x iLINE83B (H10758)
- 1x iLINEspace60 (H10759)
- 1x iLINEbase (H10760)
- 1x iLINEsub12P (H10763)
- 1x iLINEsub12A (H10761)
- 1x iLINEcord60 (H10764)
- 1x iLINEbox (H10762)
- 1x CSP215/3 (H9840)

**The RJ45 cord that connects the iLINEbox to the iLINEsub12A is not supplied.**  
See the LINK-RJ cords in accessories section  
Available in multiple lengths







**iLINE**

2680W stereo installation combination

Code : H10883



- 8x iLINE83 (H10756)
- 8x iLINE83sup (H10757)
- 2x iLINEsub12P (H10763)
- 2x iLINEsub12A (H10761)
- 2x iLINEcord60 (H10764)
- 1x iLINEbox (H10762)
- 2x CSP215/3 (H9840)



**iLINE**

940W stereo installation combination

Code : H10884



- 4x iLINE43 (H10754)
- 4x iLINE24sup (H10773)
- 2x iLINEsub12A (H10761)
- 1x iLINEbox (H10762)



**iLINE**

510W mono installation combination

Code : H10885



- 4x iLINE23 (H10752)
- 4x iLINE23sup (H10753)
- 1x iLINEsub12A (H10761)
- 1x iLINEbox (H10762)



# ILINE COLUMN ARRAY



**iLINE83B**  
160W @ 16 Ohms column with 8 3-inch speakers - with stackable connector base

Code : H10758



**iLINE83**  
160W @ 16 Ohms column with 8 3-inch speakers for installation

Code : H10756



**iLINE83sup**  
Wall bracket for iLINE83 column

Code : H10757



**iLINE43**  
80W @ 8 Ohms column with 4 3-inch speakers for installation

Code : H10754



**iLINE43sup**  
Wall bracket for iLINE43 column

Code : H10755



**iLINE23**  
40W @ 16 Ohms column with 2 3-inch speakers for installation

Code : H10752



**iLINE23sup**  
Wall bracket for iLINE23 column

Code : H10753



**iLINE24sup**  
Adjustable wall bracket for iLINE23 and iLINE43

Code : H10773



	<b>iLINE23</b>	<b>iLINE43</b>	<b>iLINE83</b>	<b>iLINE83B</b>	<b>iLINEsub12A</b>	<b>iLINEsub12P</b>
Power	40W RMS / 80W Max	80W RMS / 160W Max	160W RMS / 320W Max	160W RMS / 320W Max	700+700 W RMS / 4Ω	400W RMS / 800W Max
Frequencies	135 Hz / 17 kHz	135 Hz / 17 kHz	135 Hz / 17 kHz	135 Hz / 17 kHz	50 Hz / 200 Hz	50 Hz / 200 Hz
Sensitivity	89 dB / 108 dB max	92 dB / 114 dB max	95 dB / 120 dB max	95 dB / 120 dB max	96 dB / 124 dB max	96 dB / 125 dB max
Impedance	16Ω	8Ω	16Ω	16Ω	8Ω	8Ω
Speakers	2x3"	4x3"	8x3"	8x3"	12"	12"
Dispersion HxV	115° / 20°	115° / 20°	115° / 20°	115° / 20°	-	-
Dimensions	110x180x148 mm	110x350x148 mm	110x690x148 mm	110x770x148 mm	350x515x490 mm	350x515x490 mm
Weight	2.2 Kg	4 Kg	7.6 Kg	7.6 Kg	23.5 Kg	22 Kg



**iLINEsub12P**  
12-inch passive subwoofer - 400W - 8 Ohms

Code : H10763



**iLINEsub12A**  
12-inch active subwoofer 700W + 700W with built-in DSP

Code : H10761



**iLINEspace60**  
Increase height by 60cm for iLINE83B with stackable connector base

Code : H10759



**iLINEbase**  
Floor bracket for iLINE83B and iLINESPACE60

Code : H10760



**iLINEcord60**  
Speakon cord/Speakon 60cm for iLINE series

Code : H10764



**iLINEbox**  
USB → RJ45 converter for DSP of iLINEsub12A

Code : H10762



**iLINEbag**  
Carrying bag for 2 iLINE 8 HP columns or 2 iLINEspace 60

Code : H10767



**iLINEcov**  
Protective cover for iLINE series subwoofers

Code : H10768



More information on  
[www.iline-series.audiophony.com](http://www.iline-series.audiophony.com)

# MINI LINE ARRAY HELIUM

## LINE-ARRAY HELIUM SERIES

A la carte system with choice of active subwoofer and passive heads.

The set can operate in mini line array and also in 2.1 on stands thanks to the optional accessories.

The Helium system is designed to meet the needs of installers who want to benefit from line array technology while maintaining ease of use and minimum space requirements.

The quality of the mid-high grain associated with the system's directivity creates a clear and precise diffusion.



### HL-10ASUB

Subwoofer for active compact line array  
2 x 10 inches - 400W RMS

Code : H10520



### HL-8ASUB

Subwoofer for active compact line array  
2 x 8 inches - 300W RMS

Code : H10519



### HL-4

Head for passive compact line array

Code : H10518



### HL-BUMPER

Suspension frame for hanging the complete line array

Code : H10521



### HL-FRAME

Support for hanging the HL-4 heads

Code : H10522



### HL-POLE

Base for HL-FRAME

Code : H10523



	HL-4	HL-8ASUB	HL-10ASUB
Power	100W RMS - 200W max	300W RMS - 600W max	Power rating: 400W RMS - 800W max
Frequency response	150 Hz - 25 KHz	80 - 200Hz	Frequency response: 50 - 200Hz
SPL max (to 1 m)	121 dB	110 dB	SPL max. (@1m) : 114 dB
Nominal impedance	16 Ω	4 Ω	Nominal impedance: 4 Ω
Woofer	2x4"	2 x 8 inches	Woofer: 2 x 10 inches
Tweeter	1x ribbon tweeter	-	
Dispersion	Pavilion waveguides (HxV) 120° x 30° to 90° depending on the cluster angle	-	
Connectors	IN/OUT speakon	-	
Dimensions	485x135x260 mm	485 x 540 x 260 mm	485 x 540 x 310 mm
Net weight	5.2 kg	19.2 kg	29.2 kg

### Amplification

Low level	-	2x 200W RMS / Class D - 8 Ω	2x 320W RMS / Class D - 4 Ω
Mid/high level	-	2x 200W RMS / class D - 8 Ω Set has a maximum of 800W	2x 200W RMS / class D - 8 Ω Set has a maximum of 1040W
Inputs	-	2x Combo XLR/Jack line level	2x Combo XLR/Jack line level
Outputs	-	2x Combo XLR/Jack line level 2x Speakon amplified for heads	2x Combo XLR/Jack line level 2x Speakon amplified for heads
Adjustments		Volume: Adjustment of the system's general level Bass: Adjustment of subwoofer level STEREO/PARALLEL selector for use in 2.1 or in Line array	

# MINI LINE ARRAY CUB



**"MODULARITY" IS THE KEY WORD FOR QUALIFYING THIS SYSTEM.**

Whether for fixed installation or mobile use, this new concept is very attractive.

The CUBsat4 speaker can of course be used alone in a classic multi-source installation but not only here, thanks to its ingenious integrated coupling and angulation system, you can make up your system very simply and thus obtain Line Array columns for up to eight speakers.



### CUBsat4

Head of 30W RMS mini line array

Code : H10663



### CUBsub112

12-inch passive 300W subwoofer

Code : H10664



### CUBsub208

300W RMS 8-inch 2 HP passive subwoofer

Code : H10665



### CUB-Wall1

Wall bracket for CUBsat4

Code : H10730



### CUB-Pole1

Foot support for CUBsat4

Code : H10731



### CUB-Truss1

Suspension support for CUBsat4

Code : H10732



	CUBsat4	CUBsub112	CUBsub208
Power	30W RMS - 90W max	300W RMS - 600W max	Power rating: 300W RMS - 600W max
Frequency response	100Hz -20KHz	45Hz -2.8KHz	Frequency response: 50Hz -800Hz
Filter	2 passive channels at 3kHz	The subwoofer is not equipped with a passive filter	Filter: the subwoofer is not equipped with a passive filter
SPL max. (@1m)	91 dB	125 dB	SPL max. (@1m) : 124 dB
Nominal impedance	8 Ω for a module with integrated impedance adapter.	8 Ω	Nominal impedance: 4 Ω
Woofer	4" to neodymium	12" to 64 mm coil	Woofer: 2 x 8" to 50 mm coil
Tweeter	3 x 0.5" soft dome	-	-
Dispersion	Pavilion waveguides (HxV) 110° x 20° for a module	-	-
Cluster orientation	0°/4°/8°/12°	-	-
Connectors	for 3x 6.35 input jack and parallel and series link	Connectors: for 2x speakon and terminal block for In/Out	
Construction	cast aluminium body and mounting bracket, pin and steel hinge. Black finish	Multi-ply subwoofer and metal grating Well for coupling bar on the top and rubber feet underneath Black finish	Well for coupling bar on the top and rubber feet underneath and wall mounting plates on the side. Black finish
Dimensions	170 x 140 x 150 mm	350 x 500 x 540 mm	250 x 510 x 540 mm
Net weight	1.450 kg	20 kg	18.5 kg



# THE MOJO RANGE

All in one active systems with mixer and Bluetooth® input



## MOJO500LINE

Active system subwoofer and column + mixer with 1 Bluetooth® input

Code : H10529



## COV-MOJO500LINE

Protective cover for MOJO500LINE

Code : H10867



Power rating: 200W for the column + 300W for subwoofer
Frequency response: 50Hz -22KHz
SPL max. (@1m) : 116 dB
Woofer: 6 x 2.75" for the column + 1x8" for the subwoofer
Dispersion : 120° x 20° (HxV)
Connectors: 2x Combo Mic/Line + 1x RCA Line et 1x 3.5 Jack Line
Bluetooth® receiver on channel 3
Adjustments: Volume by channel + general Treble/Bass
Dimensions : (80 x 80 x 830 mm) x2 for the column and support 340 x 430 x 400 mm for the subwoofer
Net weight: 3.65 kg + 10.8 kg



The set weighs less than 20 kg and takes up very little space in a car boot.

Power rating: 320W for the satellites + 700W for the subwoofer
Frequency response: 50Hz -22KHz
SPL max. (@1m) : 120 dB
Woofer: 4.75" for the satellite + 1x10" for the subwoofer
Tweeter: 1" compression
Dispersion: 90° x 45° (HxV)
Connectors: 1x Mic/Line Combo + 1x Guitar/microphone jack + 2x line Jack and 1x 3.5 Auxiliary Line Jack
Bluetooth® receiver on channel 3
Adjustments: Volume and effect by channel + general Treble/Bass + subwoofer volume
Multi-effects DSP Reverb Plate/ Plate2/Room/Room2/Hall/Hall2, Delay, Vocal doubler
Dimensions : (225 x 140 x 110 mm) x2 for the satellites 345 x 450 x 400 mm for the subwoofer
Net weight: 3.8 kg + 14.5 kg



## MOJO1000FX

Active Subwoofer and satellites system + multi-effects DSP and a Bluetooth® input

Code : H10528



## COV-MOJO1000FX

Travel bag + trolley for MOJO1000FX

Code : H10350



# CPX SYSTEM

500W compact active audio system for all types of applications.



## CPX-1510 FULL SET

500W compact active audio system

Code : B00613



Power: 200W for satellites column + 300W for subwoofer

Frequency response: 35Hz -20KHz

SPL max. (@1m): 128 dB

Woofer: 10" for the satellite + 15" for the subwoofer

Tweeter: 1" compression

Dispersion: 90° x 70° (HxV)

Connectors: 2x XLR/line Jack input + 2x Speakon output

Adjustments: Satellite volume + subwoofer volume

Dimensions : (435x 305 x 440 mm) x2 for the satellites  
440 x 600 x 590 mm for the subwoofer

Net weight: 19.5 kg + 42.8 kg

## CPX-1510SAT (pair)

Two 10" satellite speakers

Code : B00611



Power: 200W

Frequency response: 100Hz -20KHz

SPL max. (@1m): 120 dB

Woofer: 10"

Tweeter: 1" compression

Dispersion: 90° x 70° (HxV)

Connectors: 2x Speakon

Dimensions: 435x 305 x 440 mm x2

Net weight: 19.5 kg



# ATOM ACTIVE SPEAKERS



The ATOM series is equipped with a simple DSP and is easy to use. It allows you to adjust and configure your speaker to the required use with the touch of a button. The internal processor's different presets adapt your speaker to the current use (front, backstage, etc.) but also the current sound application (DJ, Live, Speech, etc.) without forgetting the ability to correct bass and treble +/- 10dB in order to compensate for a room's acoustic problems, for example.

Each ATOM speaker offers two inputs and one output, a large choice of connectivity in order to connect all kinds of sources at Micro or Line level.



The design of this new series provides usage flexibility and exceptional installation thanks to M10 attachment points, backstage position and an ingenious 35mm double position base allowing the speaker to be used on a stand in a straight or inclined position of 7.5° downwards.





**NEW**



**ATOM15A**  
15-inch active speaker with DSP

---

Code : H10781

---



**NEW**



**ATOM12A**  
12-inch active speaker with DSP

---

Code : H10780

---



**NEW**



**ATOM10A**  
10-inch active speaker with DSP

---

Code : H10779

---



**NEW**



**COV-ATOM15A**  
Protective cover for ATOM15A

---

Code : H10786

---



**NEW**



**COV-ATOM12A**  
Protective cover for ATOM12A

---

Code : H10785

---



**NEW**



**COV-ATOM10A**  
Protective cover for ATOM10A

---

Code : H10784

---



	<b>ATOM15A</b>	<b>ATOM12A</b>	<b>ATOM10A</b>
CODE	H10781	H10780	H10779
Total power	400 W RMS - 1600 W DYNAMIC	400 W RMS - 1600 W DYNAMIC	300 W RMS - 1200 W DYNAMIC
Amplification class	D + AB	D + AB	D + AB
Power supply	SMPS switched-mode	SMPS switched-mode	SMPS switched-mode
Protection	Limiter, thermal and short-circuit	Limiter, thermal and short-circuit	Limiter, thermal and short-circuit
Frequency response	45 Hz to 20 kHz	50 Hz to 20 KHz	60 Hz to 20 kHz
Dispersion H x V	90° x 60°	90° x 60°	90° x 60°
SPL pressure	124 dB max	123 dB max	121 dB max
Woofers	15" of 3" coil	12" of 3" coil	10" of 2.5" coil
Tweeter	1.35"	1.35"	1"
Pre-amplification	1 MIC/LINE input on XLR/Jack Combo 1 LINE Input on RCA and 3.5 Jack	1 MIC/LINE input on XLR/Jack Combo 1 LINE Input on RCA and 3.5 Jack	1 MIC/LINE input on XLR/Jack Combo 1 LINE Input on RCA and 3.5 Jack
	Line output on XLR		
	Volume adjustment per channel		
DSP	Equalisation presets: Normal, Live, Club and Speech Position presets: feet, feedback, wall Treble and bass graphic equaliser		
Dimensions (H x W x D)	730 x 425 x 415 mm	628 x 365 x 355 mm	531 x 310 x 300 mm
Net weight	20.6 kg	17.3 kg	11.3 kg



# SR ACTIVE SPEAKERS

The SR series speakers have been designed for multi-purpose and intensive use. The four Presets offer effective protection and settings for all kinds of uses whether at the front, backstage, DJ set or Live.



## SR15A

Amplified 2-channel speaker - Bass reflex  
400 Watts RMS

Code : H10159



## SR12A

Amplified 2-channel speaker - Bass reflex  
400 Watts RMS

Code : H10158



## SR10A

Amplified 2-channel speaker - Bass reflex  
300 Watts RMS

Code : H10157



## COV-SR15

Cover for SR15A speaker

Code : H10169



## COV-SR12

Cover for SR12A speaker

Code : H10168



## COV-SR10

Cover for SR10A speaker

Code : H10167



	SR15A	SR12A	SR10A
CODE	H10159	H10158	H10157
Total power	400 W RMS - 800 W MAX	400 W RMS - 800 W MAX	300 W RMS - 600 W MAX
Amplification class	D + AB		
Power supply	SMPS switched-mode		
Protection	Limiter, thermal and short-circuit		
Frequency response	40 Hz to 20 kHz	45 Hz to 20 KHz	55 Hz to 20 kHz
Dispersion H x V	90° x 60°	90° x 60°	90° x 60°
SPL pressure	124 dB max	123 dB max	121 dB max
Woofer	15" of 3" coil	12" of 3" coil	10" of 2.5" coil
Tweeter	1.35"	1.35"	1"
Pre-amplification	1 MIC/LINE input on XLR/Jack Combo Line output on XLR General volume adjustment Flat, Live, DJ and Vocal equalisation presets		
Dimensions (H x W x D)	410 x 450 x 710 mm	360 x 400 x 630 mm	310 x 335 x 530 mm
Net weight	21.1 kg	19.2 kg	13.4 kg

# SX ACTIVE SPEAKERS



SX speakers are professional and multi-purpose. The choice of components combined with bi-amplification brings a rich and precise sound. The input connector is linked with an optional Bluetooth module that allows easy use with a smartphone or tablet.



**NEW**



**SX15A**  
300W 15-inch 2-channel active speaker

Code : H10778



**NEW**



**SX12A**  
300W 12-inch 2-channel active speaker

Code : H10777



**NEW** Bluetooth



**SX-BT**  
Bluetooth module for SX speaker

Code : H10886



**NEW**



**COV-SX15A**  
Protective cover for SX15A

Code : H10855



**NEW**



**COV-SX12A**  
Protective cover for SX12A

Code : H10854



	SX15A	SX12A
CODE	H10778	H10777
Total power	300 W RMS - 600 W MAX	300 W RMS - 600 W MAX
Amplification class	D	D
Power supply	SMPS switched-mode	SMPS switched-mode
Protection	Limiter, thermal and short-circuit	Limiter, thermal and short-circuit
Frequency response	50 Hz to 20 kHz	55 Hz to 20 kHz
Dispersion H x V	90° x 60°	90° x 60°
SPL pressure	121 dB max	120 dB max
Woofers	15" of 2" coil	12" of 2" coil
Tweeter	1.35"	
Pre-amplification	1 MIC/LINE Input on Combo and RCA Line output on XLR General volume adjustment "Contour" Preset	
Optional module	Bluetooth® receiver 4.0 Pairing, Play/Pause, Skip, Vol buttons	
Dimensions (H x W x D)	630 x 390 x 370 mm	600 x 380 x 340 mm
Net weight	14.5 kg	13.2 kg



# PSA ACTIVE SPEAKERS



- Bi-Amping technology with separate amplifiers
- Active two-channel filter
- 2 balanced MIC inputs + 1 LINE input with level adjustment
- Balanced LINE output
- Adjustment buttons for treble + bass + main volume



**PSA-15**  
15" active professional speaker

Code : B00617



**PSA-12**  
12" active professional speaker

Code : B00616



**PSA-10**  
10" active professional speaker

Code : B00629



**PSA-08**  
8" active professional speaker

Code : B00628



**TOURING BAG - PS-15/PSA-15**  
Cover for PS-15/PSA-15

Code : B00597



**TOURING BAG - PS-12/PSA-12**  
Cover for PS-12, PSA-12, PPA-121

Code : B00596



	PSA-15	PSA-12	PSA-10	PSA-08
Code	B00617	B00616	B00629	B00628
Total RMS power	245+55 W	165+35 W	130+30 W	120 W
Frequency response	40 Hz to 20 kHz	45 Hz to 20 KHz	60 Hz to 20 KHz	70 Hz to 20 KHz
Dispersion H x V	90° x 60°	90° x 60°	90° x 60°	90° x 60°
Woofer	15"	12"	10 inch	08 inch
Tweeter	1.75"	1.35"	1.35 inch	1 inch
Pre-amplification	1 MIC Input on XLR and RCA 1 LINE Input on RCA and XLR Line Output on XLR and JACK General volume and Mic and Line volume adjustment General Treble and Bass adjustment			
Dimensions (H x W x D)	680 x 470 x 400 mm	588 x 431 x 310 mm	500 x 355 x 270 mm	402 x 294 x 220 mm
Net weight	23.3 kg	17 kg	11.6 kg	8 kg

# MONITORS



**ACUTE08/AMP**  
150W active 8" moulded speaker

Code : H8738



**SUP-AC08N0**  
ACUTE08 monitor hanging bracket - black

Code : H8738



	ACUTE08/AMP
CODE	H8738
Total power	150 W RMS - 300 W MAX
Amplification class	D
Power supply	Toroidal
Protection	Limiter, thermal and short-circuit
Frequency response	70 Hz to 18 kHz
Dispersion H x V	90° x 60°
SPL pressure	117 dB max
Woofers	8" of 2" coil
Tweeter	1"
Pre-amplification	1 MIC Input on Jack 1 Input LINE on XLR Line output on XLR Mic and Line volume adjustment
Dimensions (H x W x D)	435 x 255 x 245 mm
Net weight	9.5 kg



**AM50**  
Set of active 5" studio monitors, equipped with a 2 x 35 W RMS amp

Code : B00623



	AM50
CODE	B00623
Total power	2x35 W RMS
Frequency response	65 Hz to 20 kHz
Woofers	5" Kevlar
Tweeter	3/4" soft dome
Pre-amplification	1 LINE Input on 3.5 Jack
	Line Output on RCA Amplified left output on terminal block
	General volume adjustment
Dimensions (H x W x D)	180 x 258 x 209 mm
Net weight	6.3 kg

# SC PASSIVE SPEAKERS

- Passive speakers for “high-end” performance
- Designed, developed and manufactured in Europe
- European components assembled in Hi-end coaxial speakers
- High quality Baltic birch plywood and polyurethane with coating of “Chemline” (USA) anti-scratch paint
- Very powerful and excellent performance



**SC-15**  
15" 2-channel 400 WRMS speaker

---

Code : B09183

---



**SC-12**  
12" 2-channel 400 WRMS speaker

---

Code : B09182

---



**SC-08**  
8" 2-channel 300 WRMS speaker

---

Code : B09181

---



**SC-05**  
5" 2-channel 250 WRMS speaker

---

Code : B09180

---



SC-15	SC-12	SC-08	SC-05
2-channel passive filter	2-channel passive filter	2-channel passive filter	2-channel passive filter
15" low frequency speaker with ferrite + 1.45" tweeter (1" coil)	12" low frequency speaker with ferrite + 1.45" tweeter (1" coil)	8" low frequency speaker with ferrite + 1.45" tweeter (1" coil)	5" low frequency speaker with ferrite + 1.75" tweeter (0.75" coil)
3 Speakons	3 Speakons	Speakon in/out 4-pin	Speakon in/out 4-pin + Euroblock 4-pin connector
Switch selection + -1 or + -2	Switch selection + -1 or + -2	Switch selection + -1 or + -2	Switch selection + -1 or + -2
Enclosure in multi-ply Finnish birch	Enclosure in multi-ply Finnish birch	Enclosure in multi-ply Finnish birch	OMEGA® fastening hook
Resistant textured black paint	Resistant textured black paint	Resistant textured black paint	Can be attached to a microphone stand using the U-bracket
Max SPL: 128dB	Max SPL: 128dB	Max SPL: 123dB	Max SPL: 119dB
Bandwidth: 54-19.000Hz (-3dB)	Bandwidth: 60-20.000Hz (-3dB)	Bandwidth: 70-20.000Hz (-3dB)	Bandwidth: 120-21.000Hz (-3dB)
Polarity: 60° x 40°	Polarity: 60° x 40°	Polarity: 90° cone	Polarity: 70° cone
Power rating: 400 W AES (recommend amplifier: 800W RMS)	Power rating: 400 W AES (recommend amplifier: 800W RMS)	Power rating: 300 W AES (recommend amplifier: 600W RMS)	Power rating: 250 W AES (recommend amplifier: 500W RMS)
Impedance: 8 Ω	Impedance: 8 Ω	Impedance: 8 Ω	Impedance: 16 Ω
Dimension : 368x580x447 mm	Size: 351x540x410 mm	Dimensions: 254x420x250 mm	Size: 165x165x165 mm
Weight: 19 kg	Weight: 16 kg	Weight: 8 kg	Weight: 4 kg

Accessories for attachments and flight cases available, see accessories section

# VIBE PASSIVE SPEAKERS



- Ideal for fixed installations in bars, clubs
- Very solid MDF enclosure
- Covered with metal grid and with acoustic foam inside
- Fibreglass pavilion

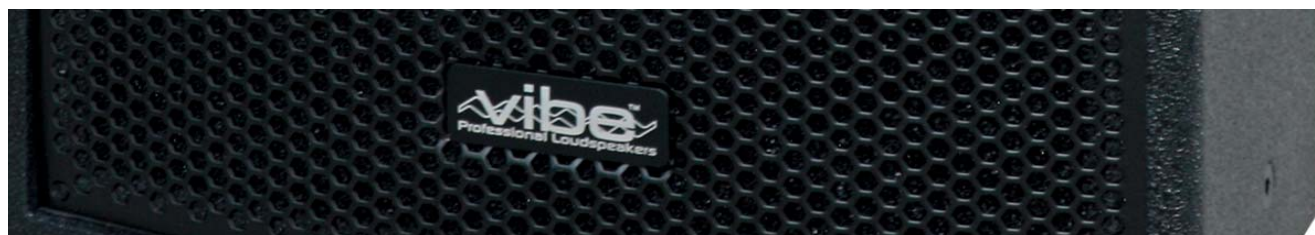

**VIBE30 MK2**  
Pro. speaker : 2x 15" - 800Wrms / 4 Ω

Code : B00693



**VIBE15 MK2**  
Pro. speaker : 15" - 350Wrms / 8 Ω

Code : B00692



**VIBE12MK2**  
Pro. speaker : 12" - 250Wrms / 8 Ω

Code : B00691



**VIBE10MK2**  
Pro. speaker : 8" - 150Wrms / 8 Ω

Code : B00689



**VIBE8 MK2**  
Pro. speaker : 2x 15" - 800Wrms / 4 Ω

Code : B00689



**CLS-8 II**  
8" compact high power speaker

Code : B00630



**TOURING BAG**  
Travel bag for Vibe 30

Code : B00593

**TOURING BAG**  
Travel bag for Vibe 15

Code : B00592

**TOURING BAG**  
Travel bag for Vibe 12

Code : B00591



VIBE30 MK2	VIBE15 MK2	VIBE12 MK2	VIBE10 MK2	VIBE8 MK2	CLS-8 II
Power rating: 800WRMS	Power rating: 350WRMS	Power rating: 250WRMS	Power rating: 200WRMS	Power rating: 150WRMS	Power rating: 200 WRMS
Impedance: 4 Ω	Impedance: 8 Ω	Impedance: 8 Ω	Impedance: 8 Ω	Impedance: 8 Ω	Impedance: 8 Ω
Max performance [dB] : 131	Max performance [dB] : 125	Max performance [dB] : 122	Max performance [dB] : 120	Max performance [dB] : 120	-
Bandwidth (Hz) : 40-20000	Bandwidth (Hz) : 45-20000	Bandwidth (Hz) : 55-20000	Bandwidth (Hz) : 65-20000	Bandwidth (Hz) : 65-20000	Bandwidth (Hz) : 70-20,000
Dimensions (cm) : 116 x 49 x 50.3	Dimensions (cm) : 76 x 47 x 43.5	Dimensions (cm) : 62 x 38.2 x 34.5	Dimensions (cm) : 33 x 51 x 30.2	Dimensions (cm) : 46.5 x 27.7 x 27	Dimensions (cm) : 46.0 x 28.6 x 27.6
Weight (kg) : 50	Weight (kg) : 29	Weight (kg) : 20	Weight (kg) : 15	Weight (kg) : 12	Weight (kg) : 13



# SR & ACUTE PASSIVE SPEAKERS



**SR15P**  
15" 300W plastic moulded passive speaker  
- GOA series

---

Code : H10270

---





**SR12P**  
12" 300W plastic moulded passive speaker  
- GOA series

---

Code : H10269

---





**SR10P**  
10" 200W plastic moulded passive speaker  
- GOA series

---

Code : H10268

---



**ACUTE-08NO**  
8" passive plastic speaker

---

Code : H9595

---



**ACUTE-08WH**  
8" passive plastic speaker white

---

Code : H9596

---



**SUP-AC08NO**  
ACUTE08 monitor hanging bracket - black

---

Code : H9598

---



**SUP-AC08WH**  
ACUTE08 monitor hanging bracket - white

---

Code : H9599

---



SR15P	SR12P	SR10P	ACUTE-08
Output power: 350W RMS / 700W max.	Output power: 350W RMS / 700W max.	Output power: 250W RMS / 500W max.	Output power: 150 W RMS
Frequency response: 45 Hz - 20 KHz	Frequency response: 55 Hz - 20 KHz	Frequency response: 65 Hz - 20 KHz	Frequency response: 70 Hz - 18 KHz
Impedance: 8 Ω	Impedance: 8 Ω	Impedance: 8 Ω	Impedance: 8 Ω
SPL: 96 dB max.	SPL: 96 dB max.	SPL: 94 dB max.	SPL: 94 dB max.
Dimensions: 410 x 450 x 710 mm	Dimensions: 360 x 400 x 630 mm	Dimensions: 310 x 335 x 530 mm	Dimensions: 435 x 255 x 245 mm
Net weight: 19.2 Kg	Net weight: 17.8 Kg	Net weight: 11.8 Kg	Net weight: 8 kg

# PS PASSIVE SPEAKERS



**PS-15**  
15" passive 300Wrms/8Ω speaker

---

Code : B00610

---



**PS-12**  
12" passive 200Wrms/8Ω speaker

---

Code : B00609

---





**PS-10**  
10" passive 160Wrms/8Ω speaker

---

Code : B00627

---





**PS-08**  
8" passive 120Wrms/8Ω speaker

---

Code : B00626

---



**TOURING BAG -  
PS-15/PSA-15**  
Cover for PS-15/PSA-15

---

Code : B00597

---



**TOURING BAG -  
PS-12/PSA-12**  
Cover for PS-12, PSA-12, PPA-121

---

Code : B00596

---



PS-15	PS-12	PS-10	PS-08
Output power: 300W RMS / 600W max.	Output power: 200W RMS / 400W max.	Output power: 160W RMS / 320W max.	Output power: 120 W RMS / 240W max.
Frequency response: 45 Hz - 20 KHz	Frequency response: 45 Hz - 20 KHz	Frequency response: 60 Hz - 20 KHz	Frequency response: 70 Hz - 20 KHz
Impedance: 8 Ω	Impedance: 8 Ω	Impedance: 8 Ω	Impedance: 8 Ω
Dimensions: 680 x 470 x 400 mm	Dimensions: 580 x 420 x 310 mm	Dimensions: 500 x 355 x 270 mm	Dimensions: 402 x 290 x 220 mm
Net weight: 19.8 Kg	Net weight: 13.2 Kg	Net weight: 10.3 Kg	Net weight: 6.6 kg



# PASSIVE SPEAKERS



**iLINE83**  
160W column/ 16 Ω with 4 HP 3" for installation

Code : H10756



**iLINE83sup**  
Wall bracket for iLINE83 column

Code : H10757



**iLINE43**  
80W column/ 8 Ω with 4 HP 3" for installation

Code : H10754



**iLINE43sup**  
Wall bracket for iLINE43 column

Code : H10755



**CUBsat4**  
Head of 30W RMS mini line array

Code : H10663



**iLINE23**  
40W column/ 16 Ω with 2 HP 3" for installation

Code : H10752



**iLINE23sup**  
Wall bracket for iLINE23 column

Code : H10753



**iLINE24sup**  
Adjustable wall bracket for iLINE23 and iLINE43

Code : H10773



**HL-4**  
2x4" mini line array head + TWT ribbon

Code : H10518



	iLINE23	iLINE43	iLINE83	CUBSAT4	HL-4
Power	40W RMS / 80W MAX	80W RMS / 160W MAX	160W RMS / 320W MAX	300W RMS - 600W max	100W RMS - 200W max
Response Response	135 HZ / 17 KHZ	135 HZ / 17 KHZ	135 HZ / 17 KHZ	50Hz - 800Hz	150 Hz - 25 KHz
Sensitivity	89 DB / 108 DB MAX	92 DB / 114 DB MAX	95 DB / 120 DB MAX	124 dB	121 dB
Impedance	16Ω	8Ω	16Ω	4 Ω	16 Ω
Speakers	2X3"	4X3"	8X3"	1X4" + 3X0.5"	2X4" + RIBBON
Dispersion HxV	115° / 20°	115° / 20°	115° / 20°	110° / 20°	120° x 30° to 90°
Dimensions	110X180X148 mm	110X350X148 mm	110X690X148 mm	250 x 510 x 540 mm	485x135x260 mm
Weight	2.2 kg	4 kg	7.6 kg	18.5 kg	5.2 kg

# S SERIES PASSIVE SPEAKERS



**S6**  
Passive 6.5P 80W RMS monitor - black

Code : H9689



**S6W**  
Passive 6.5P 80W RMS monitor - white

Code : H9690



**S8**  
Passive 8P 120W RMS monitor - black

Code : H9691

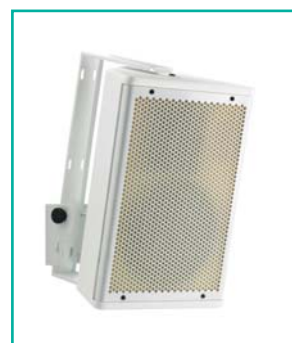

**S8W**  
Passive 8P 120W RMS monitor - white

Code : H9692



**S10**  
Passive 10P 250W RMS monitor - black

Code : H9693



**S10W**  
Passive 10P 250W RMS monitor - white

Code : H9694



**ISX-10 (pair)**  
Compact 2-channel trapezoidal speaker  
Price for the pair

Code : B00619



**ISX-5 (pair)**  
Compact 2-channel trapezoidal speaker  
Price for the pair

Code : B00618



## Hanging brackets:

SUPS6	Hanging bracket for S6 satellite - black	H9705
SUPS6w	Hanging bracket for S6 satellite	H9706
SUPS8	Hanging bracket for S8 satellite - black	H9707
SUPS8w	Hanging bracket for S8 satellite - white	H9708
SUPS10	Hanging bracket for S10 satellite - black	H9709
SUPS10w	Hanging bracket for S10 satellite - white	H9710

	S6	S8	S10	ISX-10 (UNIT)	ISX-5 (UNIT)
Power	100W RMS / 200W MAX	150W RMS / 300W MAX	250W RMS / 500W MAX	160 W RMS	80 W RMS
Frequency response	80 HZ / 20 KHZ	80 HZ / 19 KHZ	75 HZ / 19 KHZ	100 Hz - 20 Khz	120 Hz - 20 Khz
Sensitivity	93 DB / 118 DB MAX	94 DB / 121 DB MAX	96 DB / 126 DB MAX	116	110
Impedance	8Ω	8Ω	8Ω	8Ω	16Ω
Speakers	6.5"	8"	10"	2X5"	5 INCH
Dispersion HxV	90° / 60°	50-100° / 55°	50-100° / 55°	-	-
Dimensions	222 x 365 x 205 mm	280 x 420 x 233 mm	320 x 530 x 280 mm	400 X 200 X 180 mm	285 X 200 X 180 mm
Weight	6.5 kg	10 kg	14.5 kg	15.5 kg	10.5 kg

# SUBWOOFERS



**NEW**

**ATOM18ASUB**  
18-inch active subwoofers with DSP

---

Code : H10783

---



**NEW**

**ATOM15ASUB**  
15-inch active subwoofers with DSP

---

Code : H10782

---



**SRSUB18A**  
18" active 1200W subwoofer with adjustable filter

---

Code : H10713

---



**SRSUB15A**  
15" active 500W subwoofer with adjustable filter

---

Code : H10349

---



**NEW**

**COV-ATOM18ASUB**  
Protective cover for ATOM18ASUB

---

Code : H10788

---



**NEW**

**COV-ATOM15ASUB**  
Protective cover for ATOM15ASUB

---

Code : H10787

---



**COV-SRSUB18A**  
Protective cover for SRSUB18A subwoofer

---

Code : H10887

---



**COV-SRSUB15A**  
Protective cover for SRSUB15A subwoofer

---

Code : H10351

---

	ATOM18ASUB	ATOM15ASUB	SRSUB18A	SRSUB15A
CODE	H10783	H10782	H10713	H10349
Total power	600 W RMS - 2000 W DYNAMIC	600 W RMS - 2000 W DYNAMIC	600 W RMS - 1200 MAX	
Amplification class	D	D	D	D
Power supply	SMPS switched-mode	SMPS switched-mode	SMPS switched-mode	SMPS switched-mode
Protection	Limiter, thermal and short-circuit	Limiter, thermal and short-circuit	Limiter, thermal and short-circuit	Limiter, thermal and short-circuit
Frequency response	35 Hz to 150 Hz	45 Hz to 160 KHz	60 Hz to 150 KHz	60 Hz to 160 KHz
SPL pressure	127 dB max	126 dB max	127 dB max	125 dB max
Woofer	18" of 4" coil	15" of 4" coil	18" of 4" coil	15" of 4" coil
Pre-amplification	Line Inputs for XLR/Jack Combo	Line Inputs for XLR/Jack Combo	Line Inputs for XLR/Jack Combo	Line Inputs for XLR/Jack Combo
	Line Outputs on XLR	Line Outputs on XLR	Line Outputs on XLR	Line Outputs on XLR
	Volume adjustment	Volume adjustment	Volume adjustment 60 to 150 Hz adjustable filter	Volume adjustment 60 to 150 Hz adjustable filter
DSP	Equalisation presets: Normal, Enforce Position presets: Normal, Cardioid, Endfire Extension from 0 to 15 m Normal or inverted polarity Filtering: 60/80/100/120/150 Hz + high output for ATOM 10A/12A/15A		-	-
Dimensions (H x W x D)	662 x 510 x 615 mm	612 x 430 x 595 mm	770 x 680 x 560 mm	702 x 560 x 472 mm
Net weight	38 kg	30.3 kg	39 kg	34 kg



**NEW**

**ATOM-WHEELS**  
4-wheel kit for ATOMSUB subwoofer

---

Code : H10875

---



**iLINEsub12P**  
12" passive subwoofer- 400W - 8 Ω

---

Code : H10763

---

Power rating: 400 W RMS/800 W max  
Frequency response: 50 Hz - 200 Hz  
Axial sensitivity (1W/1m) : 96 dB  
Max. SPL: 125 dB  
Nominal impedance: 8 Ω  
Speakers: 12 inch  
Dimensions: 350 x 515 x 490 mm  
Net weight: 22 Kg

Connectors:  
- Input: Speakon 4 points output  
- 1+/1- : Broadband output  
- 2+/2- : Bass output:



**iLINEsub12A**  
12" active subwoofer 700W + 700W with built-in DSP

---

Code : H10761

---

Power rating: 700W / 4Ω + 700W / 4Ω  
Frequency response: 50 Hz - 200 Hz  
Axial sensitivity (1W/1m) : 96 dB  
Max. SPL: 124 dB  
Nominal impedance: 8 Ω  
Loudspeaker: 12 inch  
Size: 350 x 515 x 490 mm  
Net weight: 23.5 Kg

Amplification:  
- Total available power 700+700 W RMS / 4Ω :  
- Broadband outputs: 700W RMS / 4Ω .  
- Bass outputs: 350W RMS / 8Ω. + 350W RMS / 8Ω internal



**iLINEbox**  
USB → RJ45 converter for DSP of iLINEsub12A

---

Code : H10762

---

DSP : 28/56 bit, 50 MIPS  
Setting the system via the supplied software  
Connectors:  
- RJ45  
- USB B  
Dimensions: 56 x 58 x 23 mm  
Weight: 65 g

Delivered with USB A/USB B cord



**iLINEcov**  
Protective cover for iLINE series subwoofers

---

Code : H10768

---



**HL-8ASUB**  
Subwoofer for active compact line array 2 x 8" - 300W RMS

---

Code : H10519

---

General features  
Power rating: 300W RMS - 600W max  
Frequency response: 80 - 200Hz  
SPL max. (@1m) : 110 dB  
Nominal impedance: 4 Ω  
Woofer: 2 x 8 inches  
Dimensions: 485 x 540 x 260 mm  
Net weight: 19.2 kg

Amplification Class D  
Low level: 2 x 200W RMS / 8 Ω  
Mid/high level 2 x 200W RMS / 8 Ω



**HL-10ASUB**  
Subwoofer for active compact line array 2 x 10" - 400W RMS

---

Code : H10520

---

General features  
Power rating: 400W RMS - 800W max  
Frequency response: 50 - 200Hz  
SPL max. (@1m) : 114 dB  
Nominal impedance: 4 Ω  
Woofer: 2 x 10 inches  
Dimensions: 485 x 540 x 310 mm  
Net weight: 29.2 kg

Amplification Class D  
Low level: 2 x 320W RMS / 8 Ω  
Mid/high level 2 x 200W RMS / 8 Ω



**HL-BUMPER**  
Suspension frame for hanging the complete line array

---

Code : H10521

---

Can hang a maximum of 8 heads and 2 subwoofers  
Maximum weight supported: 110 kg

# SUBWOOFERS

- Passive subwoofers for high-end performance
- Designed, developed and manufactured in Europe
- FAITAL brand components with Neodymium magnet, high quality Baltic birch plywood and coating of polyurethane "Chemline" (USA) anti-scratch paint
- 2400W AES



**SQ-218**  
2x 18" 2400W aes subwoofers

---

Code : B09189

---



**SQ-215**  
2x 15" 2400W aes subwoofers

---

Code : B09188

---



**SQ-212**  
2x 12" 2400W aes subwoofers

---

Code : B09187

---



	<b>SQ-218</b>	<b>SQ-215</b>	<b>SQ-212</b>
CODE	B09189	B09188	B09187
Total power	2400 W AES	2400 W AES	2400 W AES
Impedance	4 Ω	4 Ω	4 Ω
Bass frequency limit	25 Hz	30 Hz	35 Hz
SPL pressure	102 dB 1W/1m - 146 dB max	101 dB 1W/1m - 145 dB max	101 dB 1W/1m - 135 dB max
Woofer	2x18" Faital	2x15" Faital	2x12" Faital
Dimensions (H x W x D)	1180 x 800 x 560 mm	800 x 800 x 540 mm	600 x 600 x 400 mm
Net weight	80 kg	60 kg	38.2 kg

More information on: [www.synq-audio.com](http://www.synq-audio.com)



### MTSub12A

400W amplified subwoofer - Bass reflex

Code : H10078



Total power of amp: 400 W RMS / 800 W Max :  
 SMPS switched mode power supply  
 Frequency response: 50 Hz to 180 Hz  
 SPL acoustic pressure: 124 dB max  
 Woofer : 12", 4 Ω, 400 W RMS  
 1 stereo line input on XLR and RCA  
 1 stereo line output on XLR  
 Volume adjustment  
 Adjusting the low cut-off frequency of the sub: from 80 to 180 Hz  
 Low cut filter [OFF-80-125] for satellite output  
 Phase correction 0-180  
 Protections: CC, thermal and limiter  
 Dimensions: 469 x 489 x 360 mm  
 Net weight: 21.6 kg



### CPX-1510SUB

15" active subwoofer with 2x100W active output

Code : B00612



Power rating: 300 + 200 RMS  
 Frequency response: 35 - 20000Hz  
 SPL max. (@1m) : 128 dB  
 Woofer: 15 inch  
 Dimensions: 440 x 600 x 590 mm  
 Net weight: 42.8 kg

Amplification  
 Low level: 1x 300W RMS  
 Mid/high level: 2x 100W RMS  
 Adjustments: Satellite volume + subwoofer volume



### RS-218B

Subwoofer equipped with two 18" high power and compact speakers.

Code : B00636



Nominal RMS power: 2x 600W  
 Nominal PEAK power: 2x 1200W  
 Nominal impedance: 2x 8Ω  
 Parallel mode:  
 Nominal RMS power: 1x 1200W  
 Nominal PEAK power: 1x 2400W  
 Nominal impedance: 1x 4Ω  
 Frequency response: 35 - 300Hz  
 Sensitivity (1W/1m): 104dB  
 Max. SPL: 138dB  
 Dimensions (WxDxH):  
 1200 x 700 x 565 mm  
 Weight (net): 84 kg



### Ex15S

15" 600W passive subwoofer

Code : H9701



Power: 600 W RMS / 1200 W peak  
 Frequency response [-3 dB] :  
 50 Hz - 200 Hz  
 Impedance: 8 Ω  
 Sensitivity 1 W/1 m : 99 dB / 132 dB SPL  
 Woofer : 15" aluminium frame with 100 mm coil  
 Connectors: Speakon x 2 (1+1- full range)  
 Dimensions (H x W x D) :  
 450 x 560 x 635  
 Net weight: 31 kg



### VIBE18-SUB Mk2

Pro subwoofer: 18" - 600Wrms / 8Ω

Code : B00695



Power rating: 600W RMS  
 Frequency response: 30Hz -250 Hz  
 SPL max. (@1m) : 131 dB  
 Nominal impedance: 8 Ω  
 Woofer: 18" aluminium  
 Connectors: 2 speakon  
 Dimensions: 590 x 736 x 756 mm  
 Net weight: 57 kg



### VIBE15-SUB Mk2

Pro subwoofer: 15" - 400Wrms / 8Ω

Code : B00694



Power rating: 400W RMS  
 Frequency response: 40Hz -300 Hz  
 SPL max. (@1m) : 124 dB  
 Nominal impedance: 8 Ω  
 Woofer: 15" aluminium  
 Connectors: 2 speakon  
 Dimensions: 440 x 595 x 605 mm  
 Net weight: 32.5 kg



# SUBWOOFERS



**TOURING BAG -  
Vibe 15 SUB**  
Travel bag for Vibe 15 SUB

Code : B00594



High-performance protective cover for Series Vibe models.



**TOURING BAG -  
Vibe 18 SUB**  
Travel bag for Vibe 18 SUB

Code : B00595



High-performance protective cover for Series Vibe models.



**ISX-15S**  
Subwoofer 15": 2x350Wrms / 2x 4 Ω

Code : B00620



Power rating: 2x 350W RMS  
Frequency response: 45Hz -250Hz  
Built-in 2-channel 150Hz filter  
SPL max. (l@1m) : 124 dB  
Nominal impedance: 2x4 Ω  
Woofer: 2x15" double coil  
Connectors: 2 x input and output terminal block  
Dimensions: 340 x 680 x 470 mm  
Net weight: 30.4 kg



**CUBsub112**  
12" 300W passive subwoofer

Code : H10664



Power rating: 300W RMS - 600W max  
Frequency response: 45Hz -2.8KHz  
Filter: the subwoofer is not equipped with a passive filter  
SPL max. (l@1m) : 125 dB  
Nominal impedance: 8 Ω  
Woofer: 12" to 64 mm coil  
Connectors: 2 speakon and terminal block for In/Out  
Dimensions: 350 x 500 x 540 mm  
Net weight: 20 kg



**CUBsub208**  
Passive subwoofer to 2 HP from 8" 300W RMS

Code : H10665



Power rating: 300W RMS - 600W max  
Frequency response: 50Hz -800Hz  
Filter: The subwoofer is not equipped with a passive filter  
SPL max. (l@1m) : 124 dB  
Nominal impedance: 4 Ω  
Woofer: 2 x 8" to 50 mm coil  
Connectors: 2 x speakon and terminal block for In/Out  
Dimensions: 250 x 510 x 540 mm  
Net weight: 18.5 kg



**CB-210**  
Subwoofer 2 x 10" - 300W

Code : H9256



Power handling: 300 W RMS / 600 W max.  
Frequency response (+/-3 dB) : 48 - 160 Hz  
Sensitivity (1 W/1 m) : 96 dB  
Max. SPL: 127 dB  
Loudspeaker: 2 x 26 cm - 50 mm coil  
Nominal impedance: 4 Ω  
Connectors: 2 x Speakon NL4  
1 base for coupling bar  
Dimensions (H x W x D) : 400 x 650 x 445 mm  
Weight: 32 kg



**I-SUB 210**  
SYNQ high power subwoofer 2 x 10" with very compact design.

Code : B00642



Power rating: 500 W RMS  
Frequency response: 50Hz -200Hz  
SPL 1w/1m : 98 dB  
Nominal impedance: 8 Ω  
Woofer: 2x10"  
Connectors: 2 x speakon  
Dimensions: 600 x 350 x 410 mm  
Net weight: 26 kg



### SQ-212 DOLLY

Customised SYNQ trolley for fast and safe SQ subwoofer transport

Code : B09190



### SQ-215 DOLLY

Customised SYNQ trolley for fast and safe SQ subwoofer transport

Code : B09191



### SQ-218 DOLLY

Customised SYNQ trolley for fast and safe SQ subwoofer transport

Code : B09192



### WHEELSET

SYNQ set of wheels for subwoofer Synq (RS and CLS series)

Code : B00637



Custom trolley for fast and safe transportation of SQ subwoofers.  
Thanks to a special robust mechanism, the trolley adapts easily to the front of the subwoofer to protect it.

Set of wheels for the subwoofers Synq (RS and CLS series)



# AMPLIFIERS

The heart of playback, performance and durability, exceptional sound quality. Professional and consumer solutions.



### DSPA-1500

2 x 440W @ 8Ω, 2 x 750W @ 4Ω,  
2 x 1200W @ 2Ω

Code : B00275



### DSPA-1000

2 x 300W @ 8Ω, 2 x 500W @ 4Ω,  
2 x 750W @ 2Ω

Code : B00274



### SMi1500

Amplifier with switched-mode power  
supply 2 x 750W @ 4Ω

Code : H9829



### SMi1000

Amplifier with switched-mode power  
supply 2 x 500W @ 4Ω

Code : H9828



### SMi600

Amplifier with switched-mode power  
supply 2 x 300W @ 4Ω

Code : H9827



### C3-1800

2x 450Wrms + 900Wrms subwoofer @ 4Ω

Code : B00262



	DSPA-1500	DSPA-1000	SMi1500	SMi1000	SMi600	C3-1800
Power	<ul style="list-style-type: none"> <li>- RMS stereo</li> <li>4Ω: 2 x 750W</li> <li>4Ω: 2 x 440 W</li> <li>2Ω: 2 x 1200 W</li> </ul> <ul style="list-style-type: none"> <li>- Bridged mono</li> <li>8Ω: 1 x 1500 W</li> <li>4Ω: 1 x 2400 W</li> </ul>	<ul style="list-style-type: none"> <li>- RMS stereo</li> <li>4Ω: 2 x 500 W</li> <li>8Ω: 2 x 300 W</li> <li>2Ω: 2 x 750W</li> </ul> <ul style="list-style-type: none"> <li>- Bridged mono</li> <li>8Ω: 1 x 1000 W</li> <li>4Ω: 1 x 1500 W</li> </ul>	<ul style="list-style-type: none"> <li>- RMS stereo</li> <li>4Ω: 2 x 750W</li> <li>8Ω: 2 x 450 W</li> <li>2Ω: 2 x 1000 W</li> </ul> <ul style="list-style-type: none"> <li>- Bridged mono</li> <li>8Ω: 1 x 1500 W</li> <li>4Ω: 1 x 2000 W</li> </ul>	<ul style="list-style-type: none"> <li>- RMS stereo</li> <li>4Ω: 2 x 500W</li> <li>8Ω: 2 x 310 W</li> <li>2Ω: 2 x 600 W</li> </ul> <ul style="list-style-type: none"> <li>- Bridged mono</li> <li>8Ω: 1 x 1000 W</li> <li>4Ω: 1 x 1200 W</li> </ul>	<ul style="list-style-type: none"> <li>- RMS stereo</li> <li>4Ω: 2 x 300 W</li> <li>8Ω: 2 x 200 W</li> <li>2Ω: 2 x 450 W</li> </ul> <ul style="list-style-type: none"> <li>- Bridged mono</li> <li>8Ω: 1 x 600 W</li> <li>4Ω: 1 x 900 W</li> </ul>	<ul style="list-style-type: none"> <li>- RMS stereo</li> <li>4Ω: 2 x 450W RMS</li> <li>8Ω: 2 x 300 W RMS</li> </ul> <ul style="list-style-type: none"> <li>Subwoofer:</li> <li>4Ω: 1 x 900 W RMS</li> <li>8Ω: 1 x 600 W RMS</li> </ul>
Type of amplification	Class D	Class D	Class 2H	Class AB	Class AB	Class AB
Damping factor	200	200	200	200	100	500
Cooling	Front-to-back regulated ventilation					
Connectors	<ul style="list-style-type: none"> <li>- Input: Balanced combo (XLR + TRS jack) connector</li> <li>- Output: Screw-on terminals + 4-pole Speakon®</li> </ul>		<ul style="list-style-type: none"> <li>- Input: XLR + Jack + RCA connectors</li> <li>- Output: Screw-on terminals + 4-pole Speakon®</li> </ul>		<ul style="list-style-type: none"> <li>- Input: XLR connectors</li> <li>- Output: 4-Pole Speakon®</li> </ul>	
Protections	<ul style="list-style-type: none"> <li>- Against short-circuits</li> <li>- Signal and current limiter</li> <li>- Against voltage deviations</li> <li>- Thermal protection</li> </ul>		<ul style="list-style-type: none"> <li>- Against short-circuits</li> <li>- Current limiter</li> <li>- Against voltage deviations</li> <li>- Immunity to radio frequencies</li> <li>- Thermal protection and regulation</li> </ul>		<ul style="list-style-type: none"> <li>- Limiter</li> <li>- Against short-circuits</li> <li>- Against overloads and DC</li> <li>- Thermal protection and regulation</li> </ul>	
DSP	HPF, LPF, PEQ, Q, Limiter, Delays, filters.					
Dimensions (L x W x H)	19" x 2U (482 x 88 x 280mm)		19" x 2 U: 483 x 89 x 395mm		19" x 2 U: 483 x 89 x 473 mm	
Weight	5.2kg	4.9 kg	9.2 kg	6.9 kg	6 kg	24 kg





**DIGIT 3K6**  
2 x 1,800Wrms / 4Ω, class D

Code : B00267

**DIGIT 2K2**  
2 x 1,100Wrms / 4Ω, class D

Code : B00266

**DIGIT 1K0**  
2 x 540Wrms / 4Ω, class D

Code : B00268

	DIGIT 3K6	DIGIT 2K2	DIGIT 1K0
Power	<ul style="list-style-type: none"> <li>- RMS stereo 4Ω : 2 x 1800 W 8 Ω : 2 x 1050 W</li> <li>- Bridged mono 8 Ω : 1 x 3600W</li> </ul>	<ul style="list-style-type: none"> <li>- RMS stereo 4Ω : 2 x 1100 W 8 Ω : 2 x 650 W</li> <li>- Bridged mono 8 Ω : 1 x 2200W</li> </ul>	<ul style="list-style-type: none"> <li>- RMS stereo 4Ω : 2 x 540 W 8 Ω : 2 x 300 W</li> <li>- Bridged mono 8 Ω : 1 x 1080W</li> </ul>
Type of amplification	Class D	Class D	Class D
Damping factor	300	300	280
Cooling	Front-to-back regulated ventilation		
Connectors	<ul style="list-style-type: none"> <li>- Input: XLR/Jack combo connectors</li> <li>- Output: 4-Pole Speakon®</li> </ul>		
Protections	<ul style="list-style-type: none"> <li>- Against short-circuits</li> <li>- Signal + current limiter</li> <li>- Against overloads</li> <li>- Thermal protection</li> <li>- AC, VHF protection</li> </ul>		
Dimensions [L x W x H]	19" x 1 U: 483 x 44 x 301 mm		19" x 1 U: 483 x 44 x 301 mm
Weight	5.6 kg	5.5 kg	3.3 kg

# AMPLIFIERS

			
<b>AMP 400.2</b> 2 x 400Wrms / 4Ω	<b>AMP 200.2</b> 2 x 200Wrms / 4Ω	<b>AMP 100.2</b> 2 x 100Wrms / 4Ω	<b>AMP 150.4</b> 4 x 150W @ 4Ω
Code : B00272	Code : B00271	Code : B00270	Code : B00273
			

		
<b>Ti500</b> Class D Amplifier 1 unit 2 x 250W @ 4Ω or 1 x 500W @ 8Ω	<b>Ti300</b> Class D Amplifier 1 unit 2 x 150W @ 4Ω or 1 x 300W @ 8Ω	<b>Ti154</b> Class D Amplifier 1 unit 4 x 150W @ 4Ω or 2 x 300W @ 8Ω
Code : H9673	Code : H9672	Code : H10412
		

	AMP 400.2	AMP 200.2	AMP 100.2	AMP 150.4	Ti500	Ti300	Ti154
Power	- RMS stereo 4Ω: 2 x 400 W 8 Ω : 2 x 250 W  - Bridged mono 8 Ω : 1 x 800W	- RMS stereo 4Ω: 2 x 200 W 8 Ω : 2 x 130 W  - Bridged mono 8 Ω : 1 x 400W	- RMS stereo 4Ω: 2 x 100 W 8 Ω : 2 x 70 W  - Bridged mono 8 Ω : 1 x 200W	4Ω: 4 x 150 W RMS 8 Ω : 4 x 80 W RMS	- RMS stereo 4Ω: 2 x 250 W 8 Ω : 2 x 130 W  - Bridged mono 8 Ω : 1 x 500W	- RMS stereo 4Ω: 2 x 150 W 8 Ω : 2 x 80 W  - Bridged mono 8 Ω : 1 x 300W	4Ω: 4 x 150 W RMS 8 Ω : 4 x 80 W RMS
Type of amplification	Class D						
Cooling	Front-to-back regulated ventilation						
Connectors	- Input: XLR connectors - Output: 4-Pole Speakon®	- Input: XLR+jack connectors  - Output: 4-Pole Speakon®	- Input: XLR/Jack combo connectors - Output: 4-pole Speakon® + terminal blocks				
Protections	- Against short-circuits - Signal + current limiter - Against overloads - Thermal protection						
Dimensions (L x W x H)	19" x 1U 483 x 44 x 310 mm	19 inches x 1U: 483 x 44 x 225 mm	19 inches x 1U: 483 x 44 x 225 mm	19 inches x 1U: 483 x 44 x 330 mm	19 inches x 1U: 483 x 44 x 330 mm	19 inches x 1U: 483 x 44 x 330 mm	19 inches x 1U: 483 x 44 x 330 mm
Weight	5.8 kg	3.7 kg	3.7 kg	5.2kg	4.7 kg	4.3 kg	4.5 kg



			
<b>PE-2400</b> 2 x 1,200Wrms / 4Ω, class H	<b>PE-900</b> 2 x 450Wrms / 4Ω, class H	<b>Wi1800</b> 2 x 900W RMS amplifier @ 4Ω 2 x 600W @ 8Ω - Bridgeable @ 4Ω	<b>Wi1500</b> 2 x 750W RMS amplifier @ 4Ω 2 x 500W @ 8Ω - Bridgeable @ 4Ω
Code : B00265	Code : B00263	Code : H9565	Code : H9564
			
			
<b>Wi1200</b> 2 x 600W RMS amplifier @ 4Ω 2 x 400W @ 8Ω - Bridgeable @ 4Ω	<b>Wi900</b> 2 x 450W RMS amplifier @ 4Ω 2 x 300W @ 8Ω - Bridgeable @ 4Ω	<b>Wi640</b> 2 x 320W RMS amplifier @ 4Ω 2 x 210W @ 8Ω - Bridgeable @ 4Ω	<b>WA-4X3</b> 4 channel amplifier 4 x 300W RMS @ 4Ω
Code : H9563	Code : H9562	Code : H9561	Code : H9066
			

	PE-2400	PE-900	Wi1800	Wi1500	Wi1200	WA-4X3
Power	- RMS stereo 4Ω: 2 x 1200 W 8 Ω : 2 x 800 W 2 Ω : 2 x 1440 W  - Bridged mono 8 Ω : 1 x 2,400W 4Ω: 1 x 2800 W	- RMS stereo 4Ω: 2 x 450 W 8 Ω : 2 x 800 W 2 Ω : 2 x 1440 W  - Bridged mono 8 Ω : 1 x 2,400W 4Ω: 1 x 2800 W	- RMS stereo 4Ω: 2 x 900 W 8 Ω : 2 x 600 W 2 Ω : 2 x 1400 W  - Bridged mono 8 Ω : 1 x 1800 W 4Ω: 1 x 2800 W	- RMS stereo 4Ω: 2 x 750W 8 Ω : 2 x 500 W 2 Ω : 2 x 1200 W  - Bridged mono 8 Ω : 1 x 1400 W 4Ω: 1 x 2400 W	- RMS stereo 4Ω: 2 x 600 W 8 Ω : 2 x 400 W 2 Ω : 2 x 900 W  - Bridged mono 8 Ω : 1 x 1200 W 4Ω: 1 x 1800 W	- RMS stereo 4Ω: 4 x 300 W 8 Ω : 4 x 200 W  - Bridged stereo 8 Ω : 2 x 600 W - 2.1 stereo 8 Ω : 2 x 200 W + 1 x 600W bridged
Type of amplification	Class H	Class H	Class H	Class H	Class AB	Class AB
Damping factor	450	450	350	350	250	200
Cooling	Front-to-back regulated ventilation					
Connectors	- Input: XLR/Jack combo connectors - Output: 4-Pole Speakon®	- Input: XLR/Jack combo connectors - Output: Screw-on terminals + 4-pole Speakon®			- Input: XLR + jack + RCA connectors - Output: Screw-on terminals + 4-pole Speakon®	
Protections	- Against short-circuits and overloads - Automatic current limiter - Against DC current - High-temperature protection		- Against short-circuits - Current limiter - Against voltage deviations - Immunity to radio frequencies - Thermal protection and regulation			
Dimensions [L x W x H]	19" x 2 U: 483 x 89 x 440 mm		19" x 2 U: 483 x 89 x 420 mm			19" x 2 U: 483 x 89 x 375 mm
Weight	25 kg	25 kg	21.2 kg	19.5 kg	19.2 kg	16 kg



# AMPLIFIERS



## VX700 II

Professional amplifier 2 x 350Wrms / 4Ω.

Code : B00295



## VX400 II

Professional amplifier 2 x 200Wrms / 4Ω.

Code : B00294



## VX200 II

Professional amplifier 2 x 110Wrms / 4Ω.

Code : B00293



## AS-620

2 x 300W RMS amplifier

Code : H7593



## AS-420

2 x 200W RMS amplifier

Code : H7578



## AS-220

2 x 120W RMS amplifier

Code : H7577



	VX700 II	VX400 II	VX200 II	AS-620	AS-420	AS-220
Power	- RMS stereo 4Ω: 2 x 350 W 8 Ω : 2 x 200 W  - Bridged mono 8 Ω : 1 x 700 W	- RMS stereo 4Ω: 2 x 200 W 8 Ω : 2 x 135 W	- RMS stereo 4Ω: 2 x 110 W 8 Ω : 2 x 65 W  - Bridged mono 8 Ω : 1 x 220 W	- RMS stereo 4Ω: 2 x 300 W 8 Ω : 2 x 220 W	- RMS stereo 4Ω: 2 x 200 W 8 Ω : 2 x 100 W	- RMS stereo 4Ω: 2 x 120 W 8 Ω : 2 x 75 W
Type of amplification	Class D	Class D	Class D	Class D	Class D	Class D
Damping factor	200	150	150			
Cooling	Front-to-back regulated ventilation					
Connectors	- Input: XLR + jack connectors - Output: Screw-on terminals + 4-pole Speakon®			- Input: Jack connectors - Output: Speakon®		
Protections	- Against short-circuits - Current limiter - Thermal protection and regulation			- Against short-circuits - Against overloads - Thermal protection		
Dimensions (L x W x H)	19" x 2 U: 483 x 89 x 260 mm		19" x 1U 483 x 44 x 320 mm			19" x 2 U: 483 x 89 x 210 mm
Weight	13 kg	9 kg	9.5 kg	14 kg	10 kg	8 kg



**AVM-3**  
Class D amplifier module for VIBE18-SUB Mk2.

---

Code : B00242

---



**AVM-2**  
Class D amplifier module for VIBE15 Mk2, VIBE30 Mk2 and VIBE15-SUB Mk2.

---

Code : B00241

---



**AVM-1**  
Class D amplifier module for VIBE8 Mk2, VIBE10 Mk2 & VIBE12 Mk2

---

Code : B00240

---



	AVM-3	AVM-2	AVM-1
Power	4Ω: 1200W RMS 8 Ω : 800 W RMS	4Ω: 800 W RMS 8 Ω : 500 W RMS	4Ω: 500 W RMS 8 Ω : 300 W RMS
Type of amplification	Class D		
Damping factor	500		
Cooling	Regulated ventilation		
Connectors	- Input: XLR+jack+RCA connectors - Output: Speakon® 1+/1-		
Protections	- Against short-circuits - Signal + current limiter - Against overloads - Thermal protection		
Dimensions (L x W x H)	320 x 160 x 87 mm	320 x 160 x 87 mm	275 x 145 x 72 mm
Weight	3.4 kg	3.4 kg	2 kg

More information on: [www.jb-systems.eu](http://www.jb-systems.eu)

# SOUND PROCESSING

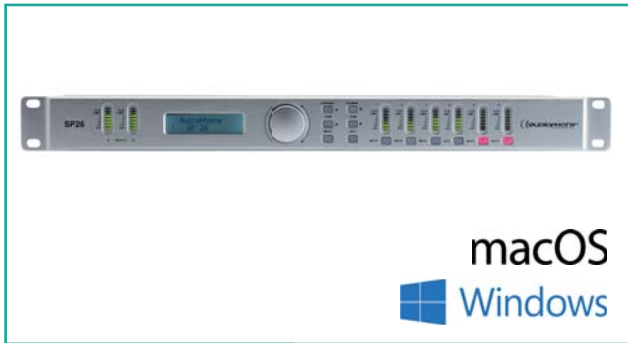

## SP26

2IN6OUT sound processor with software

Code : H10712



Inputs: 2 balanced inputs  
Outputs: 6 balanced outputs  
Sampling rate: 96kHz, 24-bit depth  
Crossover / EQ Operational frequency range: 20Hz – 20kHz  
Crossover filtering: Bessel, Butterworth (6, 12, 24 and 48dB/octave), Linkwitz-Riley (12 and 24dB/octave)  
10-band equaliser: Bell, Notch, All Pass, Band Pass, Low/High Pass, Low/High Shelf  
Equaliser gain : adjustable from -12dB to +12dB  
Equaliser Q: Adjustable from 0.2 to 25  
Phase inversion  
Limiter attack time from 10 to 100  
Limiter threshold from -48dB to 9dB  
Password protection  
50 presets available  
Dimensions (mm): 483 x 127 x 45 (1U)  
Weight: 3kg



## Q215

2x15-band equaliser +/- 12dB - 1U

Code : H9670



Stereo equaliser, 2/3 octaves from 31.5Hz to 16kHz  
Adjustable output level: +12/-12 dB  
20mm faders  
Low-cut filter per channel (60Hz -3dB)  
Balanced inputs: XLR, 6.35 TRS jack  
Unbalanced inputs: RCA  
Balanced outputs: XLR, 6.35 TRS jack  
Unbalanced outputs: RCA  
Recording output (REC OUT) on unbalanced RCA (output level -6 DB)  
Signal level indicator: -10DB, 0DB, +10DB, +17DB  
Low-cut and bypass indicator  
Dimensions: 483 x 44 x 190 mm  
Weight: 2.4kg



## BEQ-15

2x15-band stereo equaliser.

Code : B00288



2 x 15-band stereo equaliser 2/3 octaves from 25Hz to 16kHz  
Adjustable output level: +/-6dB or +/- 12dB  
20mm faders  
Balanced inputs: XLR, 6.35 TRS jack  
Unbalanced inputs: RCA  
Balanced outputs: XLR, 6.35 TRS jack  
Unbalanced outputs: RCA  
Level switch: 6dB/12dB  
Equaliser bypass switch  
Subsonic filter switch  
< 20Hz  
Dimensions: 483 x 44 x 165 mm  
Weight: 2.5 Kg



## X312

2-way stereo or 3-way mono active filter

Code : H9669



Inputs / outputs on balanced XLR + 4dB  
Stereo (2-way + subwoofer) or mono (3-way + subwoofer) operation  
LOW SUM mode to sum low frequencies from both inputs and output to mono  
Lows, mids and highs phase reversal possible  
In stereo mode:  
- Adjustment of cut-off frequency between highs and lows for each side (45 to 960Hz)  
In mono mode:  
- Adjustment of cut-off frequency between highs, mids and lows (45 to 960Hz and 450 to 9,600Hz)  
- Optional use of SUB output with adjustable level and cut-off frequency (20 to 200Hz)  
Dimensions: 483 x 175 x 44mm  
Weight: 2kg



## XO 2.4

Active filter: 2-way stereo or 3-way mono.

Code : B00287



Balanced XLR inputs and outputs  
Stereo or mono operation  
Phase reversal switch  
40Hz subsonic filter (with on/off switch)  
In stereo mode:  
- Adjustment of cut-off frequency between highs and lows for each side (45 to 960Hz)  
In mono mode:  
- Adjustment of cut-off frequency between highs, mids and lows (45 to 960Hz and 450 to 9,600Hz)  
Dimensions: 483 x 136 x 44mm  
Weight: 2kg



## ENH 2.3

Professional multi-band sound enhancer

Code : B00286



Adds harmonics to sound, increasing definition, presence and transparency. Considerably enhances low frequencies (more punch)  
Balanced XLR inputs and outputs  
Separate subwoofer output with adjustable output level and cut-off frequency from 100 to 250Hz.  
Low Mix adjustment for lows HPF from 1 to 8kHz for cut-off frequency  
High Mix adjustment for high-mids  
Phase reversal switch  
CLIP indicator  
Level indicator -40/-20/-6/-2dB  
Dimensions: 483 x 154 x 44mm  
Weight: 1 kg



### SDI-1

Stereo DI-box. Converts unbalanced audio signals into balanced signals

Code : B00279



This stereo DI-box is the perfect solution for various applications!  
It allows conversion of unbalanced audio signals into balanced signals for transport through long cables.  
The "ground lift" switch allows separation of the inputs/outputs to avoid ground loops.  
Solid anodised aluminium black housing  
1 RCA and XLR/6.35 jack combo input  
1 XLR output  
Max. input level: +21dBu  
Dimensions: 105 x 110 x 44 mm  
Weight: 0.440 Kg



### BDA-100

Active direct box

Code : H7678



1 unbalanced 6.35 jack input  
1 balanced XLR input  
1 XLR output  
Max. input level: 0/+20/+40dB  
Dimensions: 135 x 55 x 130 mm  
Weight: 0.700 Kg  
9V battery not included



### AD-BOX

Analogue/digital converter  
USB - Unbalanced 1IN/1OUT

Code : H9268



Works on PC or Mac without specific drivers  
16-bit/48KHz AD-DA converter  
1 input / 1 output  
Combo connector input  
RCA connector output  
Powered by USB port



### CONVERTER

USB/LINE converter and PHONO with Soft

Code : H9077



Provided with Audacity, the French audio processing software  
Comprehensive and efficient tools to optimise the quality of your recording  
Simple user interface, allowing to record vinyl records at high speed.  
Plug-and-play and driverless operation with most audio software on the market.  
2 RCA inputs (L and R), line/phono switch  
- 2 RCA outputs (L and R), line level  
Cable length: 1.5m



### BT10ER

Bluetooth transmitter-receiver

Code : H10015



Bluetooth® : 3.0  
Supported Bluetooth®profiles: apt-X, A2DP and AVRCP  
Apt-x® decoder Low Latency 32ms  
Operating distance:  
10 metres on average - Class 2  
Battery life 9 to 10 hours on average  
Battery: Lithium-polymer 270mAh  
Weight: 48.5g  
Dimensions: 50 x 37 x 13 mm



### BT2xE

Double stereo audio Bluetooth transmitter

Code : H10413



Bluetooth® 4.1  
Bluetooth®profile: A2DP  
Audio codecs: aptX-L, aptX, SBS, FastStream  
Operating range: Class 2, 10 meters  
Allows for concurrently pairing two devices  
Operating battery life:  
Up to 8 hours  
Battery: Rechargeable, Li-Po, 250mAh  
Weight: Housing: 23g / Base: 7g  
Dimensions: 48 x 48 x 15 mm



### BT-20R

Bluetooth® receiver HD  
3.5 jack output + USB charger

Code : H10305



Bluetooth® 4.2  
Supported Bluetooth®profiles: apt-X, A2DP and AVRCP  
Apt-x® decoder Low Latency 32ms  
Operating distance:  
10 metres on average - Class 2  
Power supply: AC100-240V 50/60Hz  
USB output current: 5V / 1A / 5W  
3.5mm jack and RCA cable included

# MIXERS

A mix of genres. This range of mixers offers a solution for each use: Ultra-compact mixers for DJs, multiple-input and output consoles, and live consoles with perfectly transparent preamps for optimal playback for optimal sound quality.



**SMP 16.42**  
16-channel PA mixer with very low background noise architecture

---

Code : B00152

---



16-channel mixer with 4 sub-groups and 2 standalone sub-masters .  
DSP 24-bit effects processor with 100 presets  
Digital audio input/output through USB type B

Inputs:  
12 channels with balanced inputs, 8 mono 4 stereo:  
Input gain  
Mono channel inserts  
Peak indicator @ -5dB  
High-pass filter @ 75Hz  
3-band equaliser with parametric adjustment for mids  
1 AUX send pre (monitoring)  
1 AUX send with pre/post switch  
EFX send for effects selection (post)  
PAN / BAL control  
Mute button for each channel  
PFL inverter  
LEVEL with 60mm control fader  
G/D selection and sub-groups 1-2 3-4  
48-volt phantom power  
Outputs:  
G/D general control, sub-groups, headphones and control room

Footswitch with 6.35 stereo jack (DSP activation)  
2 x 10 sections LED VU-meters  
7-band equaliser for master mix  
19-inch rack brackets included  
Power supply: External  
Net weight: 7.3 Kg  
Dimensions: 436 x 90 x 420 mm



**SMP 12.22**  
12-channel PA mixer with very low background noise architecture.

---

Code : B00151

---



12-channel mixer with 2 sub groups and 2 ALT 3-4 outputs  
DSP 24-bit effects processor with 100 presets  
Digital audio input/output through USB type B

Inputs:  
8 balanced input channels, 4 mono 4 stereo:  
Input gain  
Mono channel inserts  
Peak indicator @ -5dB  
High-pass filter @ 75Hz  
3-band equaliser (12kHz/2.5kHz/80Hz)  
AUX send with pre/post switch  
EFX send for effects selection (post)  
PAN / BAL control  
Mute button for channels ALT 3-4  
LEVEL with 60mm control fader  
48-volt phantom power  
Outputs:  
G/D general control, headphones and control room

Footswitch with 6.35 stereo jack (DSP activation)  
2 x 10 sections LED VU-meters  
19-inch rack brackets included  
Power supply: External  
Net weight: 6.4 Kg  
Dimensions: 328 x 90 x 420 mm



**SMP 8.2**  
8-channel PA mixer with very low background noise architecture.

---

Code : B00150

---



8-channel mixer  
DSP 24-bit effects processor with 100 presets  
Digital audio input/output through USB type B

Inputs:  
4 balanced mic input channels, 2 line mono 3 line stereo:  
Input gain  
Mono channel inserts  
Peak indicator @ -5dB  
High-pass filter @ 75Hz  
3-band equaliser  
1 AUX send  
EFX send for effects selection (post)  
PAN / BAL control  
PFL inverter  
Output level adjustment  
Outputs:  
G/D general control, headphones and control room

Footswitch with 6.35 stereo jack (DSP activation)  
2 x 10 sections LED VU-meters  
Power supply: External  
Net weight: 3.3 Kg  
Dimensions: 249 x 75 x 295 mm



### MX1624

Live Mixer 10 microphones + 2 line + 24-bit DSP 10 FX with USB port

Code : H9560



8 mono / 4 stereo / 10 mic input mixer  
24-bit DSP effects processor with 10 presets  
Digital audio input/output through USB type B

#### Input adjustments:

Gain / 3-band equaliser / AUX with Pre/ Post switch/ Effects / Balance / Mute / PFL / High-pass filter 75Hz

#### Output adjustments:

Master level / ALT 3/4 / AUX send, AUX return and EFX return / Headphones and Control Room  
Phantom power  
Effect selector with level adjustment

#### Outputs

Master through 2x XLR and 2x 6.35 stereo jacks  
ALT 3/4 through 2x 6.35 stereo jacks  
AUX outputs, Control Room and headphones through 6.35 stereo jacks  
Record output through RCA

Footswitch with 6.35 stereo jack (DSP activation)

19-inch rack brackets included  
Power supply: External  
Net weight: 5.6 Kg  
Dimensions: 436 x 420 x 65 mm



### MX1224

Live Mixer 6 microphones + 2 line + 24-bit DSP 10 FX with USB port

Code : H9559



4 mono / 2 mono/stereo and 2-way stereo mixer  
24-bit DSP effects processor with 10 presets  
Digital audio input/output through USB type B

#### Input adjustments:

Gain / 3-band equaliser / AUX with Pre/ Post switch/ Effects / Balance / Mute / PFL / High-pass filter 75Hz

#### Output adjustments:

Master level / ALT 3/4 / AUX send, AUX return and EFX return / Headphones and Control Room  
Phantom power  
Effect selector with level adjustment

#### Outputs:

Master through 2x XLR and 2x 6.35 stereo jacks  
ALT 3/4 through 2x 6.35 stereo jacks  
AUX outputs, Control Room and headphones through 6.35 stereo jacks  
Record output through RCA

Footswitch with 6.35 stereo jack (DSP activation)

2 x 10 sections LED VU-meters  
19-inch rack brackets included  
Power supply: External  
Net weight: 3.4 Kg  
Dimensions: 328 x 420 x 65 mm



### MX822

Live Mixer 4 microphones + 1 line + 24-bit DSP 10 FX with USB port

Code : H9558



2 mono / 2 mono/stereo and 1-way stereo mixer  
24-bit DSP effects processor with 10 presets  
Digital audio input/output through USB type B

#### Input adjustments:

Gain / 3-band equaliser / AUX / Effects / Balance / High-pass filter 75Hz

#### Output adjustments:

Master level / AUX return and EFX / Headphone  
Phantom power  
Effect selector with level adjustment

#### Outputs:

Master through 6.35 stereo jack  
AUX outputs and headphones through 6.35 stereo jack  
Record output through RCA

Footswitch with 6.35 stereo jack (DSP activation)

2 x 10 sections LED VU-meters  
Power supply: External  
Net weight: 2.8 Kg  
Dimensions: 247 x 290 x 65 mm





# MIXERS



## MIX 5.2

Mixer with 5 channels and 2 independent zones.

Code : B00119



**Inputs**  
1 microphone with Talkover on front panel  
5 microphones on back  
4 line  
2 phono

**Adjustments**  
3-band equaliser on each output  
3-band equaliser on microphone channel 1  
Gain adjustment for each channel  
Talkover level adjustment  
Choice of zone A or B per channel

**Outputs**  
Master A balanced and unbalanced  
Master B balanced and unbalanced  
Separate records A and B

LED VU-meters with 10 sections  
Power supply: AC 230V ~ 50Hz  
Dimensions: 483 x 134 x 130 mm  
Weight: 2 Kg



## MIX6usb

A compact and robust 19" mixer with stylish black design (white and blue LEDs).

Code : B00122



**Inputs**  
1 USB port on channel 1 for playing and recording audio files  
2 microphones with Talkover  
5 lines,  
2 phono or 2 line,  
1 USB  
Aux on front panel

**Adjustments**  
3-band equaliser on each channel  
Gain adjustment for each channel  
Talkover level adjustment

**Outputs**  
Balanced Master  
Separate Booth and Record  
1 USB port

LED VU-meters with 10 sections  
Power supply: AC 230V ~ 50Hz  
Dimensions: 483 x 179 x 104 mm  
Weight: 5.1 Kg



## SMI-84

An ideal mixer for any pub, bar, hotel, restaurant, etc.

Code : B00123



Mixing console with 4 zones  
- 2 USB ports  
- 6 lines through RCA  
- 2 phono  
- 2 microphones with Talkover  
- 1 Aux on front panel  
Level adjustment on front panel  
Microphone equaliser on front panel  
Output equaliser on back

**Outputs**  
Zone A, B, C through XLR mono  
Stereo Master through XLR and RCA  
All outputs are also Euroblock connectors  
Mute key on Euroblock  
Priority input on Euroblock  
2 USB ports allowing playback and recording via a computer

Power supply: AC 230V ~ 50Hz  
Dimensions: 483 x 134 x 184 mm  
Weight: 4.2 Kg



## MYA8C

4-channel console + 3 mic + 2 USB

Code : H9880



**Inputs**  
- 1 USB port on channel 6 allowing playback and recording through a computer  
- 2 phono through RCA  
- 7 lines through RCA  
- 2 microphones through combo connector on front panel  
- 1 microphone through jack connector on back  
- 1 mini-jack auxiliary input on front panel

**Adjustments**  
- 3-band equaliser on stereo channels  
- 3-band equaliser on microphone channels  
- Gain adjustment for each channel

**Outputs**  
- Master A balanced and unbalanced output  
- Master B unbalanced output  
- Record output  
- Pre-listen output on 6.35 stereo jack  
- 1 USB audio port to connect to a computer

LED VU-meter for Master output and on each phono/line-level channel  
Talkover on all microphone channels  
Power supply: AC 230V ~ 50Hz  
Dimensions: 483 x 264 x 104mm (85mm-deep flush-mounting)  
Weight: 4.5 Kg





### MYA5D

4-channel mixers phono/line/microphone and 1 USB port

Code : H9879



#### Inputs

- 1 USB port on channel 4 allowing playback and recording through a computer
- 2 phono through RCA
- 4 lines through RCA
- 1 microphone through combo connector on front panel
- 1 microphone through jack connector on back

#### Adjustments

- 3-band equaliser on stereo channels
- 3-band equaliser on microphone channels
- Gain adjustment for each channel

#### Outputs

- Master A balanced and unbalanced output
- Master B unbalanced output
- Record output
- Pre-listen output on 6.35 stereo jack
- 1 USB audio port to connect to a computer

LED VU-meters on each channel and Master

Power supply: AC 230V ~ 50Hz  
Dimensions: 254 x 295 x 104mm  
[85mm-deep flush-mounting]  
Weight: 3.4 Kg



### BATTLE4-usb

DJ Mixer, 9 inputs on 4 channels [3 line inputs, 2 phono, 2 microphones, 2 USB]

Code : B00126



#### Inputs

- 2 USB ports on channels 2 and 3 allowing playback and recording of audio files
- 3 line inputs
- 2 phono
- 2 microphones

#### Adjustments

- 3-band equaliser on each channel
- 2-band equaliser on microphone channel
- Gain adjustment for each channel

#### Outputs

- Balanced Master
- Separate Booth and Record
- 2 USB ports

Master LED VU-meters per channel  
Power supply: AC 230V ~ 50Hz  
Dimensions: 237 x 315 x 105 mm  
Weight: 3.3 Kg



### DIGITAL-3

3-channel mixer with 1 microphone and 2 USB

Code : H9254



#### Inputs

- 2 USB ports on channels 1 and 3 allowing playback and recording of audio files
- 3 phono through RCA
- 3 line through RCA
- 1 microphone through jack with Talkover

#### Adjustments

- 3-band equaliser on each channel
- 2-band equaliser on microphone channel
- Gain adjustment for each channel

#### Outputs

- Master output, high level
- 2 USB ports

On/off switch  
LED VU-meter for Master  
External power supply  
Dimensions: 254 x 308 x 82.5 mm  
Weight: 3.4 kg



### DIGITAL-2

2-channel DJ Mixer with 1 microphone and 2 USB

Code : H8682



#### Inputs

- 2 USB ports allowing playback and recording of audio files
- 2 PHONO inputs with switchable RCA connectors
- 2 LINE inputs with switchable RCA connectors
- 1 DJ mic input with jack connector and TALKOVER

#### Adjustments

- Low/mid correction -12/+12 dB through DJmic channel
- Gain and lows/mids/highs correction -15/+15 on stereo channels

#### Outputs

- Unbalanced Master output through RCA
- Headphone output
- 2 USB ports

General LED VU-meter with 10 sections  
External power supply  
Dimensions: 178 x 270 x 85 mm  
Weight: 1.9 Kg



### CLUB7-usb

DJ Mixer, 13 inputs over 7 channels [3 microphones, 5 line, 2 phono or 2 USB, 1 auxiliary]

Code : B00125



#### Inputs

- 2 USB ports on channels 2 and 3 allowing playback and recording of audio files
- 3 microphones with Talkover
- 5 lines,
- 2 phono or 2 USB,
- 1 auxiliary or Player

Integrated USB/SD reader for mp3, WAV or WMA files

#### Adjustments

- 3-band equaliser on each channel
- Gain adjustment for each channel
- Talkover level adjustment

#### Outputs

- Balanced Master
- Separate Booth and Record
- 2 USB ports

LED VU-meters for channels 1-4  
Power supply: AC 230V ~ 50Hz  
Dimensions: 483 x 222 x 78 mm  
Weight: 4.5 Kg



### KM 4.1

Echo unit combined with a small mixer, perfect for karaoke.

Code : B00289



#### Inputs

- 2 mic with Talkover on back
- 2 line

#### Adjustments

- General 3-band equaliser
- Level adjustment for each input
- General level adjustment
- Echo chamber adjustment (delay, repeat, echo)

#### Output

- Unbalanced mix output

Power supply: AC 230V ~ 50Hz  
Dimensions: 483 x 44 x 180 mm  
Weight: 2 Kg

# MIDI CONTROLLERS

## TAKE CONTROL:

Hard drives and USB drives, DJ software, external CD or vinyl player.

The DJinn Pro is placed at the centre of your sound booth and of your sound booth and removes the boundaries of mixing. Without a computer, it is a USB hard drive reader with synchronised effects, advanced looping system and HotCue, offering total control over your music files. Once connected, the MIDI controller function is added, compatible with most software on the market, and provided with Virtual DJ LE. Forward-thinking and well thought-out, you can even plug your analogue sources and benefit from a full mixing desk.



**DJinnPro**  
Mixer / USB player/ Professional MIDI controller provided with Virtual DJ LE

Code : H9932



**Reader**  
2 USB readers  
4 effects that can be synchronised with the tempo, 4 Hot Cue presets  
Advanced looping system  
Total control with touch-sensitive rotary plates  
Variable pitch with Master Tone

**Controller**  
MIDI-compatible DJ software controller (MacOS and Windows)  
All keys compatible with MIDI (readers and mixer)  
Low-latency USB MIDI/Audio system  
Latest version of VirtualDJ LE included

**Mixer**  
Complete digital/analogue mixing desk  
ASIO multitrack sound card with balanced output  
2-channel mixer with source selection

(PC, Line or Phono)  
Two mic inputs with MIC OVER  
Two outputs with separate levels (Master and Booth)  
Headphone output with volume and Cue Mix adjustment  
Double LED VU-meter with Cue or Master function  
Large screen with VFD display  
Mp3 file search system in tree structure

Power supply: AC 100-240V-60/50Hz  
Dimensions: 420 x 298.8 x 89 mm  
19-inch rack [EQ-DJinn bracket optional]  
Weight: 4.42 Kg

Can be used on up-to-date computer with Windows® XP/Vista/7/8/10 or Mac® OSX

## ADD DJAZZ TO YOUR MIX

DJazz Pro is a complete DJ controller allowing you to mix music on your Mac or PC by playing loops, samples, effects, etc. Versatile, easy to use and with unlimited possibilities, DJazz offers the best in DJ controllers, whether you are a beginner or professional.

Compatible with all the major software, its universal consumer or professional connectivity, its complete and fully-integrated software deliver a tool software make it a tool really focused on the pleasure of playing music.



**DJazz Pro**  
Professional DJ MIDI control surface with multi-channel ASIO sound card

Code : H9923



DJ software controller compatible with MIDI (Mac OS X and Windows)  
- Native MIDI compatibility (driverless)  
- Standard MIDI USB input/output

Complete digital audio interface  
- Compatible with Windows (WDM) without driver  
- Compatible with Windows via ASIO driver (multitrack)  
- Compatible with MacOSX (Core Audio) without driver  
- Dedicated ASIO driver included  
- 1 line/phono stereo input through RCA compatible with CD/Vinyl Timecode  
- 1 line/phono stereo input through RCA with input gain management and Thru mode, compatible with CD/Vinyl Timecode  
- 1 aux stereo input through mini-jack with input gain management and Thru mode

- 1 mic input through 6.35 jack  
- Headphone with Cue/Mix  
- Balanced output through 6.35 jack  
- Unbalanced output through RCA  
- REC output through USB port

- A/D Conversion: 24-bit – 96kHz  
- Sampling rate: 16-bit 44.1/48kHz

Other specifications  
- Power supply: USB 5V 500mA  
- Optional external power supply: 6V 2.0A  
- Dimensions: 410 x 297 x 65 mm  
- Weight: 2.9 kg

Provided with Virtual DJ LE, ASIO driver, and mapping for Virtual DJ Pro and Traktor Pro  
Can be used on up-to-date computer with Windows® XP/Vista/7/8/10 or Mac® OSX



### DJ-KONTROL 4

Professional 4-channel MIDI controller for DJ

Code : B00385



Windows  
macOS



**Controller**  
MIDI-compatible DJ software controller (MacOS and Windows)  
Thanks to the MIDI communication protocol, this controller can be used with any other MIDI DJ software.  
8 large touch-sensitive buttons for cues, loops, samples, slices and effect adjustment.  
Scratching jog wheel with coloured backlight.  
Latest version of VirtualDJ LE included

**Mixer:**  
3-band equaliser with additional filter adjustment button.  
Microphone input.  
Headphone output with PFL/MIX  
XLR and RCA master outputs  
RCA monitor output  
RCA record output  
2 stereo RCA line inputs

A/D Conversion: 24-bit

LED VU-meter  
Power supply: USB 5V 500mA or 5V 1A external power supply  
Dimensions: 533 x 280 x 70 mm  
Weight: 2 kg

Can be used on up-to-date computer with Windows® XP/Vista/7/8/10 or Mac® OSX



### DJ-KONTROL 3S

Professional MIDI controller for DJs (travelling DJ, clubs, studios, etc.).

Code : B00384



Windows  
macOS



**Controller**  
MIDI-compatible DJ software controller (MacOS and Windows)  
Thanks to the MIDI communication protocol, this controller can be used with any MIDI software for DJs.  
Most buttons are backlit: easy to use in the dark.  
Touch-sensitive scratching jog wheels with blue backlight

Provided with the latest version of VirtualDJ LE  
**Mixer:**  
3-band equaliser with push-kill button  
DJ mic input  
PFL headphone output  
Crossfader curve adjustment. XLR and RCA master outputs

Integrated 24-bit/192kHz sound card

LED VU-meter  
Power supply: USB 5V 500mA  
Dimensions: 320 x 240 x 65 mm  
Weight: 1.4 kg

Can be used on up-to-date computer with Windows® XP/Vista/7/8/10 or Mac® OSX



### EQ-DJinn

19" brackets for DJinn and DJinnPro

Code : H9856



### Brackets for DJ-KONTROL 3

19" brackets for DJ-KONTROL 3 and 3S.

Code : B00392



Material: steel  
Finish: black lacquer

19" brackets for DJ-KONTROL 3 and 3S.



# CD PLAYERS



Adjustable automatic and manual loops, effects synchronised to tempo, HotCue, Samples and and Scratch are just some examples of its capacity.

Capable of reading mp3 CDs, and USB supports (keys or hard drives), it transforms into a controller that can be used with most DJ software, and allows you to play using all supports.

**CDX6**  
CD/USB mass storage player and MIDI controller

Code : H9574

Windows  
macOS

CD MP3 slot in reader  
USB reader on two ports for keys or external hard drive.  
MIDI controller via USB on back

DSP with Echo, Flanger, Filter, Reverse and Scratch effects.  
Touch sensitive panel with illuminated ring for control  
3 Jog modes: Vinyl, BEND and A.Cue scratch

Adjustable pitch with Master Tempo  
4 HOT CUE points  
4 samples in memory  
Synchronisation of effects with tempo  
Adjustable smart loop  
Auto or manual BPM



Next track reserve to choose next track to be played  
USB link to connect two players to a shared hard drive

Large screen with VFD display  
ID3Tag visualisation of artists, titles and genres  
Tree structure mp3 file search system.

Xstart for cue start with crossfader on equipped mixers

Dimensions: 296 x 218 x 104 mm  
Weight: 2.4kg

Can be used on up-to-date computer with Windows® XP/Vista/7/8/10 or Mac® OSX

**CDX4**  
USB and CD mp3 player with effects and SMART LOOP

Code : H9812

CD MP3 slot in reader  
USB mass storage player for USB drive or hard drive

DSP with Scratch, Flanger, Filter, Echo, Reverse effects with adjustable level and settings.  
Multifunction touch-sensitive rotary table

Adjustable pitch with Master Tone  
SMART LOOP: Loop with adjustable length according to tempo  
Auto loop with adjustable length according to tempo  
AVM: Anti Vibration Memory  
Auto-Cue and track order programming

Highly readable blue LCD display  
ID3Tag visualisation of artists, titles and genres  
Tree structure mp3 file search system.

Analogue and digital output  
Xstart and Relay connections

Dimensions: 220 x 315 x 100 mm  
Weight: 2.5 kg





CD/USB/SD players. Rack-mountable CD, USB or SD players for live applications in sound booth, with DJ, theatre, or entertainment-oriented functions, you will certainly find a model that suits your needs among our players.



**USB 2.2 Mk2**  
Double CD player with two USB ports

---

Code : B00363

---



Double CD player, Mp3, Wave and CDA USB player with double USB mass-storage input (on front and back)

Jog wheel with two modes: Vinyl and pitch bend  
Advanced random playback functions  
Adjustable pitch with Master Tempo  
Auto and manual BPM, perfect loop (IN/OUT/RELOOP)  
AVM: Anti Vibration Memory  
Auto CUE

Alphanumerical LCD screen allows reading ID3V2 tags (track title, artist and sampling rate).  
Tree structure mp3 file search system.

Xstart for cue start with crossfader on equipped mixers

Player dimensions 482 x 89 x 267mm  
Remote dimensions 482 x 89 x 94 mm  
Weight: 4.6kg (player) 1.7kg (remote)



**USB 1.1 REC**  
CD/USB player + recorder

---

Code : B00365

---



CD Mp3, Wave and CDA player USB player with double USB mass-storage input (on front and back)

Lossless recording from an external source in WAV or MP3 files (bitrate: 64, 128, 192, 256 and 320kbit/s), even during playback of CD tracks or USB devices.  
Auto or manual recording processor: for a simple recording process without distortion

Variable pitch with Master Tone  
Auto and manual BPM, perfect loop (IN/OUT/RELOOP)  
AVM: Anti Vibration Memory  
Auto CUE

Large screen with VFD display  
ID3Tag visualisation of artists, titles and genres  
Tree structure mp3 file search system.

Infrared remote control included for playback, recording, looping, search, pitch, and volume functions.

Right/left output through XLR and RCA

Dimensions: 482 x 89 x 270 mm  
Weight: 4.35 kg



**MPu320**  
Double CD player with two USB mass-storage ports and touch-sensitive jog wheels

---

Code : H9681

---



Double CD player, Mp3, Wave and CDA USB player with double USB mass-storage input (on front and back)

Jog wheel with two modes: Jog scratch and pitch bend  
Variable pitch with Master Tone  
Auto and manual BPM, perfect loop (IN/OUT/RELOOP)  
AVM: Anti Vibration Memory  
Auto CUE

Large screen with VFD display  
ID3Tag visualisation of artists, titles and genres  
Tree structure mp3 file search system.

Xstart for cue start with crossfader on equipped mixers, Relay for continuous playback

Player dimensions 482 x 89 x 263 mm  
Remote dimensions 482 x 91 x 94 mm  
Weight: 5.1kg (player) 1.9kg (remote)



**MPu310**  
Mp3-compatible CD/USB player with infrared remote and XLR/RCA output

---

Code : H9680

---



CD Mp3, Wave and CDA player USB player with double USB mass-storage input (on front and back)

Variable pitch with Master Tone  
Auto and manual BPM, perfect loop (IN/OUT/RELOOP)  
AVM: Anti Vibration Memory  
Auto CUE

Large screen with VFD display  
ID3Tag visualisation of artists, titles and genres  
Tree structure mp3 file search system.

Infrared remote control included for playback, recording, looping, search, pitch, and volume functions.

Right/left output through XLR and RCA

Dimensions: 482 x 89 x 270 mm  
Weight: 5.1 kg



# VINYL TURNTABLES

Back to the source. Listen to your favourite albums on high-quality vinyl, protect your collection with easy-to-use solutions offering unmatched sound quality thanks to our vinyl-dedicated range of products.



## XTRM-1

Direct Super High torque motor + line out

Code : B00322



Direct Drive 3-phase Super High Torque motor with extreme torque of 4.5kg/cm  
Adjustable start and stop time from 0.2 to 6 seconds  
3 speeds: 33, 45, 78 rpm with quartz lock and optical sensors  
Pitch at  $\pm 10\%$   $\pm 20\%$   $\pm 50\%$   
Standard or reverse playback  
2 Start/Stop buttons  
White LED lighting on cartridge  
Phono or Line output on back  
High-quality S-shaped metal tonearm with adjustable height.  
Special anti-resonant frame  
Tall adjustable support legs  
Dimensions: 450 x 353 x 86 mm  
Weight: 12 kg  
Comes with cartridge holder, felt mat and 45 rpm adapter



## Q3usb

USB direct motor + line output

Code : B00353



Direct Drive 3-phase High Torque motor with torque higher than 1.6kg/cm  
Quick start/stop  
3 speeds: 33, 45, 78 rpm with quartz lock  
Pitch at  $\pm 10\%$   $\pm 20\%$   
Standard or reverse playback  
White lighting on cartridge  
Phono or Line output on back  
High-quality S-shaped metal tonearm with adjustable height.  
Adjustable support legs to level the turntable  
Dimensions: 450 x 352 x 157 mm  
Weight: 10.5 kg

USB output for direct recording onto any computer using Audacity software, which can be downloaded for free, so as to:  
change the speed and key, reduce noise, equalise, import and export files, etc.

Comes with dust cover, Audio Technica cartridge, USB cable, felt mat, 45 rpm adapter



## Q1usb

Belt drive  
USB + line output

Code : B00352



Belt-drive motor Quick start/stop  
2 speeds: 33, 45 rpm  
Pitch at  $\pm 10\%$   
Phono or Line output on back  
Retractable white lighting on cartridge  
S-shaped metal tonearm assembled with:  
- Counterweight- Anti-skating control - Arm lever  
Adjustable support legs to level the turntable  
Dimensions: 450 x 350 x 150 mm  
Weight: 9.0 kg

USB output for direct recording onto any computer using Audacity software, which can be downloaded for free, so as to:  
change the speed and key, reduce noise, equalise, import and export files, etc.

Comes with dust cover, Audio Technica cartridge, USB cable, felt mat, 45 rpm adapter



## S-15

AUDIOTECNICA cartridge complete with needle

Code : H4369



Spherical type  
Frequency: 20 to 20,000Hz  
3 to 4g tracking force



## STYLUS-15

Replacement needle for S-15

Code : H4371



Spherical type  
Frequency: 20 to 20,000Hz  
3 to 4g tracking force



## HEADSHELL-NO

Black metal cartridge holder

Code : H4373



Fits all turntables and most cartridges on the market.



## TT-CASE

High-quality modern flight-case for DJ turntables (T2, T3, X-TRM1, SL1200, etc.).

Code : B03206

High-quality modern flight-case for DJ turntables (T2, T3, X-TRM1, SL1200, ...).  
2 butterfly latches, solid handle, interior finish in shock-absorbing foam rubber

**NEW**

## ATN3600L

Audio Technica AT3600 & AT3600L replacement needle  
Code: B08200

## AT91/BL

Hi-Fi Audio Technica AT91BL cartridge  
Code: B08201

## AT91

Audio-Technica ATN91 replacement needle  
Code: B08202

# MICROPHONES



Hear the difference with the range of microphones and HF systems from Audiophony® and JBsystems®. These models are amongst the greatest references of the audio world, constantly striving for better performance and ergonomics in the service of sound professionals.



**RP1**  
Dynamic cardioid microphone for voice

---

Code : H9654

---



Use: Vocals  
Type: Dynamic cardioid  
Finish: Moulded aluminium body, reinforced anti-shock grill and pop filter  
Connection: XLR  
Impedance: 600Ω +/-30% @ 1kHz  
Frequency response: 70Hz - 16kHz  
Sensitivity: -53dB +/-3dB  
Weight: 360 g  
Dimensions: 180 x 53mm



**RS1**  
Dynamic microphone for voice

---

Code : H9653

---



Use: Vocals  
Type: Dynamic cardioid  
Finish: Moulded aluminium body, reinforced anti-shock grill and pop filter  
Connection: XLR  
Impedance: 600Ω +/-30% @ 1kHz  
Frequency response: 40Hz - 16kHz  
Sensitivity: -52dB +/-3dB  
Weight: 355 g  
Dimensions: 185 x 50 mm



**JB27**  
Professional microphone

---

Code : B00410

---



Use: Vocals  
Type: Dynamic cardioid  
Finish: Moulded aluminium body, reinforced anti-shock grill and pop filter with ON/OFF  
Connection: XLR  
Impedance: 250Ω  
Frequency response: 50Hz - 18kHz  
Sensitivity: -72dB  
Comes with case, clamp and 6m XLR to mono jack cable



**JB10**  
Professional dynamic microphone

---

Code : B00402

---



Use: Dynamic microphone for entertainment and speech  
Type: Dynamic cardioid  
Finish: Metal body and solid build with ON/OFF button  
Connection: XLR  
Impedance: 500 Ω  
Frequency response: 70Hz - 14kHz  
Sensitivity: -75dB  
Comes with case, clamp and 6m XLR to mono jack cable



**DMC62**  
Dynamic microphone for entertainment and speech

---

Code : H9652

---



Use: Dynamic microphone for entertainment and speech  
Type: Dynamic cardioid  
Finish: Metal body and solid build with ON/OFF button  
Connection: XLR  
Impedance: 500 Ω  
Frequency response: 80Hz - 15kHz  
Sensitivity: -54dB  
Comes with case, clamp and 6m XLR to mono jack cable



**JB5**  
Semi-professional dynamic microphone for DJ, voice or music

---

Code : B00408

---



Use: Dynamic microphone for entertainment and speech  
Type: Dynamic cardioid  
Finish: Metal body and solid build with ON/OFF button  
Connection: moulded cable with jack connector  
Impedance: 600 Ω  
Frequency response: 100Hz - 12kHz  
Sensitivity: -74dB  
Comes with 2m mono jack cable



**JB30**  
Gooseneck microphone

---

Code : B00411

---



Use: Dynamic gooseneck microphone for speech  
Type: Unidirectional microphone  
Finish: 30cm metal gooseneck with ON/OFF button  
Connection: XLR  
Impedance: 500 Ω  
Frequency response: 80Hz - 14kHz  
Sensitivity: -74dB



**JB33**  
Suitable for conferences, etc.

---

Code : B00406

---



Use: Conference gooseneck microphone  
Type: Condenser Electret 1.5V  
Finish: 23cm metal gooseneck with ON/Standby/OFF button  
Connection: 3.5 and 6.35 jack  
Impedance: 1000 Ω  
Frequency response: 70Hz - 16kHz  
Sensitivity: -66dB

# MICROPHONES



## PACK-UHF410-Head

Code : H10283



Pack including:  
 1 UHF410-Base receiver  
 1 UHF410-Body waistband transmitter  
 1 UHF410-Head headset microphone  
 1 carrying case



## PACK-UHF410-Lava

Code : H10284



Pack including:  
 1 UHF410-Base receiver  
 1 UHF410-Body waistband transmitter  
 1 UHF410-Lava lavalier microphone  
 1 carrying case



## PACK-UHF410-Hand

Code : H10282



Pack including:  
 1 UHF410-Base receiver  
 1 UHF410-Hand handheld microphone  
 1 carrying case



## UHF410-Base

UHF true diversity receiver with auto scan and sync function

Code : H10271



True Diversity receiver  
**New frequency ranges UHF 823 ~ 832 and 863 ~ 865 MHz, 4G compatible**  
 Programmed frequencies with auto-scan function  
 Presets for 4 groups, 4 channels  
 LCD display: frequency, group, channel, RF & AF  
 Balanced and unbalanced audio output through XLR and 6.35 mono jack  
 Line or Mic level  
 Volume level adjusted through rotary switch on front  
 Detachable BNC antennae, multiple accessories available  
 Power supply: 12V DC (adapter provided)  
 Dimensions: 200 x 42 x 183mm (rack-mountable 19 inch by two)



## UHF410-Hand

Condenser handheld microphone transmitter

Code : H10272



Handheld electret condenser microphone  
 True Diversity transmitter  
**New frequency ranges UHF 823 ~ 832 and 863 ~ 865 MHz, 4G compatible**  
 Output power: 10mW (max.)  
 40 programmed frequencies with SYNC function  
 LCD display: channel, battery level  
 Power supply: 2 AA 1.5V batteries (not included)  
 Average battery life: 10 hours  
 Dimensions: 260 x 54mm diameter



## UHF410-Body

UHF diversity waistband transmitters

Code : H10273



True Diversity Transmitter  
**New frequency ranges UHF 823 ~ 832 and 863 ~ 865 MHz, 4G compatible**  
 Output power: 10mW (max.)  
 40 channels with auto-scan function  
 LCD display: channel, battery level  
 Mic input through mini XLR  
 Gain level -10/0/+10dB  
 Power supply: 2x AA type 1.5V batteries (not included)  
 Battery life: 10 hours on average  
 Dimensions: 98 x 65 x 25mm (+ 75mm for antenna)



## UHF410-Head

Sweatproof headset microphone

Code : H10274



Sweatproof headset electret condenser microphone, ideal for sport clubs  
 Sensitivity: -47 ±4dB  
 Polarity: Unidirectional cardioid  
 Frequency response: 100Hz - 10KHz  
 Operating voltage: 1.5V  
 Power consumption: 0.5mA max.  
 Signal to noise ratio: Higher than 60dB  
 Accessories included: Windscreen  
 Connectivity: Mini XLR



## UHF410-Lava

Discrete lavalier condenser microphone

Code : H10275



Miniature lavalier electret condenser microphone  
 Sensitivity: -47 ±4dB  
 Polarity: Omnidirectional cardioid  
 Frequency response: 50Hz - 10KHz  
 Operating voltage: 1.5V  
 Power consumption: 0.5mA max.  
 Signal to noise ratio: Higher than 58dB  
 Accessories included: Windscreen and fastening pin  
 Connectivity: Mini XLR  
 Dimensions: 37 x 5.5mm diameter



**UHF-410-Boost**  
Booster antenna with BNC connector

Code : H10276



Gain from 9 dB +/-1dB  
Frequency range: 550-950MHz  
Operating voltage: 8V  
Impedance 50Ω



**UHF410-Hold**  
Antenna support with BNC connector

Code : H10277



5/8" threading for microphone stand and male/male BNC connector



**UHF410-Split**  
2-in-1 Splitter IN/OUT with BNC connector

Code : H10278



Frequency range: 400 ~ 1000MHz  
Stationary wave report (VSWR): < 2  
Input impedance: 50 Ω  
Isolation: 18dB  
Loss: < 3dB  
Connectors: BNC  
Dimensions: 77 x 64 x 26 mm



**UHF410-Ant**  
Long range directional antenna with BNC connector

Code : H10279



Frequency range: 500 ~ 950 MHz  
Beam width:  
80° E-plane, 140° H-plane  
Impedance: 50 Ω  
Connector: BNC  
Dimensions: 295 x 210 x 31 mm



**UHF410-Rall1m**  
BNC/BNC 1 metre antenna extension cable

Code : H10280



**UHF410-Rall10m**  
BNC/BNC 10 metre antenna extension cable

Code : H10281



**UHF410-BNC2**  
BNC/BNC connector for bracket

Code : H10639



**UHF410-Rack**  
Long bracket for receiver

Code : H10640



**UHF410-BNC1**  
BNC/BNC connector for extension

Code : H10641



The UHF410 range benefits from the latest technological developments for an optimal transmission quality.

This range meets European requirements and uses the frequency ranges 823 ~ 832 and 863 ~ 865 MHz, that are compatible with 4G.



# MICROPHONES



## GO-Lava pack

Code : H10000



Pack including:  
1 GO-MONO receiver  
1 GO-MONO waist transmitter  
1 GO-Lava lavalier mic



## GO-Head pack

Code : H10001



Pack including:  
1 GO-MONO receiver  
1 GO-Body waist transmitter  
1 GO-Head headset microphone



## GO-Hand pack

Code : H9999



Pack including:  
1 GO-MONO receiver  
1 GO-Hand handheld microphone



## GO-Mono

UHF diversity receiver, 16 frequencies for 1 transmitter

Code : H9988



UHF 16-frequency receiver  
**New frequency ranges UHF 823 ~ 832 and 863 ~ 865 MHz, 4G compatible**  
Diversity system for reception free of micro-cuts.  
Adjustable squelch for parasite absorption  
Simultaneous operation of 4 receivers (4 mics)  
Adjustable antennae on front  
Average range 70m in ideal conditions  
Balanced XLR and unbalanced jack outputs  
Rack-mountable by two via FREE-RACK (optional)  
Dimensions: 130 x 36 x 92 mm

The UHF GO range benefits from the latest technological developments for an optimal transmission quality.

Equipped with entirely redesigned electronics, the transmitters and receivers now allow using 4 microphones simultaneously with an optimal reception quality.

Easy to use, the GO Mono transmitter allows receiving from a Diversity transmitter, with a choice of 16 frequencies.

- Compatible with the new TNT and 4G frequencies
- Up to 4 mics simultaneously
- Balanced and unbalanced output
- Implies the use of 4 transmitters and 4 receivers in the GO range





### GOHand

UHF transmitter handheld condenser microphone

Code : H9989



Handheld microphone only  
Must be paired with a GO-MONO receiver  
**New frequency ranges UHF 823 – 832 and 863 – 865 MHz, 4G compatible**  
High-end Electret condenser capsule  
Distortion rate lower than 1% @ 1kHz  
Works with AA-type 1.5V batteries  
Dimensions: 237 x 58 mm



### GOBody

Waist transmitter housing for lavalier or headset microphone

Code : H9990



Pocket UHF transmitter 16 frequencies  
**New frequency ranges UHF 823 – 832 and 863 – 865 MHz, 4G compatible**  
Mini XLR connector  
Adjustable impedance on either Line or Mic position  
Works with AA-type 1.5V batteries  
Dimensions: 65 x 100 x 27 mm



### GOHead

Mini XLR condenser headset microphone

Code : H9991



Headset microphone only  
Must be paired with a GO-BODY transmitter and a GO-MONO receiver.  
Mini XLR connector  
Comes with windscreen and adjustable headband  
Unidirectional condenser capsule  
Frequency response: 100Hz to 16kHz  
S/N: > 60dB  
Impedance: 2.2 kOhms

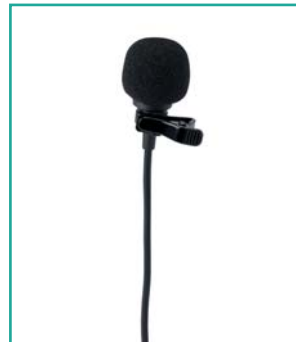

### GOLava

Mini XLR condenser lavalier microphone

Code : H9992



Lavalier microphone only  
Must be paired with a GO-BODY transmitter and a GO-MONO receiver.  
Mini XLR connector  
Comes with windscreen and clamp  
Unidirectional condenser capsule  
Frequency response: 100Hz to 16kHz  
S/N: > 60dB  
Impedance: 2.2 kOhms



### BODYPOCKET

Neoprene waistband for UHF-BODY transmitter

Code : H10484



Compatible with most transmitters on the market  
Ideal for sports clubs



### MICRO CASE 3U

Rack 19" 3U 230mm/300mm

Code : B03221



Flight case for 19-inch HF microphone receiver.  
Depth 230mm (300mm with cover)



### FREE-RACK

19 inch rack bracket for 2 GO receivers

Code : H9374



Material: Steel  
Finish: Black paint



# MICROPHONES



## WMS-10

UHF wireless microphone system comprising WMIC-10 handheld microphone and receiver.

Code : B00438



UHF wireless microphone system comprising WMIC-10 handheld microphone and 16-frequency UHF receiver.  
 Frequency range: 863 – 865 MHz  
 Diversity system for reception free of micro-cuts.  
 Adjustable squelch for parasite absorption  
 Simultaneous operation of 4 receivers (4 mics)  
 Adjustable antennae on front  
 Balanced XLR and unbalanced jack outputs  
 Rack-mountable by two via RP-WMIC 19" (optional)  
 UHF handheld microphone with 16 frequencies  
 Dynamic unidirectional capsule  
 Distortion rate lower than 1% @ 1kHz  
 Works with AA-type 1.5V batteries



## WBS-20

UHF wireless microphone system comprising WBP-20 waistband housing, lavalier microphone and receiver.

Code : B00439



UHF wireless microphone system comprising WBP-20 waistband housing, lavalier microphone and 16-frequency UHF receiver.  
 Frequency range: 863 – 865 MHz  
 Diversity system for reception free of micro-cuts.  
 Adjustable squelch for parasite absorption  
 Simultaneous operation of 4 receivers (4 mics)  
 Adjustable antennae on front  
 Balanced XLR and unbalanced jack outputs  
 Rack-mountable by two via RP-WMIC 19" (optional)  
 UHF waistband housing with 16 frequencies  
 Mini XLR connector  
 Adjustable impedance on either Line or Mic position  
 Works with AA-type 1.5V batteries  
 Distortion rate lower than 1% @ 1kHz  
 Unidirectional Electret capsule lavalier microphone



## WBP-20

Optional waistband housing.

Code : B00441



UHF waistband housing with 16 frequencies  
 Mini XLR connector  
 Adjustable impedance on either Line or Mic position  
 Works with AA-type 1.5V batteries  
 Distortion rate lower than 1% @ 1kHz



## WMIC-10

UHF receiver handheld microphone

Code : B00440



UHF handheld microphone with 16 frequencies  
 Dynamic unidirectional capsule  
 Distortion rate lower than 1% @ 1kHz  
 Works with AA-type 1.5V batteries



## WHS-20

Mini XLR condenser headset microphone

Code : B00442



Headset microphone for musicians, teachers and fitness clubs  
 Must be paired with a WBP-20 transmitter  
 Mini XLR connector  
 Comes with windscreen and adjustable headband  
 Unidirectional condenser capsule  
 Frequency response: 100Hz to 16kHz  
 S/N: > 60dB  
 Impedance: 2.2 kOhms



## RP-WMIC

19" adapter for 1 or 2 receivers (WMS-1 or WBS-2 set).

Code : B00437



19" adapter for 1 or 2 receivers (WMS-1 or WBS-2 set).



The Wave was designed to provide high-fidelity vocal reproduction. Ideal for events and presentations, you can count on its battery life and long range for a VHF microphone. Its dynamic capsule perfectly preserves the timbre and intonation of your voice.

VHF receiver with handheld microphone. 2 available frequencies: VHF 177.5MHz and 185.3MHz for simultaneous use of two microphones.

- **Compatible with TNT and 4G frequencies**
- **Battery life of almost 8 hours**
- **Dynamic handheld microphone**
- **Range up to 50m**



**WAVE-F1**  
VHF receiver with handheld microphone.

---

Code : H9549

---



Carrier frequency:  
- 177.5MHz for WAVE-F1

- Receiver:
- Output level adjustment to avoid signal saturation.
  - Unbalanced 6.35 jack output (jack/jack cord provided)
  - AC adapter power supply included: DC 9V 300mA

- Transmitter microphone:
- Dynamic cardioid capsule handheld microphone.
  - Plastic body and reinforced metal grill.
  - OFF/Mute/ON switch
  - Pop filter.
  - Frequency response: 40 to 13kHz
  - Signal to noise ratio: 80 dB
  - Range: up to 50m on average with no dead zone
  - 9V (6LR-61) battery powered (included)



**WAVE-F2**  
VHF receiver with handheld microphone.

---

Code : H9550

---



Carrier frequency:  
- 185.3MHz

Other features identical to WAVE-F1

# AUDIO HEADPHONES



## YC100

Closed wired headphones Comfortable on all levels

Code : H10129



Transducer type: Dynamic  
 Driver diameter: 50mm  
 Impedance: 60 Ω  
 Sensitivity: 100dB +/-3dB  
 Power handling: 1000mW  
 Frequency response: 10Hz - 20kHz  
 Cable: 4mm x 2.2m  
 Connectivity: 3.5mm with 6.35mm adapter included  
 Weight: 310 g



## HPS-2

Professional DJ headphones

Code : B00508



Transducer type: Dynamic  
 Driver diameter: 50mm  
 Impedance: 29 Ω  
 Sensitivity: 101 dB +/-3 dB  
 Power handling: 1000mW  
 Frequency response: 15 Hz - 22 kHz  
 Cable: 3m coiled cable and smartphone cable with integrated microphone  
 Connectivity: 3.5mm with 6.35mm adapter included  
 Weight: 280 g



## DJ-950

Closed dynamic headphones with directional earpieces and bass boost. Special for DJ.

Code : H8222



Driver diameter: 57 mm  
 Impedance: 64 Ω  
 Sensitivity: 113 dB  
 Maximum power: 3.5W  
 Frequency response: 5 - 30kHz  
 Cable: 4m with 3.5/6.35 jack adapter and right-angled 6.35  
 Carrying case and replacement ear pads included



## HP2000 PRO

Professional high-performance earphones for DJ.

Code : B00505



Driver diameter: 57 mm  
 Impedance: 64 Ω  
 Sensitivity: 107 dB  
 Maximum power: 3500 mW  
 Frequency response: 5 - 30kHz  
 Cable: 3m coiled cable with 3.5/6.35 jack adapter and right-angled 6.35  
 Carrying case and replacement ear pads included  
 Weight: 290 g



## HP1500 PRO

Stereo DJ earphones.

Code : B00507



Driver diameter: 57 mm  
 Impedance: 32 Ω  
 Sensitivity: 108 dB  
 Maximum power: 3500 mW  
 Frequency response: 20 - 20 kHz  
 Cable: 3m coiled cable with 3.5/6.35 right-angled jack adapter  
 Carrying case  
 Weight: 160 g



## DJ-930

Dynamic semi-closed headphones with directional earpieces

Code : H8223



Driver diameter: 57 mm  
 Impedance: 64 Ω  
 Sensitivity: 107 dB  
 Maximum power: 3.5W  
 Frequency response: 30 - 18 kHz  
 Cable: 4m with 3.5/6.35 jack adapter  
 Carrying case included



### HeadZ Fuchsia

The best of light earphones + mic with outstanding sound quality for your smartphone, tablet, laptop, etc.

Code : B00512



### HeadZ White

The best of light earphones + mic with outstanding sound quality for your smartphone, tablet, laptop, etc.

Code : B00513



### YBT-100G

High-fidelity Bluetooth stereo headphones  
Comes with carrying case

Code : H10303



### YBT-100S

High-fidelity Bluetooth stereo headphones  
Comes with carrying case

Code : H10304



Headphones for smartphone, tablet or laptop  
Driver diameter: 38 mm  
Impedance: 64 Ω  
Sensitivity: 98 dB  
Frequency response: 10 - 20 kHz  
Cable: with integrated microphone and computer adapter  
Weight: 160 g

Fuschia pink colour

Headphones for smartphone, tablet or laptop  
Driver diameter: 38 mm  
Impedance: 64 Ω  
Sensitivity: 98 dB  
Frequency response: 10 - 20 kHz  
Cable: with integrated microphone and computer adapter  
Weight: 160 g

White colour

Compatible with all Bluetooth® devices  
Bluetooth® 4.0 Class 2  
Supported Bluetooth protocols: V4.0 CSR HFP, A2DP, AVRCP, vocal aids  
Communication distance: Up to 10 meters -  
Average battery life: 8 hours music playback  
IPX5 (sweat and rain resistant)  
Battery: Lithium 85mAh  
Output level: 100dB max.  
Frequency response: 20Hz-20KHz  
Signal to noise ratio: >70dB  
Distortion: <0.1%  
Weight: 14 g

Comes with protection box, charging cable, ear-fit silicon tips

## ALWAYS BY YOUR SIDE

Our range of headphones covers all areas: Street, Studio, DJing or Audiophile. Whether you choose Bluetooth® or other headphones, sound excellence, fit and design remain the main focus of our creations. Our models are amongst the greatest references of the audio world, serving individuals and professionals alike.







# PORTABLE SOUND SYSTEMS

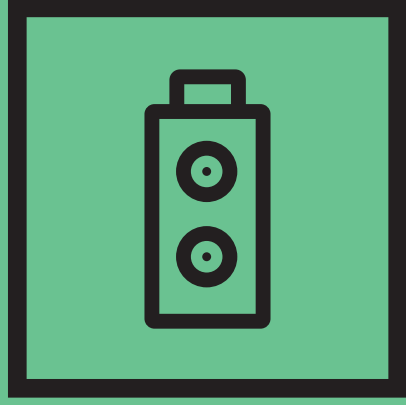

# PORTABLE SOUND SYSTEMS

Ultra mobility à la carte. Get out and about, and take your sound system with you wherever you go. From ultra-portable to ultra-powerful, from basic units to comprehensive sound systems, our extensive range covers all uses.

**NEW**



**CR25A-COMBO**  
Battery-powered portable sound system, 250 W RMS with BT, USB reader and two UHF microphones

Code : H10789



Power rating: 250 W (2 channels)  
Loudspeaker: 12" loudspeaker + 1.35" driver  
Microphones supplied : Two hand-held UHF microphones, 16 selectable frequencies  
**New 4G-compatible frequency ranges: UHF 823 to 832 MHz and 863 to 865 MHz**  
Free UHF microphone slot: No  
Source: USB/SD reader + Bluetooth®  
Free music player slot: No  
Inputs: Two LINE inputs on 3.5 mm stereo jack or RCA, two MIC/LINE inputs on combined XLR/Jack  
Echo chamber with adjustable delay  
Outputs: One LINE level on 6.35 mm TRS jack  
Battery: 2 x 18 V / 7 Ah NP  
Battery life: 5 hours (average)  
Weight: 24.5 kg  
Dimensions: 615 x 350 x 395mm  
Accessories supplied: Built-in trolley, infrared remote control

Options:  
COV-CR25A (protective cover)  
CR12A-HEADSET (pocket UHF transmitter and headset microphone)



**CR12A-COMBO**  
Battery-powered portable sound system, 120 W RMS with BT, USB reader and two UHF microphones

Code : H10209



Power rating: 120 W (2 channels)  
Loudspeaker: 10" loudspeaker + 1" driver  
Microphones supplied : Two hand-held UHF microphones, 16 selectable frequencies  
**New 4G-compatible frequency ranges: UHF 823 to 832 MHz and 863 to 865 MHz**  
Free UHF microphone slot: No  
Source: USB/SD reader + Bluetooth®  
Free music player slot: No  
Inputs: Two LINE inputs on 3.5 mm stereo jack or RCA, two MIC/LINE inputs on combined XLR/Jack  
Outputs: One LINE level on 6.35 mm TRS jack  
Battery: 2 x 12 V / 5 Ah NP  
Battery life: 6 hours (average)  
Weight: 17.3 kg  
Dimensions: 550 x 340 x 300 mm  
Accessories supplied: Built-in trolley, infrared remote control

Options:  
COV-CR12A (protective cover)  
CR12A-HEADSET (pocket UHF transmitter and headset microphone)



**CR120A-U1**  
Portable sound system, 120 W with BT, USB reader and one UHF microphone; supplied without battery

Code : H10285



Power rating: 120 W (2 channels)  
Loudspeaker: 10" loudspeaker + 1" driver  
Microphone supplied: One hand-held UHF microphone, 16 selectable frequencies  
**New 4G-compatible frequency ranges: UHF 823 to 832 MHz and 863 to 865 MHz**  
Free UHF microphone slot: No  
Source: USB/SD reader + Bluetooth®  
Free music player slot: No  
Inputs: Two LINE inputs on 3.5 mm stereo jack or RCA, two MIC/LINE inputs on combined XLR/Jack  
Outputs: One LINE level on 6.35 mm TRS jack  
Battery: 2 x 12 V / 5 Ah NP (optional)  
Battery life: 6 hours (average)  
Weight: 16 kg without battery  
Dimensions: 550 x 340 x 300 mm  
Accessories supplied: Built-in trolley, infrared remote control

Options:  
COV-CR12A (protective cover)  
CR12A-HEADSET (pocket UHF transmitter and headset microphone)  
BATTERIES (Z08118 x 2)



**CR80A-COMBO**  
Battery-powered portable sound system, 80 W with BT, USB reader and one UHF microphone

Code : H10313



Power rating: 80 W (2 channels)  
Loudspeaker: 6.5" loudspeaker + 1" driver  
Microphone supplied: 1 hand-held UHF microphone  
Fixed frequency: UHF range (863-865 MHz) - 10 mW  
Free UHF microphone slot: No  
Source: USB/SD reader + Bluetooth®  
Free music player slot: No  
Inputs: Two LINE inputs on 3.5 mm stereo jack or RCA, two MIC/LINE inputs on combined XLR/Jack  
Outputs: One LINE level on 6.35 mm TRS jack  
Battery: 2 x DC 12 V 1.5 Ah Li-ion  
Battery life: 5 hours (average)  
Weight: 5.9 kg  
Dimensions: 375 x 240 x 210 mm  
Accessories supplied: Infrared remote control

Options:  
COV-CR80A (protective cover)

**NEW**



**COV-CR25A**  
Protective cover for CR25A-COMBO

Code : H10791



**COV-CR12A**  
Case for CR12A-COMBO loudspeaker

Code : H10208



**COV-CR80A**  
Case for CR80A-COMBO loudspeaker

Code : H10431



Rear view of CR12A-COMBO loudspeaker



### SPRINTER-One-V122

Battery-powered portable sound system, 120 W, without built-in sources

Code : H9977



### SPRINTER122

Battery-powered portable sound system, 120 W with BT, MP3 CD/USB/SD reader and one UHF microphone

Code : H9837



### CROSSER180

Battery-powered portable sound system, 180 W with BT, MP3 CD/USB/SD reader and one UHF microphone

Code : H9895



### CROSSER-One-V180

Battery-powered portable sound system, 120 W, without built-in sources

Code : H9978



Power rating: 120 W (2 channels)  
Loudspeaker: 10" loudspeaker + 1" driver  
Free UHF microphone slot: 2  
Free music player slot: One CD-RUN or USB-RUN slot, one RUN-K7 slot  
Inputs: Two LINE in, two MIC in  
Outputs: One MIX out, one speaker out  
Battery: 2x 12 V / 4,5 Ah NP  
Battery life: 6 hours (average)  
Weight: 14 kg  
Dimensions: 500 x 320 x 290 mm  
Accessories supplied: Transport cover, built-in trolley, battery charger

Options: CD/USB/SD/MP3 reader + Bluetooth® + pitch and remote control, USB MP3 reader  
Additional microphone receiver, additional hand-held UHF microphone, additional headset UHF microphone, cassette module

Recommended passive loudspeaker: PASSSPRINT

Power rating: 120 W (2 channels)  
Loudspeaker: 10" loudspeaker + 1" driver  
Microphone supplied: One hand-held UHF microphone, 16 selectable frequencies  
**New 4G-compatible frequency ranges: UHF 823 to 832 MHz and 863 to 865 MHz**  
Free UHF microphone slot: 1  
Source: CD/USB/SD/MP3 reader + pitch + Bluetooth®  
Free music player slot: No  
Inputs: Two LINE in, two MIC in  
Outputs: One MIX out, one speaker out  
Battery: 2x 12 V / 4,5 Ah NP  
Battery life: 6 hours (average)  
Weight: 15 kg  
Dimensions: 500 x 320 x 290 mm  
Accessories supplied: Transport cover, built-in trolley, battery charger, infrared remote control

Options: Additional UHF receiver, additional hand-held UHF microphone, additional headset UHF microphone, cassette module

Recommended passive loudspeaker: PASSSPRINT

Power rating: 180 W (2 channels)  
Loudspeaker: 10" loudspeaker + 1.5" driver  
Microphone supplied: One hand-held UHF microphone, 16 selectable frequencies  
**New 4G-compatible frequency ranges: UHF 823 to 832 MHz and 863 to 865 MHz**  
Free UHF microphone slot: 1  
Source: CD/USB/SD/MP3 reader + pitch + Bluetooth®  
Free music player slot: No  
Inputs: Two LINE in, two MIC in  
Outputs: One MIX out, one speaker out  
Battery: 2 x 12 V / 5 Ah NP  
Battery life: 7 hours (average)  
Weight: 17 kg  
Dimensions: 500 x 320 x 360 mm  
Accessories supplied: Transport cover, built-in trolley, battery charger, infrared remote control

Options: Additional UHF receiver, additional hand-held UHF microphone, additional headset UHF microphone

Recommended passive loudspeaker: PASSCROSS

Power rating: 180 W (2 channels)  
Loudspeaker: 10" loudspeaker + 1.5" driver  
Free UHF microphone slot: 2  
Free music player slot: One CD-RUN or USB-RUN slot  
Inputs: Two LINE in, two MIC in  
Outputs: One MIX out, one speaker out  
Battery: 2 x 12 V / 5 Ah NP  
Battery life: 7 hours (average)  
Weight: 16 kg  
Dimensions: 500 x 320 x 360 mm  
Accessories supplied: Transport cover, built-in trolley, battery charger

Options: CD/USB/SD/MP3 reader + Bluetooth® + pitch and infrared remote control  
Additional microphone receiver, additional hand-held UHF microphone, headset UHF microphone

Recommended passive loudspeaker: PASSCROSS



### CR80-HEADSET

Transmitter + headset microphone for CR80A-COMBO

Code : H10534



### CR-12AHEADset

Transmitter + headset microphone for CR12A-COMBO

Code : H10210



### COV-CROSS

Transport cover for CROSSER loudspeakers

Code : H9985



### COV-SPRINT

Transport cover for SPRINTER loudspeakers

Code : H9986



Compatible with the CR80A-COMBO portable sound system  
Fixed frequency: UHF range (863-865 MHz) - 10 mW  
Type: Cardioid condenser microphone  
Frequency response: 70 - 18 kHz

Compatible with the CR12A-COMBO portable sound system  
16 selectable frequencies (823-832 and 863-865 MHz) - 10 mW  
Type: Cardioid condenser microphone  
Frequency response: 70 - 18 kHz

# PORTABLE SOUND SYSTEMS



## JOGGER60

Battery-powered portable sound system, 60 W, with USB/SD reader, one UHF microphone and one wired microphone

Code : H9894



Power rating: 60 W (2-way)  
Loudspeaker: 5" loudspeaker + 1" driver  
Microphones supplied: One wired microphone and one hand-held UHF microphone, 16 selectable frequencies  
**New 4G-compatible frequency ranges: UHF 823 to 832 MHz and 863 to 865 MHz**  
Source: USB/SD/MP3 reader  
Inputs: One LINE input on 3.5 mm stereo jack, one MIC input on 6.35 mm jack  
Outputs: One Mix output, LINE level, on 3.5 mm jack  
Battery: 1x Lithium 14.4 V 2.6 Ah  
Battery life: 4 hours (average)  
Weight: 2.9 kg  
Dimensions: 290 x 160 x 210 mm  
Accessories supplied: carrying bag, lithium battery, mains adapter, infrared remote control

Options: Additional battery, external battery charger



## JOGGER50

Battery-powered portable sound system, 50 W, with USB reader, one hand-held UHF microphone and carrying bag

Code : H9587



Power rating: 50 W  
Loudspeaker: 5" speaker  
Microphones supplied: One wired microphone and one hand-held UHF microphone, 16 selectable frequencies  
**New 4G-compatible frequency ranges: UHF 823 to 832 MHz and 863 to 865 MHz**  
Source: USB/MP3 reader  
Inputs: One LINE input on 3.5 mm stereo jack, one MIC input on 6.35 mm jack  
Outputs: One Mix output, LINE level, on 3.5 mm jack  
Battery: 1x Lithium 14.4 V 2.6 Ah  
Battery life: 4 hours (average)  
Weight: 2.2 kg  
Dimensions: 290 x 160 x 210 mm  
Accessories supplied: carrying bag, lithium battery, mains adapter

Options: Additional battery, external battery charger



## LTPOW

External charger for 260 mA lithium batteries, for JOGGER systems

Code : H9591



## LT2600

260 mA lithium battery for JOGGER systems

Code : H9592



## PASSPRINT

120 W passive loudspeaker The ideal match for the SPRINTER

Code : H9983



Power rating: 120 W (2-way)  
Loudspeaker: 10" loudspeaker + 1" driver  
Supplied with a protective cover



## PASSCROSS

180 W passive loudspeaker The ideal match for the CROSSER

Code : H9984



Power rating: 180 W (2-way)  
Loudspeaker: 10" loudspeaker + 1.5" driver  
Supplied with a protective cover



JOGGER60 in carrying bag supplied, with remote control and hand-held microphone included





### RECEPT-MOD16

Slot-in UHF receiver module

Code : H9979



Slot-in UHF receiver in for EMEA-HAND and EMEA-HEAD  
16 selectable frequencies (823-832 and 863-865 MHz) - 10 mW  
Compatible with RUNNER, SPRINTER and CROSSER



### EMET-HAND

Hand-held microphone UHF transmitter

Code : H9980



Dynamic hand-held UHF microphone  
16 selectable frequencies (823-832 and 863-865 MHz) - 10 mW  
Uses two 1.5 V AA batteries (not supplied)  
Compatible with RUNNER, SPRINTER, CROSSER and JOGGER



### EMET-HEAD

Headset microphone with Pocket UHF transmitter

Code : H9981



Unidirectional headset condenser microphone + pocket UHF transmitter  
16 selectable frequencies (823-832 and 863-865 MHz) - 10 mW  
Uses two 1.5 V AA batteries (not supplied)  
Compatible with RUNNER, SPRINTER, CROSSER and JOGGER



### USB-RUN

USB reader for double slot

Code : H9982



Reads MP3 and WMA files  
Compatible with RUNNER, SPRINTER and CROSSER



### CD-RUN BT

CD/USB/SD and Bluetooth module

Code : H10184



CD, USB flash drive and SD card reader  
Bluetooth® V2.0 AVRCP  
Reads MP3 and WMA files  
Infrared remote control  
Compatible with RUNNER, SPRINTER and CROSSER



### RUN-K7

Cassette player/recorder module for SPRINTER only

Code : H8206



Player with logic controls  
Autoreverse play and recording  
Adjustable pitch  
Digital counter for locating recordings





# PORTABLE SOUND SYSTEMS



## PPA-101

Portable sound system, 50 W, with BT, FM, USB/SD reader and two UHF microphones; supplied without battery

Code : B00195



## Hand-held UHF microphone for PPA-101 (863.35 MHz)

Code : B00197



## Battery for PPA-101

12 V, 7 Ah lead-acid battery

Code : B00198



Power rating: 50 W (2-way)  
Loudspeaker: 10" loudspeaker + 1" driver  
Microphone supplied: One hand-held UHF microphone (863.35 MHz) + one headset microphone with Pocket UHF transmitter (864.80MHz)  
Source: USB/SD reader + Bluetooth® + FM tuner  
Inputs: One LINE input on 3.5 mm stereo jack, RCA or XLR, one MIC input on combined XLR/jack  
Outputs: 1 LINE level on XLR  
Battery: 1x 12 V 7 Ah (optional - code B00198)  
Battery life: 6 hours (average)  
Weight: 15.5 kg without battery  
Dimensions: 550 x 325 x 280 mm  
Accessories supplied: Built-in trolley, 12V car power cable

Options:  
TOURING BAG-PPA-101 (protective cover)



## TOURING BAG - PPA-101

Protective bag for PPA-101

Code : B00598



## PPA-121

Powerful professional portable speaker with USB/SD reader, FM, one LINE and two MIC inputs

Code : B00191



Power rating: 250 W (2-way)  
Loudspeaker: 12" loudspeaker + 1.35" driver  
Microphone supplied: No  
Source: USB/SDHC reader + FM tuner  
Inputs: One LINE input on RCA/XLR, two MIC inputs on XLR/jack  
Outputs: 1 LINE level on XL  
Battery: No  
Weight: 15 kg  
Dimensions: 580 x 372 x 315 mm  
Accessories included: Infrared remote control



### BOOMBOX

60 W battery-powered BT speaker with FM, IPX4

Code : H10483



### COV-BOOMBOX

Transport cover for BOOMBOX

Code : H10488



### Brick120

Bluetooth HiFi speaker, IPX5

Code : H10216



### Bora Bora

60 W portable outdoor speaker, IPX5

Code : H10174



Power rating: 60 W (2-way)  
Loudspeaker: 6.5" speaker + 1.5" tweeter  
Microphone supplied: No  
Source: Bluetooth/FM tuner/USB  
Inputs: One LINE input on 3.5 mm stereo jack, one MIC input on 6.35 mm jack, one MIC/guitar input on 6.35 mm jack  
Outputs: USB 5 V 1 A for smartphone charging  
Battery: 1x 4000 mAh lithium battery  
Battery life: 10 hours (average)  
Weight: 6 kg  
Dimensions: 340 x 230 x 460 mm  
Ingress protection: IPX4 (humidity-resistant)

Accessories included: Built-in trolley

Options:

**COV-BOOMBOX** (Carrying bag)

Power rating: 20 W (2-way)  
Bluetooth V4.0 AVRCP, CSR compression, APT-X, NFC pairing  
Average operating range 10 metres - Bluetooth Class 2  
Controls on top: ON/OFF, BT volume, play-pause, skip and search, battery level display  
Input: One LINE input on 3.5 mm stereo jack  
Battery life approx. 10 hours  
Weight: 650 g  
Battery: Lithium  
Dimensions: 180 x 80 x 80 mm  
Ingress protection: IPX5 (weather-resistant)  
Accessory supplied: mains battery charger

Power rating: 60 W (2-way)  
Loudspeaker: One 5.25" speaker + four 2" speakers  
Bluetooth V4.0 AVRCP, CSR compression, APT-X, NFC pairing  
Inputs: One LINE input on 3.5 mm stereo jack  
Controls on top: Standby, Volume + and -, battery level display  
Battery: 1x Lithium 14.8 V 2600 mA  
Battery life: 8 hours (average)  
Weight: 2.9 kg  
Dimensions: Diameter 195 / Height 370 mm  
Ingress protection: IPX5 (weather-resistant)  
Accessories supplied: mains battery charger, 3.5 mm jack/3.5 mm jack stereo lead



Compatible with smartphones, tablets or other Bluetooth® transmitters, the BoraBora speaker is very easy to connect and offers large freedom of movement. It is NFC-compatible: simply bring up your device to pair. It features an AUX input for broadcasting sound from non-Bluetooth® sources.

#### 8 HOURS WITH NO WORRIES

BoraBora can run for 8 hours on battery power, for a charging time of only 2 hours, and can of course be used on mains power via the supplied adapter.

#### ENJOY THE OPEN AIR

Weather-resistant, with sufficient power for outdoor use, the BoraBora speaker features 360° playback to ensure that it is always at the centre of your activities.





# COMMERCIAL AUDIO

BROADCASTING  
AMPLIFIERS  
MULTI SOURCE PLAYERS  
HEARING LOOP SYSTEMS

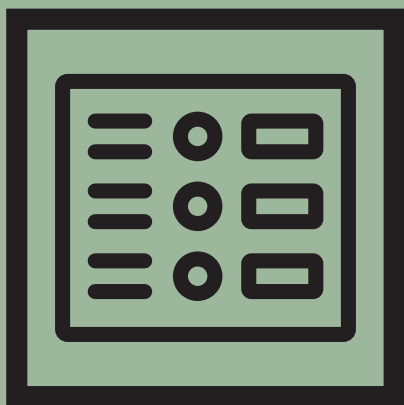

# BROADCASTING

## The time of the austere public address is over.

The name "Commercial Audio" is becoming more important for AUDIOPHONY PA.

Nowadays, these ranges are installed for their sound quality in chic and trendy places, but also in domestic settings. Their faithful reproduction of sound is one of the most important points, combined with aesthetics and simplicity.

## AUDIOPHONY PA Commercial Audio, of course.

With the "Commercial Audio" range, you have a commercial broadcasting medium in shops, bars, public areas, etc.

Good sound quality is a distinct advantage. This is without mentioning our know-how in professional and institutional areas, with a range of easy-to-use products, capable of easing all your indoor, as well as outdoor, constraints.



**NEW**



**SpeakUP**  
Active lectern 40 W + MP3 / record + HF microphone

---

Code : H10830



Amplified column lectern with VHF mic.  
Built-in amplifier 40 W RMS.  
Comes with 1 gooseneck microphone and 1 VHF hand-held microphone with in-built receiver.  
1 MP3 reader/recorder module: USB/SD/MMC  
1 XLR microphone input.  
1 RCA auxiliary input.  
3 full-range loudspeakers.  
Frequency response: 100 Hz – 16 kHz  
1 recording output or 0dB line (6.35 mm jack).  
Power: 240 V 50/60 Hz  
Dimensions: 1140 x 580 x 420 mm  
Weight: 17.2 kg



**Borneo660b**  
Tropicalised installation speaker 60 Watts 2-way - 8 Ohms/100 V - Black

---

Code : H9920



Power rating: 60 W RMS  
Available power:  
60 W/20 W/15 W/10 W/5 W  
8 Ohms/100 V  
Tweeter: 1 inch  
Woofers: 6.5 inch  
Frequency response: 45 Hz – 20 kHz  
Sensitivity (1 W @ 1 m): 89 dB  
Attachment: swivel bracket  
Humidity-resistant tropicalised speaker.  
Dimensions: 340 x 220 x 200 mm  
Net weight: 3.8 kg  
Unit price – Sold by 2pcs



**Borneo660w**  
Tropicalised installation speaker 60 Watts 2-way - 8 Ohms/100 V - White

---

Code : H9911



Power rating: 60 W RMS  
Available power:  
60 W/20 W/15 W/10 W/5 W  
8 Ohms/100 V  
Tweeter: 1 inch  
Woofers: 6.5 inch  
Frequency response: 45 Hz – 20 kHz  
Sensitivity (1 W @ 1 m): 89 dB  
Attachment: swivel bracket  
Humidity-resistant tropicalised speaker.  
Dimensions: 340 x 220 x 200 mm  
Net weight: 3.8 kg  
Unit price – Sold by 2pcs





### EHP880B

Installation speaker 80 Watts  
2-way - 8 Ohms/70 V/100 V - Black

Code : H10212



### EHP880W

Installation speaker 80 Watts  
2-way - 8 Ohms/70 V/100 V - White

Code : H10213



### EHP520b

Installation speaker 40 Watts  
2-way - 8 Ohms/70 V/100 V - Black

Code : H9763



### EHP520w

Installation speaker 40 Watts  
2-way - 8 Ohms/70 V/100 V - White

Code : H9762



Power rating: 80 W RMS  
Available power: 80 W/40 W/20 W at 100 V - 40 W/20 W/10 W at 70 V  
80 W at 8 Ohms  
Tweeter: 1 inch  
Woofer: 8 inch  
Frequency response: 70 Hz - 18 kHz  
Sensitivity (1 W @ 1 m): 92 dB  
Attachment: swivel bracket  
Dimensions: 410 x 290 x 240 mm  
Net weight: 8 kg  
Unit price - Sold by 2pcs

Power rating: 80 W RMS  
Available power: 80 W/40 W/20 W at 100 V - 40 W/20 W/10 W at 70 V  
80 W at 8 Ohms  
Tweeter: 1 inch  
Woofer: 8 inch  
Frequency response: 70 Hz - 18 kHz  
Sensitivity (1 W @ 1 m): 92 dB  
Attachment: swivel bracket  
Dimensions: 410 x 290 x 240 mm  
Net weight: 8 kg  
Unit price - Sold by 2pcs

Power rating: 40 W RMS  
Available power: 40 W/20 W/10 W at 100 V - 20 W/10 W/5 W at 70 V  
40 W at 8 Ohms  
Tweeter: 1 inch  
Woofer: 5 inch  
Frequency response: 80 Hz - 18 kHz  
Sensitivity (1 W @ 1 m): 89 dB  
Attachment: swivel bracket  
Dimensions: 270 x 187 x 165 mm  
Net weight: 3.4 kg  
Unit price - Sold by 2pcs

Power rating: 40 W RMS  
Available power: 40 W/20 W/10 W at 100 V - 20 W/10 W/5 W at 70 V  
40 W at 8 Ohms  
Tweeter: 1 inch  
Woofer: 5 inch  
Frequency response: 80 Hz - 18 kHz  
Sensitivity (1 W @ 1 m): 89 dB  
Attachment: swivel bracket  
Dimensions: 270 x 187 x 165 mm  
Net weight: 3.4 kg  
Unit price - Sold by 2pcs



### EHP410b

Installation speaker 20 Watts  
2-way - 8 Ohms/70V/100V - Black

Code : H9761



### EHP410w

Installation speaker 20 Watts  
2-way - 8 Ohms/70 V/100 V - White

Code : H9760



### ROT45b

Black swivel ball mount for speakers  
EHP410b and EHP520b - 1 piece

Code : H9824



### ROT45w

White swivel ball mount for speakers  
EHP410w and EHP520w - 1 piece

Code : H9825



Power rating: 20 W RMS  
Available power: 20 W/10 W/5 W at 100 V - 10 W/5 W/2.5 W at 70 V  
20 W at 8 Ohms  
Tweeter: 1 inch  
Woofer: 4 inch  
Frequency response: 80 Hz - 18 kHz  
Sensitivity (1 W @ 1 m): 89 dB  
Attachment: swivel bracket  
Dimensions: 240 x 170 x 160 mm  
Net weight: 1.45 kg  
Unit price - Sold by 2pcs

Power rating: 20 W RMS  
Available power: 20 W/10 W/5 W at 100 V - 10 W/5 W/2.5 W at 70 V  
20 W at 8 Ohms  
Tweeter: 1 inch  
Woofer: 4 inch  
Frequency response: 80 Hz - 18 kHz  
Sensitivity (1 W @ 1 m): 89 dB  
Attachment: swivel bracket  
Dimensions: 240 x 170 x 160 mm  
Net weight: 1.45 kg  
Unit price - Sold by 2pcs

# BROADCASTING



**K-50/Black (pair)**  
Installation speaker 50 Watts  
2-way - 8 Ohms - Black

---

Code : B00668

---



Power rating: 50 W RMS  
Available power:  
50 W at 8 Ohms  
Tweeter: 1 inch  
Woofer: 5.25 inch  
Frequency response: 55 Hz - 20 kHz  
Attachment: swivel bracket  
Dimensions: 238 x 180 x 150 mm  
Net weight: 5 kg  
Price for the pair



**K-50/White (pair)**  
Installation speaker 50 Watts  
2-way - 8 Ohms - White

---

Code : B00669

---



Power rating: 50 W RMS  
Available power:  
50 W at 8 Ohms  
Tweeter: 1 inch  
Woofer: 5.25 inch  
Frequency response: 55 Hz - 20 kHz  
Attachment: swivel bracket  
Dimensions: 238 x 180 x 150 mm  
Net weight: 5 kg  
Price for the pair



**K-30/Black (pair)**  
Installation speaker 40 Watts  
2-way - 8 Ohms - Black

---

Code : B00672

---



Power rating: 40 W RMS  
Available power:  
40 W at 8 Ohms  
Tweeter: 1 inch  
Woofer: 3.5 inch  
Frequency response: 65 Hz - 20 kHz  
Attachment: swivel bracket  
Dimensions: 170 x 130 x 105 mm  
Net weight: 2.5 kg  
Price for the pair



**K-30/White (pair)**  
Installation speaker 40 Watts  
2-way - 8 Ohms - White

---

Code : B00673

---



Power rating: 40 W RMS  
Available power:  
40 W at 8 Ohms  
Tweeter: 1 inch  
Woofer: 3.5 inch  
Frequency response: 65 Hz - 20 kHz  
Attachment: swivel bracket  
Dimensions: 170 x 130 x 105 mm  
Net weight: 2.5 kg  
Price for the pair



**K-80/Black (pair)**  
Installation speaker 85 Watts  
2-way - 8 Ohms - Black

---

Code : B00670

---



Power rating: 85 W RMS  
Available power:  
85 W at 8 Ohms  
Tweeter: 1 inch  
Woofer: 8 inch  
Frequency response: 35 Hz - 20 kHz  
Attachment: swivel bracket  
Dimensions: 335 x 270 x 210 mm  
Net weight: 12.8 kg  
Price for the pair



**K-80/White (pair)**  
Installation speaker 85 Watts  
2-way - 8 Ohms - White

---

Code : B00671

---



Power rating: 85 W RMS  
Available power:  
85 W at 8 Ohms  
Tweeter: 1 inch  
Woofer: 8 inch  
Frequency response: 35 Hz - 20 kHz  
Attachment: swivel bracket  
Dimensions: 335 x 270 x 210 mm  
Net weight: 12.8 kg  
Price for the pair



**OHO-350b (pair)**  
Spherical satellite speaker 50 W RMS  
2-way - Black

---

Code : H10125

---



Power rating: 50 W RMS  
Frequency response: 100 Hz - 25 KHz  
Sensitivity (1 W @ 1 m): 89 dB  
Nominal impedance: 8 Ohms  
Tweeter: 1 inch  
Woofer: 3 inch  
Connector: Terminal block integrated in the magneticbracke  
Dimensions: 99 mm diameter  
Weight: 0.7 kg  
Price for the pair



**OHO-350w (pair)**  
Spherical satellite speaker 50 W RMS  
2-way - White

---

Code : H10124

---



Power rating: 50 W RMS  
Frequency response: 100 Hz - 25 KHz  
Sensitivity (1 W @ 1 m): 89 dB  
Nominal impedance: 8 Ohms  
Tweeter: 1 inch  
Woofer: 3 inch  
Connector: Terminal block integrated in the magneticbracke  
Dimensions: 99 mm diameter  
Weight: 0.7 kg  
Price for the pair



**MIO-Sat440b (pair)**

Wall speaker on adjustable mount  
2-way - 8 Ohms - 40 W

Code : H10154



Power rating: 40 W RMS  
Frequency response: 120 Hz - 16 KHz  
Maximum SPL (@ 1 m): 116 dB  
Nominal impedance: 8 Ohms  
Tweeter: 1 inch  
Woofer: 4 inch  
Connector: Terminal block at rear  
Dimensions: 225 x 150 x 170 mm  
Weight: 2.6 kg  
Price for the pair



**MIO-Sat225b (pair)**

Wall speaker on adjustable mount, Hi-Fi  
speaker - 8 Ohms - 25 W

Code : H10150



Power rating: 25 W RMS  
Frequency response: 200 Hz - 15 KHz  
Maximum SPL (@ 1 m): 110 dB  
Nominal impedance: 8 Ohms  
Speaker: 2 x 2.75 inches  
Connector: Terminal block integrated  
in bracket  
Dimensions: 90 x 136 x 180 mm  
Weight: 0.950 kg  
Price for the pair



**MIO-Sub8150b**

Active sub with active satellite output  
150 W + 2 x 40 W

Code : H10153



ACTIVE SUB:  
Power rating: 150 W  
Frequency response: 52 - 200 Hz  
Maximum SPL (@ 1 m): 120 dB  
Woofer: 8 inch  
Dimensions: 360 x 250 x 250 mm  
Weight: 10.3 kg  
AMPLIFICATION:  
Low level: 1 x 150 W  
Mid/high level: 2 x 40 W RMS / 4 Ohms  
Sub phase switch 0/180  
Sub and Master adjustable levels.  
Connectors: 2 x XLR/Jack Combo and  
2 x RCA line input  
Terminal block for satellites



**MIO-Sub6100b**

Active sub with active satellite output  
100 W + 2 x 25 W

Code : H10149



ACTIVE SUB:  
Power rating: 100 W  
Frequency response: 50 - 200 Hz  
Maximum SPL (@ 1 m): 112 dB  
Woofer: 6.5 inch  
Dimensions: 320 x 240 x 200 mm  
Weight: 8.5 kg  
AMPLIFICATION:  
Low level: 1 x 100 W  
Mid/high level: 2 x 25 W RMS / 4 Ohms  
Sub phase switch 0/180  
Sub and Master adjustable levels.  
Connectors: 2 x XLR/Jack Combo and  
2 x RCA line input  
Terminal block for satellites



**OH0-Systema1b**

Amplified triphonic system 150 W lows -  
2 x 40 W highs

Code : H10156



This amplified triphonic system is  
consists of:  
1 x MIO-Sub8150b  
2 x OH0-350b



**MIO-Systema2b**

Amplified triphonic system 150 W lows -  
2 x 40 W highs

Code : H10152



This amplified triphonic system is  
consists of:  
1 x MIO-Sub8150b  
2 x MIO-Sat440b



**MIO-Systema1b**

Amplified triphonic system 100 W lows -  
2 x 25 W highs

Code : H10148



This amplified triphonic system is  
consists of:  
1 x MIO-Sub6100b  
2 x MIO-Sat225b



Rear view of MIO-Sub8150b



# BROADCASTING



## CHF860

Hi-Fi ceiling recessed speaker 60 Watts  
2-way - 8 Ohms

Code : H9909



2-way speaker  
Power rating: 60 W RMS  
Impedance: 8 Ohms  
Tweeter: 1 inch  
Woofer: 6.5 inch  
Frequency response: 40 Hz - 20 kHz  
Sensitivity >90dB  
External dimensions (diameter and depth):  
280 x 180 mm  
Drilling diameter: 247 mm  
Net weight: 2.48 kg



## CHP660

Ceiling recessed speaker  
2-way - 60 W / 8 Ohms - 10 W / 100 V

Code : H9910



Power rating: 60 W RMS  
Available power:  
60 W at 8 Ohms  
10 W / 5 W / 2.5 W / 1.25 W at 100 V  
Tweeter: 1 inch  
Woofer: 6.5 inch  
Frequency response: 56 Hz - 20 kHz  
Sensitivity (1 W @ 1 m): 90 dB  
External dimensions (diameter and depth):  
240 x 140 mm  
Drilling diameter: 208 mm  
Net weight: 1.75 kg



## CHP620

Ceiling recessed speaker  
2-way 20 W / 100 V

Code : H9757



Power rating: 20 W RMS  
Available power:  
20 W / 10 W at 100 V  
Tweeter: 1.5 inch  
Woofer: 6.5 inch  
Frequency response: 85 Hz - 18 kHz  
Sensitivity (1 W @ 1 m): 98 dB  
External dimensions (diameter and depth):  
233 x 118 mm  
Drilling diameter: 200 mm  
Net weight: 1.7 kg



## CHP610

Ceiling recessed speaker  
2-way 10 W / 100 V

Code : H9756



Power rating: 10 W RMS  
Available power:  
10 W / 5 W / 2.5 W at 100 V  
Tweeter: 1.5 inch  
Woofer: 6.5 inch  
Frequency response: 56 Hz - 20 kHz  
Sensitivity (1 W @ 1 m): 93 dB  
External dimensions (diameter and depth):  
230 x 90 mm  
Drilling diameter: 200 mm  
Net weight: 1.4 kg



## CHP606

Ceiling recessed double cone speaker  
6 W / 100 V

Code : H9755



Power rating: 6 W RMS  
Available power:  
6 W / 3 W at 100 V  
Speaker: double cone 6.5 inches  
Frequency response: 110 Hz - 13 kHz  
Sensitivity (1 W @ 1 m): 90 dB  
External dimensions (diameter and depth):  
230 x 90 mm  
Drilling diameter: 200 mm  
Net weight: 0.9 kg



## CHPsub

Ceiling recessed subwoofer  
60 W / 8 Ohms - 60 W / 100 V

Code : H10533



Power rating: 60 W RMS  
Available power:  
60 W at 8 Ohms  
60 W / 40 W / 20 W at 100 V  
Frequency response: 80 Hz - 200 Hz  
Woofer: 8 inch  
Sensitivity (1 W @ 1 m): 95 dB  
Enclosed metal box  
Integrated passive filter  
External dimensions (diameter and depth):  
295 x 215 mm  
Drilling diameter: 265 mm  
Net weight: 5 kg



The two-way coaxial system fitted to the CHP620 and CHP610 ceiling speakers makes it possible to reproduce any type of music with great clarity, even at a low volume.

The presence of the tweeter is a guarantee of voice reproduction quality, and of its perfect intelligibility.



### SHP510

Suspended aluminium speaker IP55  
10 W / 100 V

Code : H9758



Power rating: 10 W RMS  
Available power:  
10 W / 5 W / 2.5 W at 100 V  
Frequency response: 150 Hz – 15 kHz  
Speaker: 5 inch  
Sensitivity (1 W @ 1 m): 90 dB  
White aluminium body,  
Ingress protection: IP55 (weather-resistant)  
Dimensions (Ø x D): 138 x 205 mm  
Weight: 2.2 kg



### PHP510

Aluminium sound projector IP55  
10 W / 100 V

Code : H9759



Power rating: 10 W RMS  
Available power:  
10 W / 5 W / 2.5 W at 100 V  
Frequency response: 150 Hz – 14 kHz  
Speaker: 5 inch  
Sensitivity (1 W @ 1 m): 90 dB  
White aluminium body,  
Ingress protection: IP55 (weather-resistant)  
Dimensions (Ø x D): 138 x 205 mm  
Weight: 2.1 kg



### PHP650

Sound projector IP55  
50 W / 100 V

Code : H10211



Power rating: 50 W RMS  
Available power:  
50 W/25/12.5/9/4.5/2.6 at 100 V  
Frequency response: 90 Hz – 20 kHz  
Speaker: 6.5 inches and 1-inch  
compression  
Sensitivity (1 W @ 1 m): 99 dB  
ABS body,  
Ingress protection: IP55 (weather-resistant)  
Dimensions: 363 x 253 x 310 mm  
Weight: 3.9 kg



### CLS220

2-speakers column  
100 V - 10/20 W

Code : H10514



Power rating: 20 W RMS  
Available power:  
20 W / 10 W at 100 V  
Speaker: 2 x 2.5 inches  
Frequency response: 250 Hz -15 KHz  
Sensitivity (1 W @ 1 m): 94 dB  
Aluminium body and grill,  
Ingress protection: IP44 (weather-resistant)  
Dimensions: 104 x 73 x 262 mm  
Weight: 1.4 kg



### CLS440

4-speakers column  
100 V - 20/40 W

Code : H10515



Power rating: 40 W RMS  
Available power:  
40 W / 20 W at 100 V  
Speaker: 4 x 2.5 inches  
Frequency response: 250 Hz -15 KHz  
Sensitivity (1 W @ 1 m): 95 dB  
Aluminium body and grill,  
Ingress protection: IP44 (weather-resistant)  
Dimensions: 104 x 73 x 402 mm  
Weight: 1.94 kg



### CLS660

6-speakers column  
100 V - 30/60 W

Code : H10516



Power rating: 60 W RMS  
Available power:  
60 W / 30 W at 100 V  
Speaker: 6 x 2.5 inches  
Frequency response: 250 Hz -15 KHz  
Sensitivity (1 W @ 1 m): 96 dB  
Aluminium body and grill,  
Ingress protection: IP44 (weather-resistant)  
Dimensions: 104 x 73 x 550 mm  
Weight: 2.6 kg

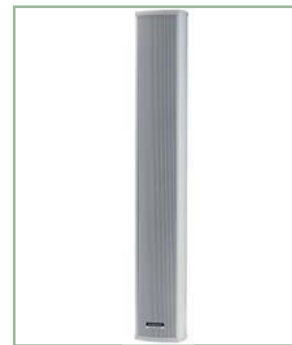

### CLS880

8-speakers column  
100 V - 40/80 W

Code : H10517



Power rating: 80 W RMS  
Available power:  
80 W / 40 W at 100 V  
Speaker: 8 x 2.5 inches  
Frequency response: 250 Hz -15 KHz  
Sensitivity (1 W @ 1 m): 97 dB  
Aluminium body and grill,  
Ingress protection: IP44 (weather-resistant)  
Dimensions: 104 x 73 x 690 mm  
Weight: 3.34 kg



# AMPLIFIERS



## WALLAMP60

Built-in stereo Hi-Fi amplifier 2 x 30 W  
2 line inputs

Code : H9908



Class-D amplifier  
2 x 30 W stereo at 8 Ohms  
A and B line inputs accessible at the front via 3.5 mm stereo jack  
A and B line inputs accessible at the back via terminal  
Input sensitivity: 280 mV  
Frequency response: 30 Hz – 20 kHz  
Power supply: DC24V included  
Casing box included  
Dimensions: 140 x 70 x 61 mm  
Net weight: 0.7 Kg



## WALLAMP-USB

Built-in stereo Hi-Fi amplifier 2 x 30 W  
2 line inputs, USB reader and IR remote control

Code : H10660



Class-D amplifier  
2 x 30 W stereo at 4 Ohms  
USB reader for MP3/WMA/WAV files  
Infrared remote control  
3-mode equaliser: speech, hall, music  
A and B line inputs accessible at the front via 3.5 mm stereo jack  
A and B line inputs accessible at the back via terminal  
Input sensitivity: 300 mV  
Frequency response: 20 Hz-20 kHz  
Power supply: DC19V included  
Dimensions: 50 x 50 x 29 mm  
Net weight: 0.11 Kg  
Compatible with PILOTBOX (H10637)  
casing box



## WALLAMP-USB PACK

Built-in Hi-Fi amplifier set

Code : H10659



Set composed of:  
1 x WALLAMP-USB  
Class-D amplifier  
2 x 30 W stereo at 4 Ohms  
USB reader + IR remote control  
2 line inputs

2 x 2-way speakers with white finish  
Power rating: 50 W RMS  
Impedance: 4 Ohms  
Tweeter: 0.75 inch  
Woofer: 4 inch  
Frequency response: 80 Hz to 20 kHz  
Sensitivity (1 W @ 1 m): 88 dB  
ABS box, metal grill  
Swivel hook attachment  
Dimensions: 245 x 160 x 160 mm  
Net weight: 1.6 kg unit



Box casing  
**PILOTBOX**  
(code H10637)

Compatible with  
**WALLAMP-USB**



## AMP480

1-way public address amplifier  
1 x 480 W at 100 V

Code : H10512



1 mono input via Phoenix plug  
1 100V output via Phoenix plug  
1 line level link output via Phoenix plug  
Channel volume adjustment  
Flat/HPF channel switch  
Output level display via 4 LED VU meters  
Access to installer settings (via screwdriver)  
Power supply: 230 V 50/60 Hz  
Frequency response: 50 Hz - 15 kHz  
T.H.D (1 kHz nominal power): 0.1%  
Dimensions: 380 x 088 x 482 mm  
19-inch rackable, Height: 2 units  
Weight: 6.6 kg



- Very high power 480 W at 100 V
- Switched-mode power supply
- Settings accessible only at the back

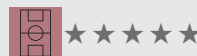



### AMP4120

4-way public address amplifier  
4 x 120 W at 100 V

Code : H10511



4 mono inputs via Phoenix plug  
4 100 V outputs via Phoenix plug  
4 line level link outputs via Phoenix plug  
Volume adjustment for each channel,  
Flat/HPF switch for each channel  
Output level display for each channel via  
4 LED VU meters  
Access to installer settings  
Power supply: 230 V 50/60 Hz  
Frequency response: 50 Hz - 15 kHz  
T.H.D (1 kHz nominal power): 0.1%  
Dimensions: 380 x 088 x 482 mm  
19-inch rackable, Height: 2 units  
Weight: 7.2kg

### AMP4240

4-way public address amplifier  
4 x 240 W at 100 V

Code : H10506



4 mono inputs via Phoenix plug  
4 100 V outputs via Phoenix plug  
4 line level link outputs via Phoenix plug  
Volume adjustment for each channel,  
Flat/HPF switch for each channel  
Output level display for each channel via  
4 LED VU meters  
Access to installer settings  
Power supply: 230 V 50/60 Hz  
Frequency response: 50 Hz - 15 kHz  
T.H.D (1 kHz nominal power): 0.1%  
Dimensions: 380 x 088 x 482 mm  
19-inch rackable, Height: 2 units  
Weight: 7.5 kg



### AMP120

Public address amplifier 120W -  
8 Ohms/70/100 V

Code : H9903



RMS power: 120 W  
Output levels / Impedance:  
- 100 V [83 Ohms]  
- 70 V [42 Ohms]  
- 4 Ohms [21.9 V]  
Balanced XLR input/output  
Power output on Phoenix plug  
Frequency response: 70 Hz - 18 KHz  
T.H.D (1 KHz): <1%  
400 Hz High-pass filter  
Power supply: 230 V 50/60 Hz  
- DC24V (safe power)  
Dimensions: 482 x 88 x 330 mm  
19-inch rackable, Height: 2 units  
Net weight: 11.6 Kg

### AMP240

Public address amplifier 240 W -  
8 Ohms/70/100 V

Code : H9904



RMS power: 240 W  
Output levels / Impedance:  
- 100 V [42 Ohms]  
- 70 V [21 Ohms]  
- 4 Ohms [31 V]  
Balanced XLR input/output  
Power output on Phoenix plug  
Frequency response: 70 Hz - 18 KHz  
T.H.D (1 KHz): <1%  
400 Hz High-pass filter  
Power supply: 230 V 50/60 Hz  
- DC24V (safe power)  
Dimensions: 482 x 88 x 330 mm  
19-inch rackable, Height: 2 units  
Net weight: 13.8 Kg



### MIC-DESK

Announcement microphone fitted with  
'push to talk' system

Code : H9748



Dynamic capsule  
Frequency response: 40 Hz to 16 kHz  
Sensitivity: -43 dB  
Impedance: 200 Ohms  
Comes with:  
1 XLR 5-pin female / DIN 5-pin male  
5 m cable.  
1 XLR 5-pin female / 6.35 mm mono  
Jack male 3 m cable.  
Dimensions: 430 x 200 x 75 mm  
Weight: 1.05 kg



### REG60

Remote volume adjuster in wall box - 60 W

Code : H9753



Power: 60 W / 100 V  
24 V Priority input  
Settings: Off/-17 dB/-11 dB/-4.5 dB/0 dB  
Frequency response: 20 Hz - 20 kHz  
White ABS body  
Fixing: REG-BOX (optional)  
Connection: 6-pin connector  
(IN+ IN- / OUT+ OUT- / 0 V 24 V)  
Dimensions: 86 x 86 x 70 mm  
Weight: 0.250 kg.



### REG-BOX

Recessed box for wall adjuster REG60

Code : H9754



# AMPLIFIERS



## COMBO240

Multi-zone combined mixer amplifier line  
100V combo 5 zones 6 inputs - 240W

Code : H9751



All-in-one 240W system with multimedia option  
6-input mixer  
5 independent simultaneous zones  
7-band graphic equalizer  
Paging, siren and chime control  
Priority mode and Phantom power on channels 1 and 2  
5-pin DIN input microphone 1  
XLR line or microphone input on channels 2 to 5  
RCA input on channel 6  
Paging input on Phoenix plug  
AMP IN and PRE-AMP OUT connections  
LINK IN and LINK OUT connections  
100 V / 8 to 4 Ohms outputs on the terminal block  
Dimensions: 420 x 320 x 88 mm  
19-inch rackable  
Weight: 10.8 kg

Optional:

### MOD1

USB/SD reader module and AM/FM  
Tuner receiver for COMBO240



- All-in-one system with multimedia option
- 6-input mixer
- 5 Switchable zones
- 7-band graphic equaliser
- Paging and chime control
- 19-inch rackable
- Removable brackets



## COMBO130

Multimedia combined mixer/amplifier/  
reader line 200V 130W Tuner and USB  
reader

Code : H9750



130W all-in-one system  
5-input mixer:  
3-way microphone - Aux1/MP3/TUNER  
-Aux2  
Low and high settings  
Mp3 and Tuner player controls  
Chime activation  
Output level VU meter  
6.35 input jack for microphones 1 and 2  
RCA input for AUX1 and AUX2  
OUT output on RCA  
Connections for FM and AM antennas  
100 V / 16 to 4 Ohms outputs on the terminal block  
Tuner receiver: AM / FM  
Autoscan, Manual scan  
FM frequencies: 87.5 MHz - 108 MHz  
AM frequencies: 522 kHz - 1620 kHz  
USB reader: mp3 files  
Functions: read, search, programming  
time setting  
Power: 220 V 50-60 Hz  
Consumption: 175 W  
Dimensions: 483 x 89 x 366 mm  
Net weight: 11.36 kg



- All-in-one system
- 5-input mixer
- Push-button chimer
- 19-inch rackable
- 70 V/100 V amplified output or low impedance
- 1 front-panel microphone input





### COMBO60

Multimedia combined mixer/amplifier/reader  
line 100V 60W Tuner and USB reader

Code : H9749



60W compact all-in-one system  
3-input mixer:  
2-way microphone - Aux1/MP3/TUNER  
Low, mid and high settings  
Mp3 and Tuner player controls  
Output level VU meter  
6.35 input jack for microphones  
AUX input and CD on RCA  
Waiting music input on Phoenix plug  
Paging input on Phoenix plug  
Connections for FM and AM antennas  
100 V / 16 / 8 / 4 Ohms outputs on the terminal block  
Tuner receiver: AM / FM  
Autoscan, Manual scan  
FM frequencies: 87,5 MHz - 108 MHz  
AM frequencies: 522 kHz - 1620 kHz  
USB reader: mp3 files  
Functions: read, search, programming  
time setting  
Power: 220 V 50-60 Hz  
Consumption: 175 W  
Dimensions: 90 x 270 x 260 mm  
Net weight: 5 kg



- Compact all-in-one system
- Integrated USB reader and tuner
- Microphone input and 2 line inputs
- Paging and waiting music compatible
- Priority safety output
- 3-band equalizer



### MOD1

USB/SD reader module and AM/FM Tuner  
receiver for COMBO240

Code : H9752



Tuner receiver: AM / FM  
Autoscan, Manual scan  
FM frequencies: 87,5 MHz - 108 MHz  
AM frequencies: 522 kHz - 1620 kHz  
USB reader: mp3 files  
Functions: read, search, programming  
Recognition of more than 2000 files and  
200 folders.  
Equalisation: Classic / Pop / Jazz / Rock  
with the LOUD function  
Technical characteristics:  
Signal-to-noise ratio: Less than 70 dB  
Frequency response: 20 Hz - 20 kHz  
THD: Less than 0.1%  
Maximum consumption: 500 mA

# AMPLIFIERS



## ZONEAMP4120

8 channels and 4 120W outputs at 100V  
Amplified mixer

Code : H10513



4 Mic/Line inputs on XLR/6.35 Jack (TRS)  
4 stereo inputs on RCA or 6.35 Mono Jack  
4 link out outputs per zone on Phoenix plug  
4 120W at 100V outputs on Phoenix plug  
Microphone priority on input 1  
Phantom power on inputs 1 to 4  
Gain and tone control (3 bands) on channels 1 to 4  
Gain control on all inputs  
Tone control (2 bands) per zone  
5 RJ45 connectors to connect 1x WP-1 per zone and to connect 1 x MIC-DESK4  
General Mute key  
Zone allocation 1 to 4 on each input  
Signal / Peak display on each input  
5 LED VU meters per zone  
AFL / PFL front panel HP monitoring  
Power supply: 230 V 50/60 Hz  
Frequency response: 20 Hz - 20 kHz  
Dimensions: 320 x 088 x 482 mm  
19-inch rackable, Height: 2 units  
Weight: 9 kg



## WP-1

Wall-mounted controller for ZONEAMP4120 or PREZONE44

Code : H10508



1 front panel XLR microphone input  
1 front panel RCA line input  
1 back panel RJ45 connection  
Front panel volume control  
ON/OFF Switch  
Source display shown by LED  
DC15V power by RJ45 cable from the ZONEAMP4120 or the PREZONE444  
Dimensions: 80 x 80 x 50 mm  
Weight: 0.2kg



## MIC-DESK4

Microphone base for ZONEAMP4120 or PREZONE444

Code : H10509



1 front panel XLR microphone input  
1 rear RJ45 output  
Talk switch on front panel to enable microphone  
Chime switch to launch chime  
Zone selection switch  
Volume setting (Microphone and Chime)  
Lock/unlock switch to block zone selection  
LED level display  
Power by RJ45 cable from the ZONEAMP4120 or the PREZONE444  
Frequency response: 45 Hz - 15 kHz  
T.H.D (1 kHz nominal power): < 0.1%  
Dimensions: 140 x 60 x 205 mm  
Weight: 0.9kg



### 8 INPUTS

Each input can be routed to your chosen zone or zones.  
Installer settings are accessible with a screwdriver.

### 4 OUTPUTS

The ZONEAMP4120 is equipped with a monitoring loudspeaker to verify the signal sent to each output.



Send your source to the zone of your choice  
Envoyez la source sur la zone de votre choix

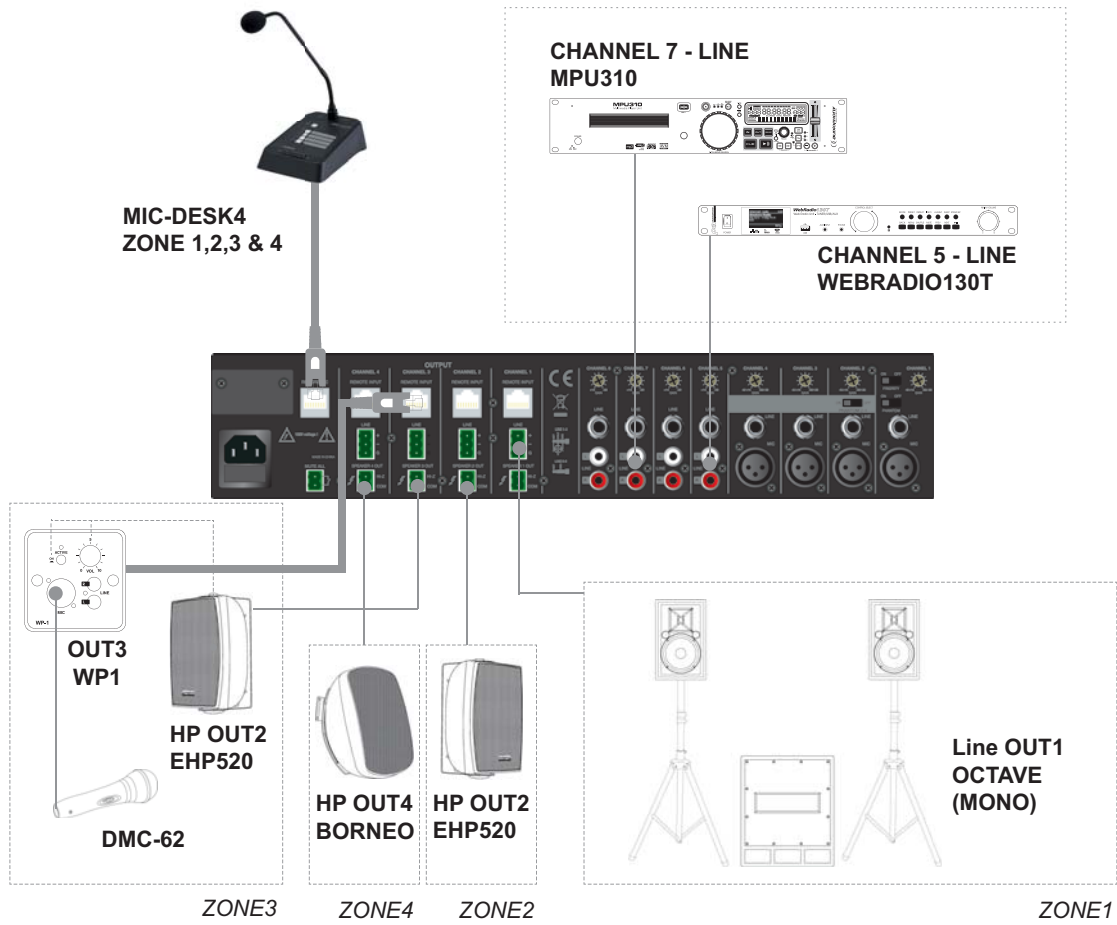

Example of usage of the  
ZONEAMP4120

More information available at: [www.audiophony.com](http://www.audiophony.com)

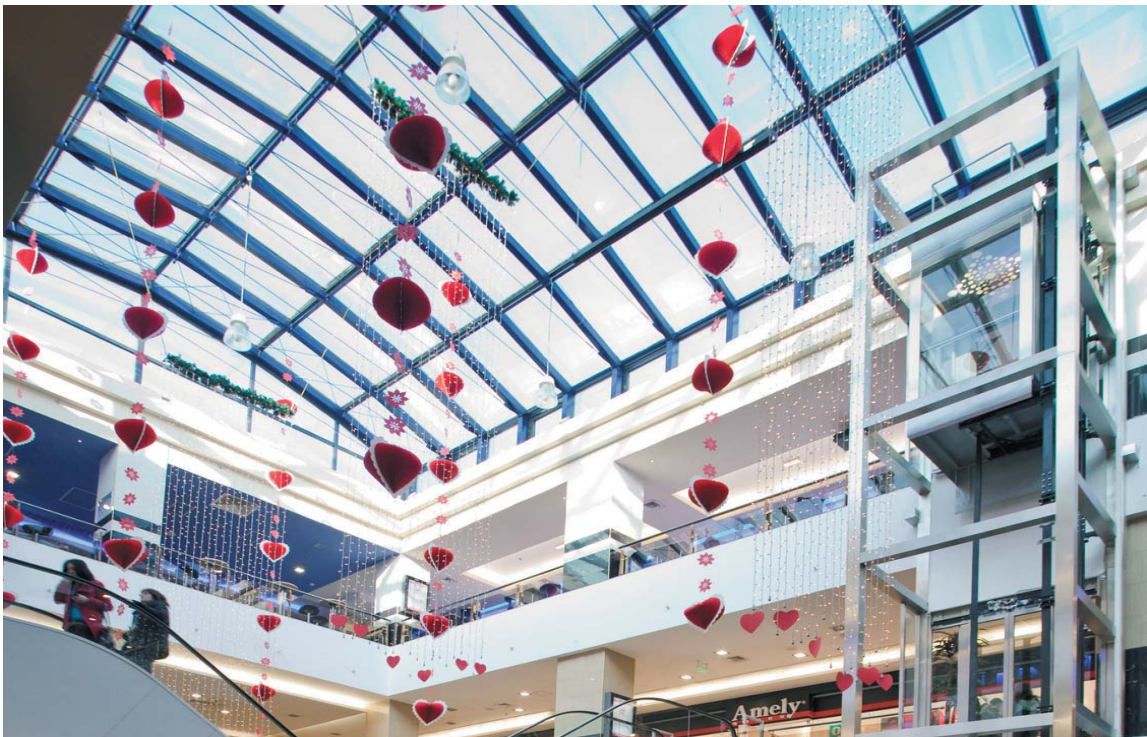

# MULTI SOURCE PLAYERS



## PREZONE444

8 channels and 4 independent output zones mixer

Code : H10507



- 4 Mic/Line inputs on XLR/6.35 Jack (TRS)
- 4 stereo inputs on RCA or 6.35 Mono Jack
- 4 line outputs per zone on Phoenix plug
- Microphone priority on input 1
- Phantom power on inputs 1 to 4
- Gain and tone (3 bands) on input 1 to 4
- Gain control on all inputs
- Tone control (2 bands) per zone
- 5 RJ45 connectors to connect 1x WP-1 per zone and to connect 1 x MIC-DESK4
- General Mute key
- Zone allocation 1 to 4, on each input
- Signal / Peak display on each input
- 5 LED VU meters per zone
- AFL / PFL front panel HP monitoring
- Power supply: 230 V 50/60 Hz DC 24V
- Dimensions: 320 x 088 x 482 mm
- 19-inch rackable, Height: 2 units Weight: 5 kg



## COMPATIBLE WP1 AND MIC-DESK4

The WP1 enables remote input from another room and to control the volume in that zone.

The MIC-DESK4 enables announcements to be made in selected zones.

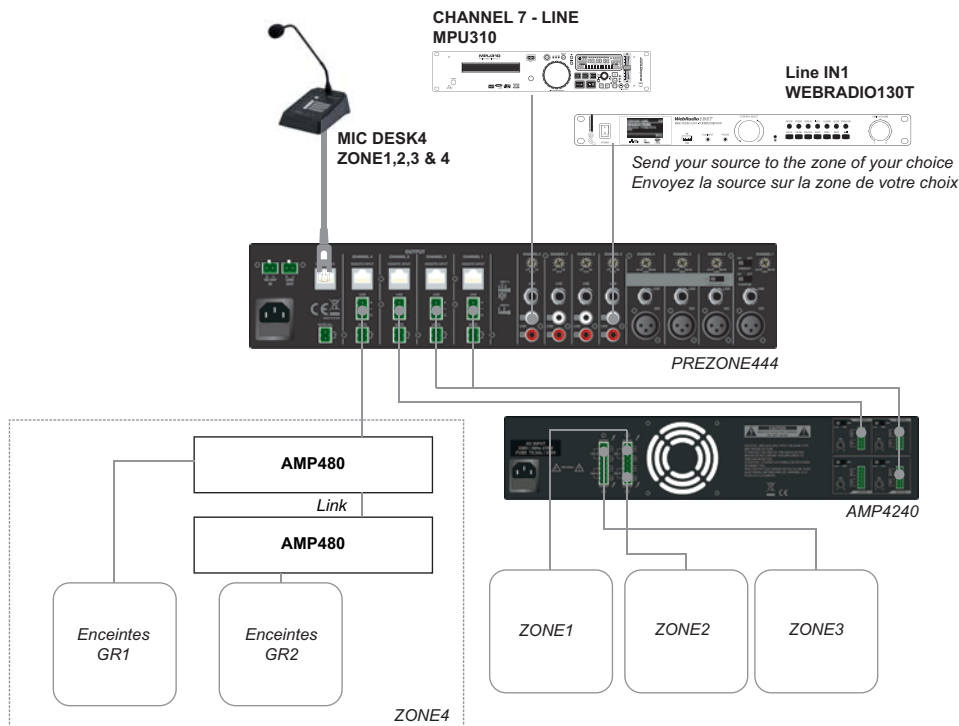



### PREZONE642

Mixer 10 inputs/Preamp 2 zones 6 microphone inputs - 4 line inputs - 2 zones

Code : H9902



6 Mic/Line inputs on XLR/6.35 Jack  
 CH1 and 2 phantom power and priority microphone  
 4 stereo inputs on RCA or Jack  
 Zones 1 and 2 balanced outputs on XLR  
 Balanced SUB output per zone on Jack  
 Stereo REC Output output on RCA  
 Gain and tone (3 bands) on inputs 1 to 4  
 Gain setting on stereo inputs  
 Tone control (2 bands) per zone  
 SUB volume per zone setting  
 Zone allocation and PFL per input  
 LED signal and Peak display  
 8 LED VU meters per zone  
 Headphone output with volume (zones and PFL)  
 Power supply: 230 V 50/60 Hz DC24V  
 Dimensions: 295 x 085 x 482 mm  
 19-inch rackable, Height: 2 units  
 Weight: 5 kg



### MICROPHONE AND LINE INPUT

#### EACH MICROPHONE INPUT HAS:

- Gain setting
- 3-band equalizer
- These settings are reserved for installation and can only be modified by means of a screwdriver

#### EACH LINE INPUT HAS:

- Gain setting. (This setting is reserved for installation and can only be modified by means of a screwdriver)

### AN ADVANCED MASTER SECTION

#### EACH ZONE HAS:

- Its own volume
- Its own equalisation
- Its own SUB output level setting
- Its own output level display

#### THE HEADPHONE SECTION IS ADVANCED WITH:

- Listening selection per channel via a PFL switch per increment
- The possibility to listen to each output independently via a zone selector.



### PM4.2 MEDIAMIX

An all-in-one solution with FM RDS, USB reader and 2-zone balanced outputs.

Code : B00124



Internal USB reader compatible with MP3, WMA and WAV files.  
 FM RDS radio with pre-set stations  
 Infrared remote control  
 Reading of 3 priority messages (manual and programmed reproduction)  
 Audio mixer up to 4 sources:  
 - USB reader/FM radio  
 - 2 external line inputs  
 - Microphone input with adjustable automatic talkover  
 Recording output per RCA plug balanced outputs per zone  
 Priority urgent message input.  
 Muting of main channels. (contact closed = muting)  
 Power supply: AC 100/240V - 50/60Hz  
 Dimensions: 483 x 44 x 162 mm  
 Net weight: 3.5 kg

# MULTI SOURCE PLAYERS



## MXU230T

CD/USB/SD reader 3-way mixer + tuner

Code : H10182



CD/Mp3 reader with anti-shock memory  
 USB/SD/SDHC (FAT32 16G0 max) reader  
 Output volume control  
 AM / FM tuner with 10-memory auto-scan  
 Navigation dial  
 Aux input on 3,5mm Jack  
 Microphone 1 on front panel 6.35 jack  
 Microphones 2 and 3 on rear panel 6.35 jack  
 Outputs 1 and 2 on RCA  
 Separate line and microphone control  
 Infrared remote control supplied  
 Power supply: AC 100/240V - 50/60Hz or DC12V  
 Dimensions: 483 x 44 x 275 mm  
 Net weight: 3.4 kg



- CD/USB/SD reader to read your mp3 files on all supports
- AM/FM tuner
- Mixer to control up to 2 supplementary lines and 3 supplementary microphones



★★★★★



★★★★★



★★★★★



★★★★★



## USB3.1-RDS

CD / USB /Tuner reader

Code : B00364



The USB3.1-RDS reader combines different audio sources.  
 AM/FM radio with RDS system and 18 pre-set stations  
 MP3/WMA compatible audio CD reader  
 USB/SD/SDHC reader up to 64 Go MP3/WMA sampling up to 48 kHz/320 kbit/s  
 1 RCA Tuner output / 1 RCA CD output  
 1 mixed RCA output  
 RS-232 input for home automation systems  
 Power supply: AC 100/240V - 50/60Hz  
 DC 24 V back-up power supply  
 Dimensions: 482 x 44 x 330 mm  
 Net weight: 4 kg



- 1 RCA Tuner output / 1 RCA CD output
- 1 mixed RCA output
- AM/FM radio: with RDS system and 18 pre-set stations
- MP3/WMA CD reader
- USB/SD card media reader



★★★★★



★★★★★



★★★★★



★★★★★



### MPU130T

CD MP3 + USB /SD reader + tuner

Code : H9764



CD/Mp3 reader with anti-shock memory  
 USB/SD/SDHC (FAT32 16GB max) reader  
 Output volume control  
 AM / FM tuner with 10-memory auto-scan  
 Navigation dial  
 Programmable or random shuffle playlist  
 Single-ended output (-10 dB) on RCA  
 Infrared remote control supplied  
 Power supply: AC 100/240V - 50/60Hz or DC12V  
 Dimensions: 482 x 44 x 275 mm  
 Net weight: 3.4 kg

### SOURCE CONTROL

The MPU130T is a true multimedia centre capable of supplying a continuous sound atmosphere no matter what the source is.

It's very easy to use thanks to its single output, it can be controlled independently by remote control, or directly from the front panel. Its USB and SD ports give access to hundreds of hours of non-stop music that can be pre-programmed or read randomly.



★★★★★



★★★★★



★★★★★



★★★★★



### WEBRADIO130T

Connected multimedia reader

Code : H10183



Radio: Ethernet / Wifi Internet radio, DAB and DAB+ digital radio, FM with RDS  
 Mp3 reader: USB port for reading mp3/AAC/WMA/FLAC files on USB flash drive or FAT32 external disk drive  
 Shared files: Audio file sharing available on your computer network to pool your favourite playlists  
 Programmable power on:  
 Infrared remote control  
 Aux input on 3.5mm Jack  
 Line level outputs on RCA and Headphone on 3.5mm Jack  
 Power supply: 230V - 50/60Hz or DC12V  
 Dimensions: 483 x 44 x 265 mm  
 Net weight: 2.9 kg



- Internet or DAB radio for an international selection of digital music
- USB port to play MP3 files on your hard drive
- Share audio files on your computer network



★★★★★



★★★★★



★★★★★



★★★★★



# HEARING LOOP SYSTEM

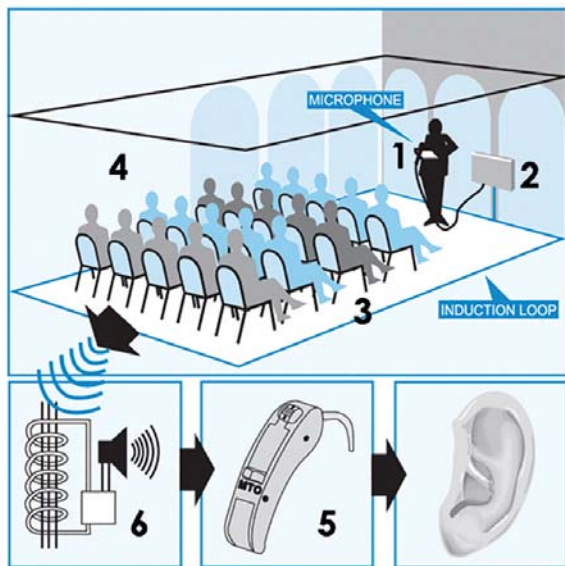

## ABOUT THE HEARING LOOP SYSTEM

A hearing loop or induction loop is a hearing aid system for the hearing-impaired using a magnetic induction loop.

With this system, the sound from a speaker's microphone, PA equipment, TV set, etc. is transmitted wirelessly to the hearing aid of the person, who can hear it without being disturbed by any ambient noise. This system is mainly used in public places (conference rooms, cinemas, courts, churches, counters, etc.)

A large number of conventional hearing aids incorporate the "T" loop function.

Hearing loops are mainly installed in rooms.

The installation consists of an electrical wire that travels around the perimeter of the room thus forming a loop. This loop is connected to an audio amplifier. The hearing aid has a coil, often called "T" or "T-coil".

This coil, placed inside the hearing aid, is also made of a wire that makes a large number of turns.

## MAGNETIC FIELD

The magnetic field generated by the large loop around the room will cross the small loops in the hearing aid and, by the principle of induction, the electrical signal present in the large loop will end up in the small ones.

This is how the signal from the audio amplifier is transmitted to the hearing aid, which will then return it to the ear of the hearing-impaired person.



## REGULATIONS

The 2005 - 102 Act of 11 February 2005 sets out the requirement for public establishments to be accessible to people with disabilities before 1 January 2018

This obviously applies to establishments open to the public, such as:

Administrative and cultural facilities,

Health buildings,

Sports facilities,

But also supermarkets, cinemas, public transport, etc.

Facilities must comply with the standard: EN 60118-4:

Background noise (electromagnetic pollution) must be < 32 dB at 400 mA/m

The magnetic field must be between +/- 3 dB for a signal from 1 kHz to 400 mA/m

The frequency response must be 100 Hz - 5 kHz at +/- 3dB

**NEW**



**BM-PORTABLE**  
Portable and autonomous loop amplifier

---

Code : H10799

---



This portable loop system makes it easy to equip a desk or counter. Made of ABS, it has an integrated microphone, amplifier, rechargeable battery and an induction loop for a coverage of: 1.2 m<sup>2</sup>. Charger included.

**NEW**



**BM-KIT**  
Loop amplifier kit for counter use

---

Code : H10795

---



Induction loop kit for equipping: counters, reception desks or service desks. This kit includes:  
 1 x induction loop amplifier  
 1 x surface microphone  
 1 x loop  
 1 x power supply  
 3 x "Space adapted for the hearing-impaired" stickers.  
 2 inputs: 1 microphone/line and 1 line  
 Phantom power  
 Compressor and noise limiter  
 Output protection and control  
 Power: 230 V 50/60 Hz - 12 V DC 1.5 A  
 Size: 92 x 52 x 18 mm  
 Weight: 0.850 kg

**NEW**



**BM-A250**  
Loop amplifier for 250 m<sup>2</sup> area

---

Code : H10796

---



Class D amplifier for approximately 250 m<sup>2</sup>  
 3 inputs: 2 line or microphone inputs (connector: 1 Phoenix and Combo), 1 priority 100 V input  
 Monitoring and detection of power supply, amplifier and loop faults with NO-NC relay.  
 Automatic gain control  
 Correction control due to metal losses  
 Power: 230 V 50/60 Hz  
 Size: 483 x 43 x 215 mm  
 Weight: 2.47 kg

**NEW**



**BM-A1000**  
Loop amplifier for 1000 m<sup>2</sup> area

---

Code : H10797

---



Class D amplifier for approximately 1000 m<sup>2</sup>  
 3 inputs: 2 line or microphone inputs (connector: 1 Phoenix and Combo), 1 priority 100 V input  
 Monitoring and detection of power supply, amplifier and loop faults with NO-NC relay.  
 Integrated phase shift module (output 90° or 0°)  
 Automatic gain control  
 Correction control due to metal losses  
 Power: 230 V 50/60 Hz  
 Size: 483 x 43 x 215 mm  
 Weight: 2.47 kg

**NEW**



**BM-TEST**  
Hearing aid simulator for loop amp test

---

Code : H10798

---



BM-TEST is a compact listening device for magnetic induction loop systems. It can be used in different situations:

- To determine if an induction loop is working properly
- For hearing-impaired people who do not wear a hearing aid
- For wearers of hearing aids that do not have a "T" function

The kit comprises:  
 1 x loop receiver  
 1 x headset  
 2 x AAA batteries  
 Frequency response: 20 Hz - 6 kHz  
 Battery life: >100 hours

**NEW**



**BM-SCAN**  
Magnetic field meter

---

Code : H10878

---



The BM-SCAN field strength meter has been designed to ensure that magnetic loop systems are installed and certified according to the new IEC 60118-4 standard. When these standards are met, the comfort of the user will be identical wherever he/she uses a hearing aid with the T position.

3.5 mm headphone jack socket  
 Power supply: 9 V battery (not included)

**NEW**



**BM-Cu50**  
Copper tape 50 m - 18 mm wide x 0.1 mm thick

---

Code : H10800

---



The BM-Cu50 is an 18-mm wide, 0.1-mm thick (1.8 mm<sup>2</sup> cross-section) copper tape insulated by a 0.05 mm Melinex band. Resistance +/- 10mΩ/m.  
 Cables specially designed for induction loops where the loop must go under carpets or in places not suitable for conventional cables.

50 m coil

**NEW**



**BM-Cu100**  
Copper tape 100 m - 18 mm wide x 0.1 mm thick

---

Code : H10801

---



The BM-Cu100 is a 18 mm wide, 0.1-mm thick (1.8 mm<sup>2</sup> cross-section) copper tape insulated by a 0.05 mm Melinex band. Resistance +/- 10mΩ/m.  
 Cables specially designed for induction loops where the loop must go under carpets or in places not suitable for conventional cables.

100 m coil



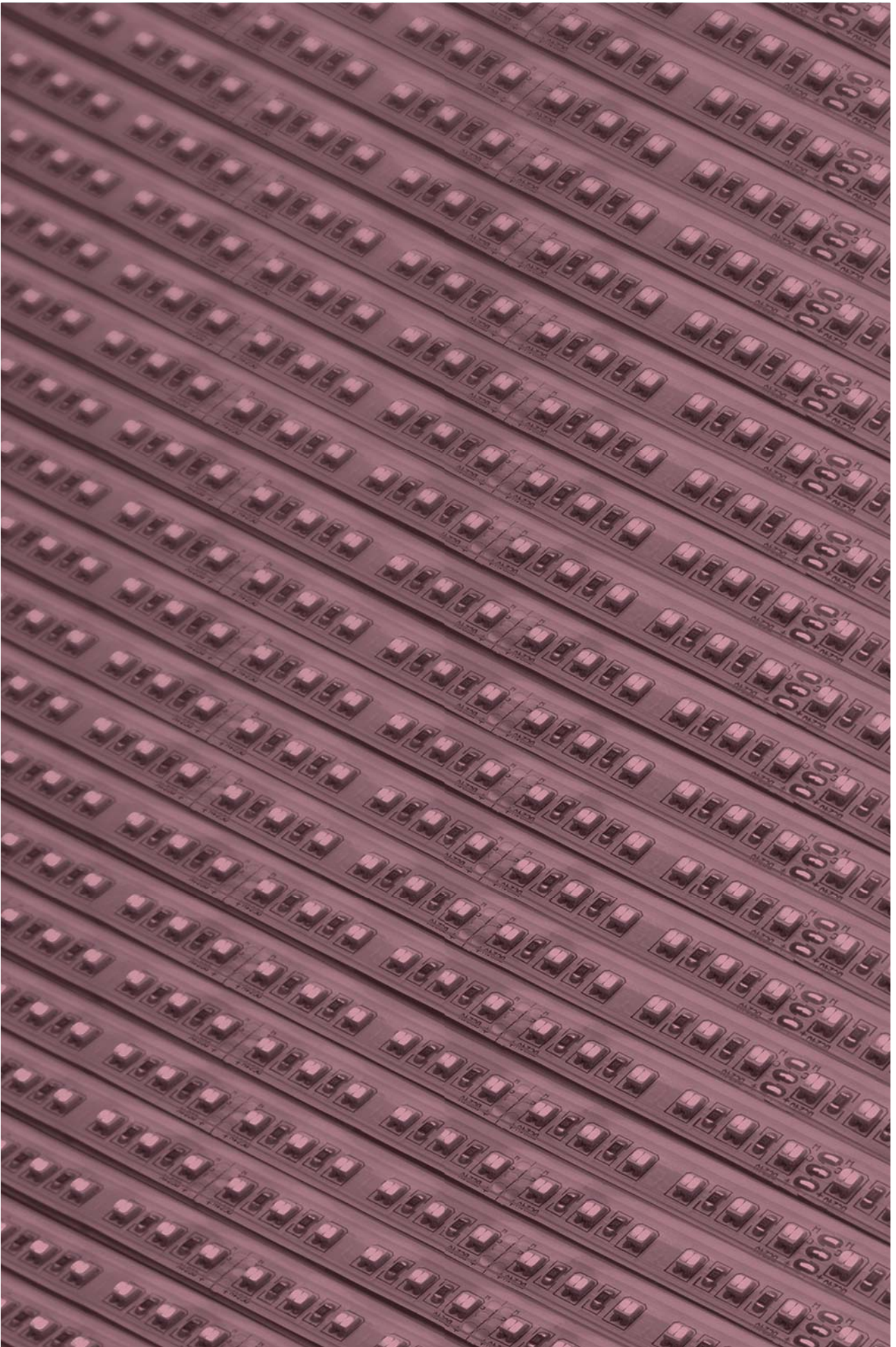

# LIGHT INTEGRATION

LED RIBBONS  
CONTROLLERS  
DRIVERS  
BOOSTERS AND MANAGERS  
POWER SUPPLIES  
PROFILES AND DIFFUSERS  
ACCESSORIES  
DECORATION PROJECTORS

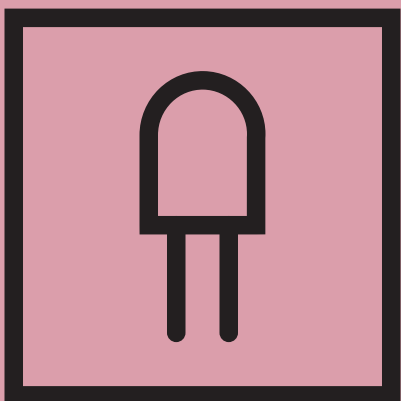



# LED RIBBONS

Intense colours, bright white or softened light, our ribbons ensure an exceptional rendering in ambient lighting as well as enhancing your spaces.

IP67	60 LEDs/m	LED SMD 5050	Ra 80
			
<p><b>PURETAPE6067-WARM</b> 3000°K White LED ribbon Roll of 5 meters - IP67 - 60 LEDs/meter</p>			
Code : H9861			
			

Monochrome adhesive ribbon of 300 warm white LEDs for 5m  
Colour temperature: 3000°K  
Luminosity: 1080 lumens/m  
Power required: 14.4W/m (72W for 5m)  
Voltage required: 24V (+ and -)  
Cuttable every 10 cm (6LEDs)  
IP67: Full silicone sheath

IP65	60 LEDs/m	LED SMD 5050	Ra 80
			
<p><b>LSI-60WW-5050-IP65-5M</b> Very bright flexible light strip (1320lm / m) containing 60 5050-SMD white LEDs/meter.</p>			
Code : B05414			
			



Monochrome adhesive ribbon of 300 warm white LEDs for 5m  
Colour temperature: 3000°K  
Luminosity: 1320 lumens/m  
Power required: 14.4W/m (72W for 5m)  
Voltage required: 24V (+ and -)  
Cuttable every 10 cm (6LEDs)  
IP65: Upper molded silicone dome

IP20	60 LEDs/m	LED SMD 5050	Ra 80
			
<p><b>PURETAPE6020-WARM</b> 3000°K White LED ribbon Roll of 5 meters - IP20 - 60 LEDs/meter</p>			
Code : H10535			
			

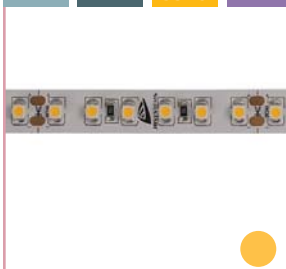

Monochrome adhesive ribbon of 300 warm white LEDs for 5m  
Colour temperature: 3000°K  
Luminosity: 915 lumens/m  
Power required: 14.4W/m (72W for 5m)  
Voltage required: 24V (+ and -)  
Cuttable every 10 cm (6LEDs)  
IP20: no protection no sealing

IP20	60 LEDs/m	LED SMD 5050	Ra 80
			
<p><b>LSI-60WW-5050-IP20-5M</b> Highly luminous flexible light strip (1320lm/m) containing 60 SMD-5050 white LEDs/meter.</p>			
Code : B05413			
			

Monochrome adhesive ribbon of 300 warm white LEDs for 5m  
Colour temperature: 3000°K  
Luminosity: 1320 lumens/m  
Power required: 14.4W/m (72W for 5m)  
Voltage required: 24V (+ and -)  
Cuttable every 10 cm (6LEDs)  
IP20: no protection no sealing

IP20	120 LEDs/m	LED SMD 3528	Ra 80
			
<p><b>LSI-120WW-3528-IP20-20M</b> JB SYSTEMS Highly luminous flexible light strip (960lm/m) containing 120 white LEDs/meter.</p>			
Code : B05412			
			

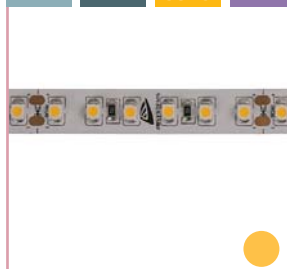
Long monochrome adhesive ribbon of 2400 warm white LEDs for 20m  
Colour temperature: 3000°K  
Luminosity: 960 lumens/m  
Power required: 9.6W/m (192W for 20m)  
Voltage required: 24V (+ and -)  
Cuttable every 5 cm (6LEDs)  
IP20: no protection no sealing

IP20	120 LEDs/m	LED SMD 3528	Ra 80
			
<p><b>LSI-120WW-3528-IP20-5M</b> JB SYSTEMS Highly luminous flexible light strip (960lm/m) containing 120 white LEDs/meter.</p>			
Code : B05410			
			

Monochrome adhesive ribbon of 600 warm white LEDs for 20m  
Colour temperature: 3000°K  
Luminosity: 960 lumens/m  
Power required: 9.6W/m (48W for 5m)  
Voltage required: 24V (+ and -)  
Cuttable every 5 cm (6LEDs)  
IP20: no protection no sealing

IP65	120 LEDs/m	LED SMD 3528	Ra 80
			
<p><b>LSI-120WW-3528-IP65-5M</b> JB SYSTEMS Highly luminous flexible light strip (960lm/m) containing 120 white LEDs/meter.</p>			
Code : B05411			
			

Monochrome adhesive ribbon of 600 warm white LEDs for 20m  
Colour temperature: 3000°K  
Luminosity: 960 lumens/m  
Power required: 9.6W/m (48W for 5m)  
Voltage required: 24V (+ and -)  
Cuttable every 5 cm (6LEDs)  
IP65: Upper molded silicone dome

IP20	144 LEDs/m	LED SMD 5630	Ra 80
			
<p><b>PURETAPE14420-WARM</b> 3000°K White LED ribbon Roll of 5 meters - IP20 - 144 LEDs/meter</p>			
Code : H10536			
			

Double monochrome adhesive ribbon of 720 warm white LEDs for 5m  
Colour temperature: 3000°K  
Luminosity: 2452 lumens/m  
Power required: 47.5W/m (238W for 5m)  
Voltage required: 24V (+ and -)  
Cuttable every 8.4 cm (12 LEDs)  
IP20: no protection no sealing



IP67	60 LEDs/m	LED SMD 5050	Ra 85
------	-----------	--------------	-------



**PURETAPE6067-COLD**  
6000°K White LED ribbon  
Roll of 5 meters - IP67 - 60 LEDs/meter

Code : H9862



Monochrome adhesive ribbon of 300  
Colour temperature: 6000°K  
Luminosity: 1170 lumens/m  
Power required: 14.4W/m (72W for 5m)  
Voltage required: 24V (+ and -)  
Cuttable every 10 cm (6LEDs)  
IP67: Full silicone sheath

IP20	60 LEDs/m	LED SMD 5050	Ra 85
------	-----------	--------------	-------



**PURETAPE6020-COLD**  
6000°K White LED ribbon  
Roll of 5 meters - IP20 - 60 LEDs/meter

Code : H10537



Monochrome adhesive ribbon of 300 cold white LEDs for 5m  
Colour temperature: 6000°K  
Luminosity: 1190 lumens/m  
Power required: 14.4W/m (72W for 5m)  
Voltage required: 24V (+ and -)  
Cuttable every 10 cm (6LEDs)  
IP20: no protection no sealing

IP20	120 LEDs/m	LED SMD 3527	Ra 80-85
------	------------	--------------	----------



**PURETAPE12020-WARMCOLD**  
3000+6000°K White LED ribbon  
Roll of 5 meters - IP20 - 120 LEDs/meter

Code : H10539



Two-tone adhesive ribbon of 600 warm and cold white LEDs for 5m  
Colour temperature: 3500K/6500K  
Luminosity: 1264 lumens/m  
Power required: 19.2 W/m (96W for 5m)  
Voltage required: 24V (+ and -)  
Cuttable every 5.3cm (6 LEDs)  
IP20: no protection no sealing

IP67	120 LEDs/m	LED SMD 3527	Ra 80-85
------	------------	--------------	----------



**PURETAPE12067-WARMCOLD**  
3000+6000°K White LED ribbon  
Roll of 5 meters - IP67 - 120 LEDs/meter

Code : H10540



Two-tone adhesive ribbon of 600 warm and cold white LEDs for 5m  
Colour temperature: 3500K/6500K  
Luminosity: 1264 lumens/m  
Power required: 19.2 W/m (96W for 5m)  
Voltage required: 24V (+ and -)  
Cuttable every 5.3cm (6 LEDs)  
IP67: Full silicone sheath

IP20	144 LEDs/m	LED SMD 5630	Ra 85
------	------------	--------------	-------



**PURETAPE14420-COLD**  
6000°K White LED ribbon  
Roll of 5 meters - IP20 - 144 LEDs/meter

Code : H10538



Double monochrome adhesive ribbon of 720 cold white LEDs for 5m  
Colour temperature: 6000°K  
Luminosity: 3065 lumens/m  
Power required: 47.5W/m (238W for 5m)  
Voltage required: 24V (+ and -)  
Cuttable every 8.4 cm (12 LEDs)  
IP20: no protection no sealing

## POSSIBLE CONFIGURATIONS

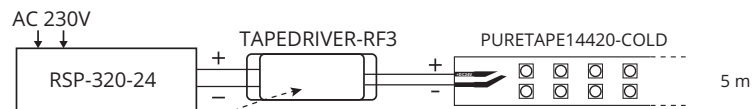
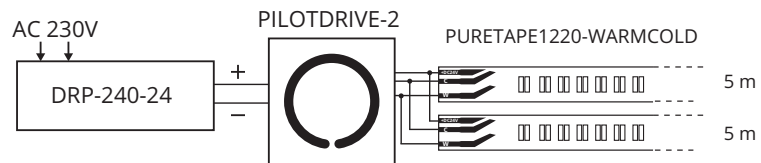

# LED RIBBONS

Intense colours, bright white or softened light, our ribbons ensure an exceptional rendering in ambient lighting as well as enhancing your spaces.

IP67

60  
LEDs/m

LED  
SMD  
5050





**COLOURTAPE6067**  
3-colour LED ribbon  
Roll of 5 meters - IP67 - 60 LEDs/meter

---

Code : H9860

---



Trichromatic adhesive ribbon of 300 RGB LEDs for 5m  
Luminosity: 510 lumens/m  
Power required: 14.4W/m [72W for 5m]  
Voltage required: 24V (+ and -)  
Cuttable every 10 cm [6LEDs]  
IP67: Full silicone sheath

IP65

60  
LEDs/m

LED  
SMD  
5050





**COLOURTAPE6065**  
3-colour LED ribbon  
Roll of 5 meters - IP65 - 60 LEDs/meter

---

Code : H9994

---



Trichromatic adhesive ribbon of 300 RGB LEDs for 5m  
Luminosity: 510 lumens/m  
Power required: 14.4W/m [72W for 5m]  
Voltage required: 24V (+ and -)  
Cuttable every 10 cm [6LEDs]  
IP65: Upper molded silicone dome

IP65

60  
LEDs/m

LED  
SMD  
5050





**LSI-60RGB-5050-IP65-5M**  
JB SYSTEMS Flexible "colour changing" LED strip containing 60 RGB LEDs/meter.

---

Code : B05418

---



Trichromatic adhesive ribbon of 300 RGB LEDs for 5m  
Luminosity: 540 lumens/m  
Power required: 14.4W/m [72W for 5m]  
Voltage required: 24V (+ and -)  
Cuttable every 10 cm [6LEDs]  
IP65: Upper molded silicone dome

IP20

60  
LEDs/m

LED  
SMD  
5050





**COLOURTAPE6020**  
3-colour LED ribbon  
Roll of 5 meters - IP20 - 60 LEDs/meter

---

Code : H10541

---



Trichromatic adhesive ribbon of 300 RGB LEDs for 5m  
Luminosity: 560 lumens/m  
Power required: 14.4W/m [72W for 5m]  
Voltage required: 24V (+ and -)  
Cuttable every 10 cm [6LEDs]  
IP20: no protection no sealing

IP20

60  
LEDs/m

LED  
SMD  
5050





**LSI-60RGB-5050-IP20-5M**  
Flexible "colour changing" LED strip containing 60 RGB LEDs/meter.

---

Code : B05417

---



Trichromatic adhesive ribbon of 300 RGB LEDs for 5m  
Luminosity: 540 lumens/m  
Power required: 14.4W/m [72W for 5m]  
Voltage required: 24V (+ and -)  
Cuttable every 10 cm [6LEDs]  
IP20: no protection no sealing

IP20

60  
LEDs/m

LED  
SMD  
5050

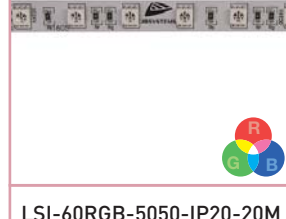



**LSI-60RGB-5050-IP20-20M**  
Flexible "colour changing" LED strip containing 60 RGB LEDs/meter.

---

Code : B05419

---



Long 3-colour adhesive ribbon of 1200 RGB LEDs for 20m  
Luminosity: 540 lumens/m  
Power required: 14.4W/m [288W for 20m]  
Voltage required: 24V (+ and -)  
Cuttable every 10 cm [6LEDs]  
IP20: no protection no sealing

IP65

30  
LEDs/m

LED  
SMD  
5050





**COLOURTAPE3065**  
3-colour LED ribbon  
Roll of 5 meters - IP65 - 30 LEDs/meter

---

Code : H9859

---



Trichromatic adhesive ribbon of 150 RGB LEDs for 5m  
Luminosity: 255 lumens/m  
Power required: 7.2W/m [36W pour 5m]  
Voltage required: 24V (+ and -)  
Cuttable every 10 cm [3LEDs]  
IP65: Upper molded silicone dome

IP65

30  
LEDs/m

LED  
SMD  
5050





**LSI-30RGB-5050-IP65-5M**  
Flexible "colour changing" LED strip containing 30 RGB LEDs/meter.

---

Code : B05416

---



Trichromatic adhesive ribbon of 150 RGB LEDs for 5m  
Luminosity: 270 lumens/m  
Power required: 7.2W/m [36W pour 5m]  
Voltage required: 24V (+ and -)  
Cuttable every 16.7 cm  
IP65: Upper molded silicone dome

IP20	30 LEDs/m	LED SMD 5050
------	-----------	--------------



**LSI-30RGB-5050-IP20-5M**  
Flexible "colour changing" LED strip containing 30 RGB LEDs/meter.

Code : B05415



Long 3-colour adhesive ribbon of 600 RGB LEDs for 20m  
Luminosity: 270 lumens/m  
Power required: 7.2W/m (36W pour 5m)  
Voltage required: 24V (+ and -)  
Cuttable every 16.7 cm  
IP20: no protection no sealing

IP65	30 LEDs/m	LED SMD 5050
------	-----------	--------------



**FL30-RGB SET-5050-3M**  
RGB flexible LED strip set, Length = 3m, incl IR-remote

Code : B05352



3-colour adhesive bars with 6x30 RGB LED strips for 3m in total  
Voltage required: 24V (+ and -)  
IP65: Upper molded silicone dome  
Complete set supplied with power supply, controller, remote control and 6 strips of 50cm.

IP67	60 LEDs/m	LED SMD 5054	Ra 80-85
------	-----------	--------------	----------



**COLOURTAPE6067-WARM**  
4-colour LED ribbon  
Roll of 5 meters - IP67 - 60 LEDs/meter

Code : H10543



Ribbon of 300 4-colour RGBW LEDs for 5m  
Luminosity: 646 lumens/m  
Power required: 19.2W/m (96W for 5m)  
Voltage required: 24V (+ and -)  
Cuttable every 10 cm (6 LEDs)  
IP67: Full silicone sheath

IP20	60 LEDs/m	LED SMD 5054	Ra 80-85
------	-----------	--------------	----------



**COLOURTAPE6020-WARM**  
LED ribbon 4-colour  
Roll of 5 meters - IP20 - 60 LEDs/meter

Code : H10542



Ribbon of 300 4-colour RGBW LEDs for 5m  
Luminosity: 879 lumens/m  
Power required: 19.2W/m (96W for 5m)  
Voltage required: 24V (+ and -)  
Cuttable every 10 cm (6 LEDs)  
IP20: no protection no sealing

IP67	30 LEDs/m	LED SMD 5050
------	-----------	--------------



**FLEXILED BLUE / 5M**  
Flexible led strip blue, L=5m, 24V

Code : B05347



Blue adhesive ribbon with 300 LEDs for 5m  
Power required: 7.2W/m (36W pour 5m)  
Voltage required: 24V (+ and -)  
Cuttable every 16.5 cm  
IP65: Upper molded silicone dome

NEW	IP20	60 LEDs/m	LED SMD 5050
-----	------	-----------	--------------



**UVRIBBON6020**  
UV ribbon - 395nm  
Roll of 5 meters - IP20 - 60 LEDs/meter

Code : H10771



UltraViolet adhesive ribbon with 300 LEDs for 5m  
Power required: 14.4W/m (72W for 5m)  
Voltage required: 24V (+ and -)  
Cuttable every 10cm (6 leds)  
IP20: no protection no sealing

NEW	IP67	60 LEDs/m	LED SMD 5050
-----	------	-----------	--------------





**UVTAPE6067**  
UV ribbon - 395nm  
Roll of 5 meters - IP67 - 60 LEDs/meter

Code : H10772

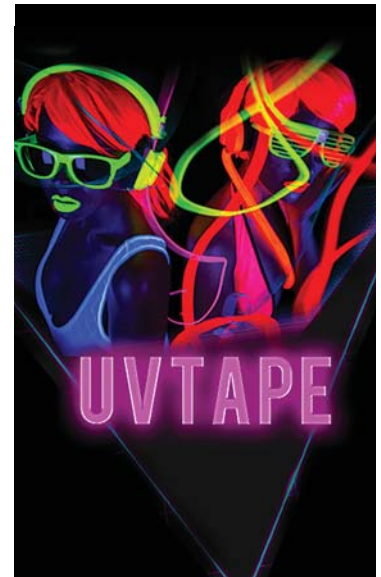

UltraViolet adhesive ribbon with 300 LEDs for 5m  
Power required: 14.4W/m (72W for 5m)  
Voltage required: 24V (+ and -)  
Cuttable every 10cm (6 leds)  
IP67: Full silicone sheath



# ADVANTAGES of the LEDs?

- Long life, low maintenance
- Low energy cost
- Resistant to shocks and vibrations
- Very compact format
- No infrared and UV emissions

Ra  
80

## RA OR CRI

An Ra equal to 100 corresponds to natural daylight. At this level, the colours are perceived without any change (or loss) for the human eye.

LEDs which diffuse artificial light cannot claim an CRI greater than 90. In places that require that colours are complied with (e.g. points of sale or exhibitions), it is essential to provide equipment with an index greater than 70).

## COLOUR TEMPERATURE

The unit of colour temperature is Kelvin degree (K°).

The lower the degree of temperature, the warmer the light. The higher the degree of temperature, the colder the light.



## WHAT TYPE OF LED?



—  
5054: 4 chips (RGBW)  
of 0.32w/led  
Good brightness

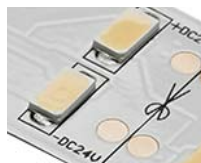

—  
5630: 1 chip of 0.33w/led  
Very high brightness  
Only monochrome



—  
5050: 3 chips (RGB) of  
0.24w/led  
Good brightness



—  
5050: 1 hot white or cold  
white chip of 0.24w/led  
High brightness

## Ideal for ambient lighting



—  
3527: 2 chips (warm white  
cold white) of 0.16w/led



—  
WS2812B:  
3 RGB chips of 0.24w/led with integrated control circuit  
Each LED can be controlled independently

The ribbons of the SMARTTAPE range are equipped with the latest WS2812B LED technology. In SMD5050 (5x5mm) format, the integrated control circuit is directly embedded in the component. More discreet, these LEDs make it possible to have ribbons of only 10mm width with a pitch of only 16mm for the SMARTTAPE6020 model.

The installation is very simple, as only 3 cables are needed for operation (+, -, Data in).

Associated with a power supply and a SMARTCTL controller, you will get 300 kinds of patterns with the ability to control the speed and brightness.



## FLEX LED PIXEL

IP20 30 LEDs/m LED WS2812B PIXEL



**SMARTTAPE3020**  
3-colour pixel LED strip of 30 LEDs/meter - IP20 - 5V

Code : H10596



3-colour adhesive ribbon of 150 RGB LEDs for 5m pixel version  
Power required: 7.2W/m (36W pour 5m)  
Voltage required: 5V DC  
Cutttable every 3.3cm (1 LED)  
IP20: no protection no sealing

IP20 60 LEDs/m LED WS2812B PIXEL



**SMARTTAPE6020**  
3-colour pixel LED strip of 60 LEDs/meter - IP20 - 5V

Code : H10597



3-colour adhesive ribbon of 300 RGB LEDs for 5m pixel version  
Power required: 14.4W/m (72W for 5m)  
Voltage required: 5V DC  
Cutttable every 1.6 cm (1 LED)  
IP20: no protection no sealing



**SMARTCTL**  
HF remote control for SMARTTAPE ribbons of 2048 pixel max. - VDC

Code : H10598



Power supply: 5V DC  
Max controlled number of pixels: 2048  
Remote control : 433.92 MHz  
Remote control range: 30m

100W 5V



**LRS-100-5**  
5V DC 100W max. power supply IP20 1 output

Code : H10600



Power supply: 5V DC 100W max.  
Output voltage : 5V DC - 20A  
Power rating: 100 W  
Supply voltage : 100 - 240V AC

50W 5V



**LRS-50-5**  
5V DC 50W max. power supply IP20 1 output

Code : H10599



Power supply: 5V DC 50W max.  
Output voltage : 5 V DC - 10 A  
Power rating: 50 W  
Supply voltage : 100 - 240V AC

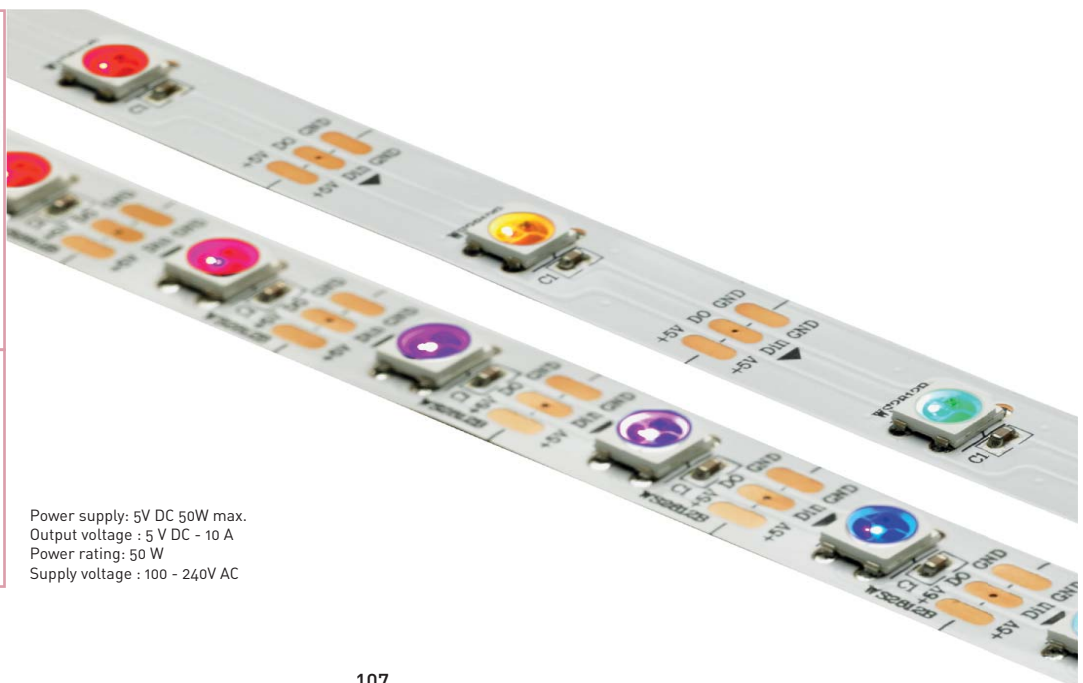



# TOUCH CONTROLLERS

Light at your fingertips.

Discover our new range of fully tactile and recessed LED light controllers. Fluid and highly accurate, choose the intensity and colour of your flex LED light with the tip of your finger.

**288 W**  
**24 V**



**PILOTdrive-1**  
Monochrome ribbon controller  
3 x 4A - 12-24V - 12A max.

Code : H10560



Function:  
- Dimmer 5% to 100% monochrome  
- Direct access to a recorded scene  
- «30S» Extinction of the ribbon after 30 seconds  
Power supply: 12 - 24V DC  
Intensity (Max load in amperes) :  
4A x 3 (outputs) = 12A max  
Dimensions: 86 x 86 x 36 mm  
Weight: 208 g  
Compatible with PILOTdrive and PILOTctl

**192W**  
**24 V**



**PILOTdrive-2**  
Controller for warm and cold white ribbons  
2 x 4A - 12 - 24V - 8A max.

Code : H10561



Function:  
- Dimmer 5% to 100% warm/cold white  
- Direct access to a recorded scene  
- "Mode" to switch between hot and cold  
Power supply: 12 - 24V DC  
Intensity (Max load in amperes) :  
4A x 2 (outputs) = 8A max  
Dimensions: 86 x 86 x 36 mm  
Weight: 208 g  
Compatible with PILOTdrive and PILOTctl

**288 W**  
**24 V**



**PILOTdrive-3**  
RGB ribbon controller  
3 x 4A - 12-24V - 12A max.

Code : H10562



Function:  
- Dimmer 5 % to 100 % RGB  
- Direct access to a recorded scene  
- 11 modes (fixed + step + fade colours)  
Power supply: 12 - 24V DC  
Intensity (Max load in amperes) :  
4A x 3 (outputs) = 12A max  
Dimensions: 86 x 86 x 36 mm  
Weight: 208 g  
Compatible with PILOTdrive and PILOTctl

**384 W**  
**24 V**



**PILOTdrive-4**  
RGBW ribbon controller  
4 x 4A - 12-24V - 16A max.

Code : H10563



Function:  
- Dimmer 5% to 100% RGBW  
- Direct access to a recorded scene  
- 12 modes- Direct access to white (fixed + step + fade colours)  
Power supply: 12 - 24V DC  
Intensity (Max load in amperes) :  
4A x 4 (outputs) = 16A max  
Dimensions: 86 x 86 x 36 mm  
Weight: 208 g  
Compatible with PILOTdrive and PILOTctl

**2,4 GHz** **DMX**  
**1 CH**



**PILOTctl-1**  
DMX controller + 2,4 GHz -1 zone - 1 colour

Code : H10564



Function:  
- Dimmer 5% to 100% monochrome  
- Direct access to a recorded scene  
- «30S» Extinction of the ribbon after 30 seconds  
Power supply: 240V  
Output signal: 2,4 GHz & DMX512  
Operating distance: 30m and 2,4 GHz  
Dimensions: 112 x 112 x 48 mm  
Weight: 225 g  
Compatible with PILOTdrive and PILOTctl

**2,4 GHz** **DMX**  
**2 CH**



**PILOTctl-2**  
DMX controller + 2,4 GHz -1 zone - 2 colours

Code : H10565



Function:  
- Dimmer 5% to 100% warm/cold white  
- Direct access to a recorded scene  
- "Mode" to switch between warm and cold white  
Power supply: 240V  
Output signal: 2,4 GHz & DMX512  
Operating distance: 30m and 2,4 GHz  
Dimensions: 112 x 112 x 48 mm  
Weight: 225 g  
Compatible with PILOTdrive and PILOTctl

**2,4 GHz** **DMX**  
**3 CH**



**PILOTctl-3**  
DMX controller + 2,4 GHz -1 zone - 3 colours

Code : H10566



Function:  
- Dimmer 5 % to 100 % RGB  
- Direct access to a recorded scene  
- 11 modes (fixed + step + fade colours)  
Power supply: 240V  
Output signal: 2,4 GHz & DMX512  
Operating distance: 30m and 2,4 GHz  
Dimensions: 112 x 112 x 48 mm  
Weight: 225 g  
Compatible with PILOTdrive and PILOTctl

**2,4 GHz** **DMX**  
**4 CH**



**PILOTctl-4**  
DMX controller + 2,4 GHz -1 zone - 4 colours

Code : H10567



Function:  
- Dimmer 5% to 100% RGBW  
- Direct access to a recorded scene  
- 12 modes (fixed + step + fade colours)  
- Direct access to white on 4 zones  
Power supply: 240V  
Output signal: 2,4 GHz & DMX512  
Operating distance: 30m and 2,4 GHz  
Dimensions: 112 x 112 x 48 mm  
Weight: 225 g  
Compatible with PILOTdrive and PILOTctl

**4 ZONES** **2,4 GHz** **DMX 4x4 CH**



**PILOTctl-16**  
DMX Controller + 2,4 GHz  
4 zones - 4 colours per zone

Code : H10568



Function

- Dimmer 5% to 100% RGBW
- Direct access to a recorded scene
- 12 modes (fixed colour + step + fade colours)
- Direct access to white

Power supply: 240V  
Output signal: 2.4 Ghz & DMX512  
Operating distance: 30m and 2.4 Ghz  
Dimensions: 112 x 112 x 48 mm  
Weight: 225 g  
Compatible with PILOTdrive and PILOTctl

**Wi-Fi** **2,4 GHz** **RGBW**



**TAPElive4**  
Wi-Fi transmitter receiver for driver  
TAPEDRIVER-WIFI4 2.4 GHz remote control

Code : H10572



Mode of communication: 2.4GHz Wi-Fi, 802.11b/g/n protocol  
Power supply: 12-24V DC  
Operating distance: Approx. 100m  
Intensity: 4A x 4 (outputs) = 16A max  
Power rating: 192W / 384W (12V / 24V)  
Dimensions: 128 x 73 x 45 mm  
Weight: 382 g

Remote Control 2.4GHz included

**2,4 GHz** **4 CH**



**TAPEDRIVER-WIFI4**  
2.4GHz wi-Fi Controller  
4 channels - 5-24VDC - 4 x 5A max.

Code : H10580



Mode of communication: 2.4GHz Wi-Fi  
Power supply: 5 - 24V DC  
Operating distance: 30m with its remote control  
Intensity: 5A x 4 (outputs) = 20A max  
Power rating: 100W / 240W / 480W (5V / 12V / 24V)  
Dimensions: 175 x 44 x 30 mm  
Weight: 150 g

## POSSIBLE CONFIGURATIONS

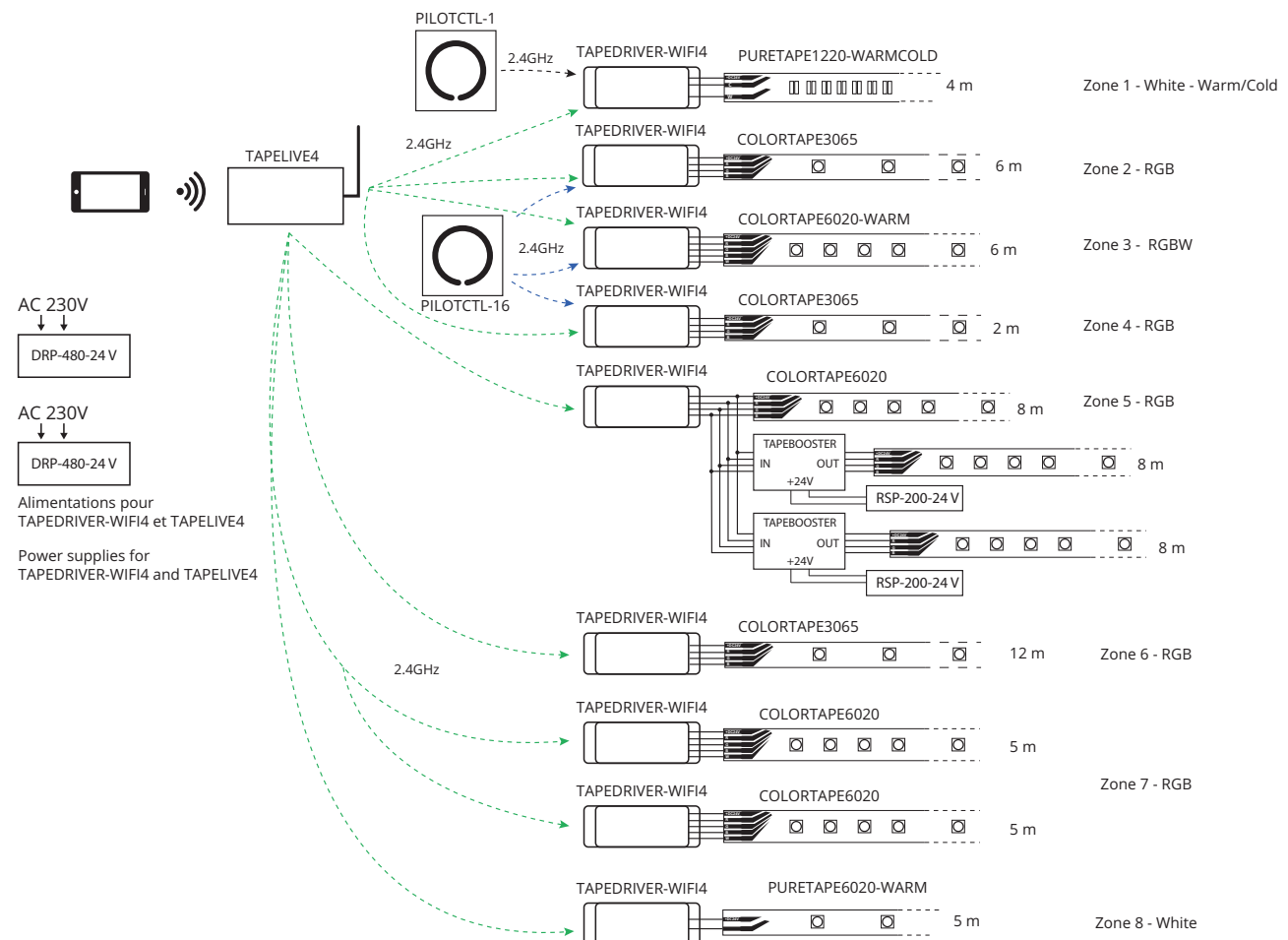

# DRIVERS

2,4 GHz 3 CH



**TAPEDRIVER-RF3**  
2.4GHz Controller  
3 channels - 5-24VDC - 3 x 6A max.

Code : H10577



Mode of communication: 2.4GHz  
Power supply: 5 - 24V DC  
Intensity (max charge in amperes) :  
6A x 3 (outputs) = 18A max  
Power rating: 90W / 216W / 432W  
(5V / 12V / 24V)  
Compatible remote control :  
REMOTERF-8W & REMOTERF-10RGB  
Operating distance: 30m  
Dimensions: 175 x 44 x 30 mm  
Weight: 150 g

2,4 GHz RGB



**TAPEDRIVERTOUCH-RF3**  
Manual controller and 2.4GHz  
3 channels - 12-24V DC - 3x 5A max.

Code : H10578



Mode of communication: 2.4GHz or manual  
Power supply: 12 - 24V DC  
Intensity (max charge in amperes) :  
5A x 3 (outputs) = 15A max  
Power rating: 180 W / 360 W (12 V / 24 V)  
Compatible remote control :  
REMOTERF-10RGB  
Operating distance: 30m  
Dimensions: 211 x 40 x 30  
Weight: 180 g

2,4 GHz 4 CH



**TAPEDRIVER-RF4**  
2.4GHz Controller  
4 channels - 5-24VDC - 4 x 5A max.

Code : H10579



Mode of communication: 2.4GHz  
Power supply: 5 - 24V DC  
Intensity (max charge in amperes) :  
5A x 4 (outputs) = 20A max  
Power rating: 100 W / 240 W / 480 W  
(5 V / 12 V / 24 V)  
Compatible remote control :  
REMOTERF-8RGBW  
Operating distance: 30m  
Dimensions: 175 x 44 x 30 mm  
Weight: 150 g

8 zones  
WHITE



**REMOTERF-8W**  
2.4GHz remote controller  
8 zones - 1 colour

Code : H10569



Mode of communication: 2.4GHz  
Power supply: DC 5V (Lithium) - Mini  
USB rechargeable battery  
Number of controlled zones: 8 zones  
Driver pilot: TAPEDRIVER-RF3  
Operating distance: 30m

10 zones  
RGB



**REMOTERF-10RGB**  
2.4GHz remote controller  
10 zones - 3 colours

Code : H10570



Mode of communication: 2.4GHz  
Power supply: DC 5V (Lithium) - Mini  
USB rechargeable battery  
Number of controlled zones: 10 zones  
- Direct access to a recorded scene  
- 11 modes (fixed + step + fade colours)  
Driver pilot: TAPEDRIVER-RF3 and  
TAPEDRIVERTOUCH-RF3  
Operating distance: 30m

8 zones  
RGBW



**REMOTERF-8RGBW**  
2.4GHz remote controller  
8 zones - 4 colours

Code : H10571



Mode of communication: 2.4GHz  
Power supply: DC 5V (Lithium) - Mini  
USB rechargeable battery  
Number of controlled zones: 8 zones  
- Direct access to a recorded scene  
- 12 modes (fixed + step + fade colours)  
- Ability to create a scene  
Driver pilot: TAPEDRIVER-RF4  
Operating distance: 30m



### NO WIRING BETWEEN THE DRIVERS



Our drivers are not wired together. The information sent by the remote control automatically synchronizes with the drivers thanks to the 2.4GHz Wi-Fi technology.



The TAPEDRIVER-RF4 is a 4-channel ribbon controller operated by the REMOTERF-8RGBW remote control. It receives information from the remote control and generates power for RGBW LED ribbons. (480W Max in 24V)

Its RGB and W LEDs will make it easier to check your installations.

### POSSIBLE CONFIGURATIONS

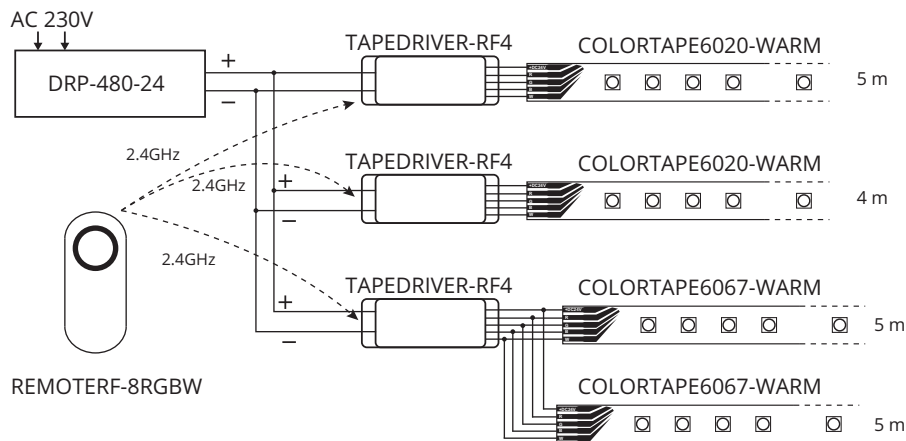

# DMX DRIVERS

Compatible with the COLOURTAPE and PURETAPE ranges, these modules convert your DMX or manual instructions into a power signal for your ribbons.

Assignable and equipped with a DMX input and output, they integrate perfectly into your installation. Combined with a suitable power supply, they can optionally control one monochrome ribbon, one RGB strip or three monochrome ribbons, one RGBW ribbon or four monochrome ribbons.



## TAPEDRIVER-1

DMX controller for ribbons  
1 channel - 12-24VDC - 6A max.

Code : H10573



For monochrome ribbon  
DMX 1 channel  
144W under 24V  
Dimmer by dip-switches  
Command in 0-10V control



## TAPEDRIVER

DMX/Power converter  
24V - 96 Watts max

Code : H9867



For monochrome and RGB ribbon  
DMX 3 channels  
96 W under 24 V  
Dimmer by dip-switches



## TAPEDRIVER-3

DMX controller for ribbons  
3 channels - 12-24VDC - 3 x 2A max.

Code : H10574



For RGB ribbon  
DMX 3 channels  
144W under 24V  
Choice of programs and colours by dip-switches



## LED DMX-CONTROL SCREW

DMX LED 12V DC / 24V DC Controller

Code : B05394



For monochrome and RGB ribbon  
DMX 4 channels  
60 W/ channel = 180 W under 12 VDC  
120 W/ channel = 360 W under 24 VDC  
Choice of programs and colours by dip-switches



## TAPEDRIVER-4

DMX controller for ribbons  
4 channels - 12-24VDC - 4 x 2.5A max.

Code : H10575



For RGBW ribbon  
DMX 4 channels  
240 W under 24 V  
Choice of programs and colours by dip-switches



## TAPEDRIVER-12

DMX controller for ribbons  
12 channels - 12-24VDC - 12 x 5A max.

Code : H10576



For all types of 24V ribbons  
DMX 12 channels  
1440 W under 24 V



## DMX OPERATION

Example for a RGB ribbon  
(3 channels)

Channel 1 : Red  
Dimmer 0%-100%

Channel 2 : Green  
Dimmer 0%-100%

Channel 3 : Blue  
Dimmer 0%-100%





### TAPEDIMMER

Dimmer for monochrome ribbon  
24V - 432 Watts maximum

Code : H9866



Compatible with monochrome ribbons  
Rotary potentiometer to adjust the output level  
Power supply: 24 V DC  
Maximum power: 432W in 24V -  
Dimensions: 112 x 65 x 24 mm  
Weight: 0.5 Kg



### LED 1CH DIM WALL

12V / 24V Wall dimmer

Code : B05392



Compatible with monochrome ribbons  
Rotary potentiometer to adjust the output level  
IR remote control for M/A, standby, dimmer, 4 levels.  
Power supply: 12 or 24V DC  
Maximum power: 160W in 24V - 80W in 12V  
Dimensions: 87 x 87 x 53 mm (box)  
Weight: 0.150 Kg



### LED 1CH DIM-CONTROL

1 12V / 24V channel dimmer

Code : B05393



Compatible with monochrome ribbons  
Rotary potentiometer to adjust the output level  
Power supply: 12 or 24V DC  
Maximum power: 160W in 24V - 80W in 12V  
Dimensions: 89 x 59 x 50 mm  
Weight: 0.065 Kg



### TAPEBOOSTER-RGBW

Compatible with 4-colour, 3-colour and monochrome ribbons, this signal booster increases the number of ribbons connected on a serial controller.

Combined with a suitable power supply, it amplifies the received signal and allows you to connect more ribbons to the same controller for longer hose lengths without discontinuity or difference in brightness.

### POSSIBLE CONFIGURATIONS

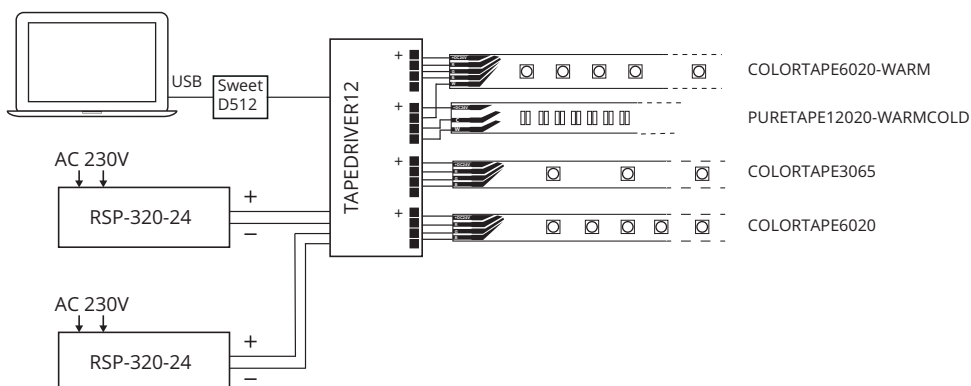

# BOOSTERS AND MANAGERS



## TAPEBOOSTER

RGB signal amplifier  
24V - 576 Watts maximum

Code : H9865



Compatible with 3-colour and monochrome ribbons  
Supply voltage: DC 24V  
Maximum output load: 3x8A  
Output signal: MLI constant voltage  
Maximum output power: 576W(24V)  
Dimensions: 107 x 65 x 24 mm  
Weight: 0.5 kg



## TAPEBOOSTER-1X10A

1 channel booster - 12-24V DC - 10A max

Code : H10769



Compatible with monochrome ribbons  
Supply voltage: DC12V-24V  
Maximum output load: 10A/CHx1  
Output signal: MLI constant voltage  
Maximum output power: 120W(12V) / 240W(24V)  
Dimensions: 125 x 45 x H36 mm  
Weight: 0.100 kg



## TAPEBOOSTER-RGBW

4 channel booster - 5-24V DC  
3 x 3A + 1 x 9A max.

Code : H10770



Compatible with 4-colour, 3-colour and monochrome ribbons  
Supply voltage : DC5V-DC24 V  
Maximum output load:  
- RGB : 3Ax3CH  
- W : 9Ax1CH  
Output signal: MLI constant voltage  
Maximum output power:  
- RGB : 72Wx3CH  
- W : 216W(24V)  
Dimensions: 176 x 46 x 30 mm  
Weight: 0.145 kg



## LED REPEATER

LED-REPEATER RVB

Code : B05400



Compatible with 3-colour and monochrome ribbons  
Supply voltage : DC12-24 V  
Output signal: MLI constant voltage  
Maximum output power:  
- RGB : 80Wx3CH under 12V  
- RGB : 160Wx3CH under 24V  
Dimensions: 90 x 90 x 24 mm  
Weight: 0.190 kg



## POWTAPE

Control and power box  
24V - 50W - Auto/DMX

Code : H9583



Compatible with 3-colour and monochrome ribbons  
Integrated power supply: DC24 V  
Maximum output power:  
- RGB : 16Wx3CH total 50W  
Integrated switch controller for:  
Master/Slave, Colours, Musical, Programs.  
4-channel DMX operation  
CTLTAPE Wall Controller Connection.  
Power supply: AC230V - 50 Hz  
Dimensions: 332 x 70 x 40 mm  
Weight: 1kg



## CTLTAPE

Built-in DMX wall-mounted controller  
4 channels - 2 program memories

Code : H9584



Compatible with 3-colour and monochrome ribbons:  
Colour adjustment by potentiometer (with access to a fade program)  
Adjustment of brightness/strobe by potentiometer  
Setting the speed in Fade mode  
2 adjustment memories  
1 bouton Black Out (ON/OFF)  
DMX 4 channels:  
Red, Green, Blue, General/Strobe Dimmer  
Power supply: DC12V - 1A (not provided)  
Dimensions: 84 x 83 x 40 mm  
Weight: 0.5 kg



## POW121

Controller power supply  
220V/12 V - 1A

Code : H9806



Power supply for CTLTAPE  
Power supply: AC 240V - 50-60Hz  
Output: 12V DC - 1A  
Protection IP20



## MINI LED MANAGER Mk3

LED DMX Power supply 100W 24V cv

Code : B04949



Compatible with 3-colour and monochrome ribbons  
Integrated power supply: DC24 V  
Maximum output power:  
- RGB : 33Wx3CH total 100W  
Integrated switch controller for:  
Master/Slave, 16 Colours, Musical, programs.  
4-channel DMX operation  
Connection CTLTAPE between wall controller and ON / OFF switch  
Power supply: AC230V - 50 Hz  
Dimensions: 356 x 132 x 43 mm  
Weight: 1.9 kg



### MICRO LED MANAGER Mk2

LED DMX Power supply 50W 24V cv

Code : B04950



Compatible with 3-colour and monochrome ribbons  
 Integrated power supply: DC24 V  
 Maximum output power:  
 - RGB : 16Wx3CH total 50W  
 Integrated switch controller for: Master/Slave, 16 Colours, Musical, programs.  
 4-channel DMX operation  
 Connection CTLTAPE between wall controller and ON / OFF switch  
 Power supply: AC230V - 50 Hz  
 Dimensions: 332 x 70 x 40 mm  
 Weight: 0.950 kg



### LED WALL DIMMER

Compact RGB remote control for LED projectors

Code : B04936



Compatible with 3-colour and monochrome ribbons:  
 Colour adjustment by potentiometer (with access to a fade program)  
 Adjustment of brightness/strobe by potentiometer  
 Setting the speed in Fade mode  
 2 adjustment memories  
 1 bouton Black Out (ON/OFF)  
 DMX 4 channels:  
 Red, Green, Blue, General/Strobe Dimmer  
 Power supply: DC12V - 1A (not provided)  
 Dimensions: 84 x 83 x 40 mm  
 Weight: 0.5 kg



### LED RF-CONTROL DIM

1 channel single colour LED controller

Code : B05396



Compatible with monochrome ribbons  
 Power: DC12-24 V  
 Maximum output power:  
 - 240 W under 12 V  
 - 480 W under 24 V  
 HF remote control (433.92 MHz) integrated for:  
 M/A, stop 30s, dimmer, levels, night light  
 RJ45 connection for Master/Slave synchronization  
 Dimensions: 90 x 90 x 24 mm  
 Weight: 0.250 kg



### LED RF-CONTROL RGB

3-channel RGB controller

Code : B05397



Compatible with tricolour ribbons  
 Power: DC12-24 V  
 Maximum output power:  
 - 240 W under 12 V  
 - 480 W under 24 V  
 HF remote control (433.92 MHz) integrated for:  
 M/A, stop 30s, dimmer, levels, night light  
 RJ45 connection for Master/Slave synchronization  
 Dimensions: 90 x 90 x 24 mm  
 Weight: 0.250 kg

## POSSIBLE CONFIGURATIONS

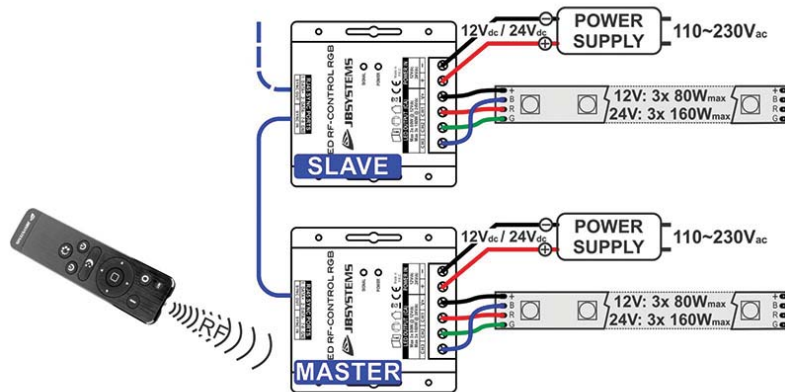

# POWER SUPPLIES



A

**POW2411P**  
Waterproof power supply for ribbon  
24V DC - 30 Watts maximum

Code : H9881



B

**EIP 060V0240LS**  
Switching power supply - 24Vdc/60W

Code : B05390



C

**POW242**  
Power supply  
24V - 50 Watts max - IP20

Code : H9807



D

**POW244IP2**  
Power supply 24VDC 4.15A  
100W max - IP65 - 2 outputs

Code : H10362



E

**LRS-100-24**  
Power supply 24VDC  
100W max. IP20 - 2 outputs

Code : H10581



F

**DR120-24**  
Power supply MW  
120W Stabilized, for DIN rail

Code : H9926



NEW

G

**ESE 150-24S**  
Switching power supply - 24Vdc/150W

Code : B05398



H

**POW246IP2**  
Power supply 24VDC 6.25A  
150W max - IP65 - 2 outputs

Code : H10316



I

**RSP-200-24**  
Power supply 24VDC  
200W max. IP20 - 3 outputs

Code : H10582



J

**DRP240-24**  
Power supply MW  
240W Stabilized, for DIN rail

Code : H9927



K

**RSP-320-24**  
Power supply 24VDC  
320W max. IP20 - 3 outputs

Code : H10583



L

**DRP480-24**  
Power supply MW  
480W Stabilized, for DIN rail

Code : H9928



	Reference	Code	Output voltage	Intensity	Power	Number of outputs	Format	IP	Dimensions
A	POW241IP	H9881	24V	1 A	30 W	1	-	IP65	218 x 30 x 22
B	EIP 060V0240LS	B05390		2.5 A	60W	1	-	IP20	157 x 54 x 36
C	POW242	H9807		2.1 A	50 W	1	-	IP20	125 x 52 x 36
D	POW244IP2	H10362		4 A	100 W	2	-	IP65	240 x 68 x 57
E	LRS-100-24	H10581		4.5A	100 W	2	A integrate	IP20	129 x 97 x 30
F	DR120-24	H9926		5 A	120 W	2	Rail	IP20	65.5 x 125.2 x 100
G	ESE 150-24S	B05398		6.25 A	150 W	2	A integrate	IP20	159 x 97 x 30
H	POW246IP2	10316		6.5 A	150 W	2	-	IP65	240 x 68 x 57
I	RSP-200-24	10582		8.4 A	200 W	3	A integrate	IP20	215 x 115 x 30
J	DRP-240-24	9927		10 A	240 W	2	Rail	IP20	125.5 x 125.2 x 100
K	RSP-320-24	10583		13.4 A	320 W	3	A integrate	IP20	215 x 115 x 3
L	DRP-480-24	9928		20 A	480 W	2	Rail	IP20	227x125,2x100

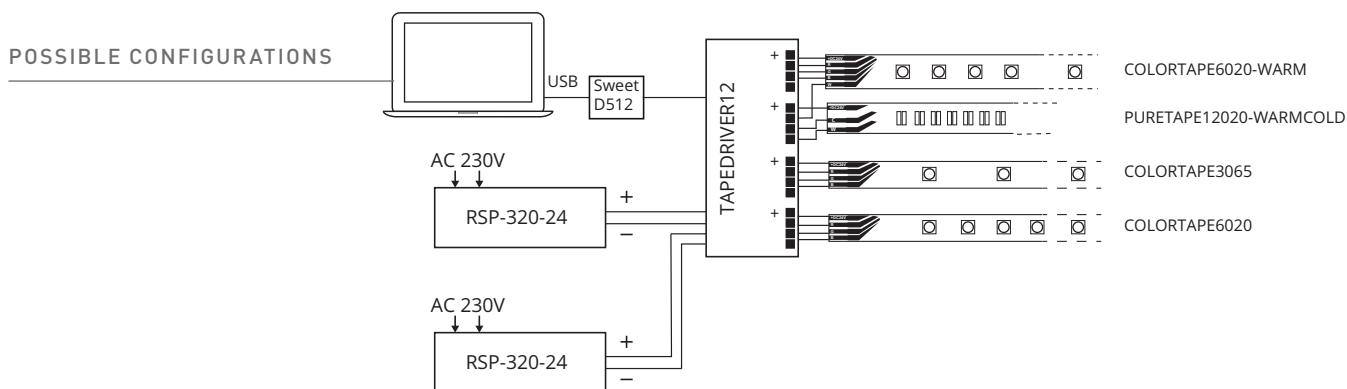

## HOW TO CHOOSE A POWER SUPPLY?

What is the consumption of a ribbon in W and which power supply should I choose?

### Example:

9m of RGB ribbon with 60 LEDs/m 14.4 W/m in 24 V (COLOURTAPE6065)

Consumption of a length L of ribbon (in W) = length (m) x power/meter (w/m)

The ribbon will consume  $14.4 \times 9 = 129.6$  W

### Power supply choice:

An additional 10% of power must be added to the power supply.

In the same example:

$129.6 + 10\% = 142.56$  W

POW246IP2 which is 150W

## WHAT LENGTH OF RIBBON?

The maximum ribbon length is not determined solely by the power of the power supply and the driver. It is also determined by the current intensity that can be supported by the ribbon circuit. You will be able to double the maximum length referenced in the table below by powering the ribbon at both ends.

		Max Length
9859	COLOURTAPE3065	16 m
10541	COLOURTAPE6020	8 m
10542	COLOURTAPE6020-WARM	5 m
9994	COLOURTAPE6065	8 m
9860	COLOURTAPE6067	8 m
10543	COLOURTAPE6067-WARM	5 m
10539	PURETAPE12020-WARMCOLD	5 m
10540	PURETAPE12067-WARMCOLD	5 m
10538	PURETAPE14420-COLD	5 m
10536	PURETAPE14420-WARM	5 m
10537	PURETAPE6020-COLD	8 m
10535	PURETAPE6020-WARM	8 m
9862	PURETAPE6067-COLD	8 m
9861	PURETAPE6067-WARM	8 m



# ALUMINUM PROFILES

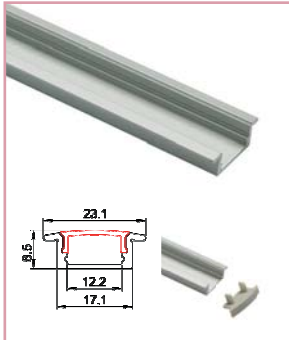

**TAPEprofil-A**  
Built-in aluminum profile 8.5 x 23 mm  
2m Length

Code : H10619

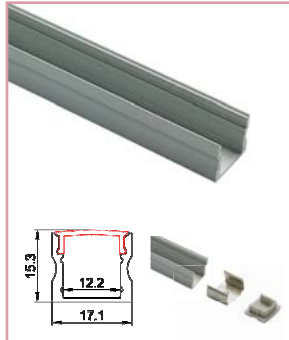

**TAPEprofil-B**  
Aluminium profile 15 x 17 mm  
2m Length

Code : H10620

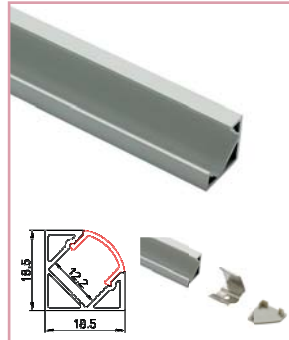

**TAPEprofil-C**  
Aluminium profile 19 x 19 mm 45°  
2m Length

Code : H10621



**TAPEprofil-D**  
Double width aluminum profile 15 x 24 mm  
2m Length

Code : H10622

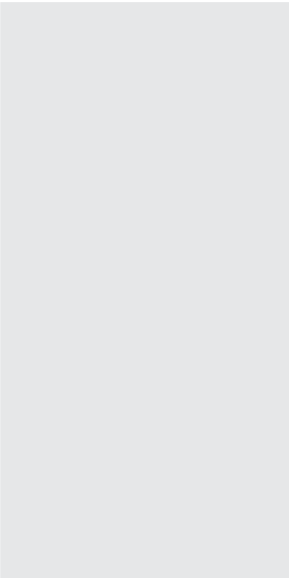

**TAPEclip-B**  
Fastening clip for B profile

Code : H10633



**TAPEclip-C**  
Fastening clip for C profile

Code : H10634



**TAPEclip-D**  
Fastening clip for D profile

Code : H10635



**TAPEcaps-A**  
Termination cap for profile A

Code : H10629



**TAPEcaps-B**  
Termination cap for profile B

Code : H10630



**TAPEcaps-C**  
Termination cap for profile C

Code : H10631



**TAPEcaps-D**  
Termination cap for profile D

Code : H10632



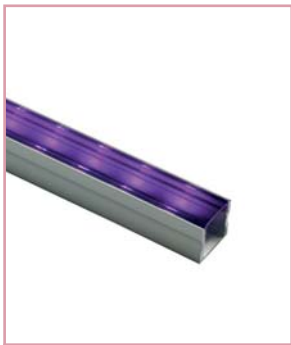

**TAPEcov-1**  
Crystal diffuser for profiles A,B,C  
2m Length

Code : H10623

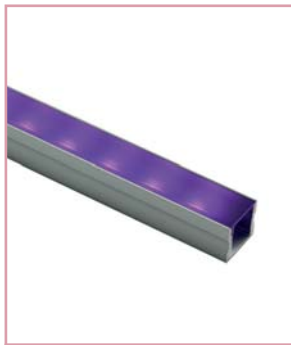

**TAPEcov-2**  
Frost diffuser for profiles A,B,C  
2m Length

Code : H10624

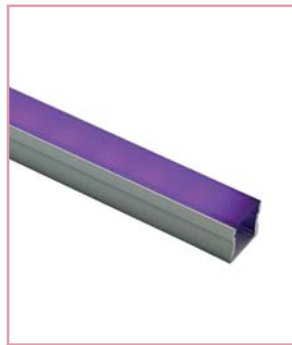

**TAPEcov-3**  
Milk diffuser for profiles A,B,C  
2m Length

Code : H10625

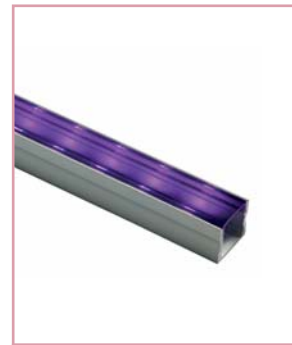

**TAPEcov-4**  
Crystal diffuser for profile D  
2m Length

Code : H10626

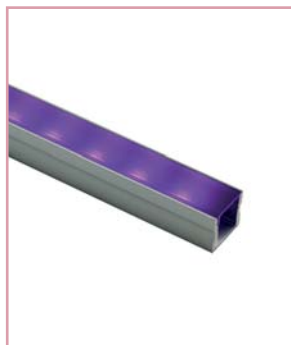

**TAPEcov-5**  
Frost diffuser for profile D  
2m Length

Code : H10627

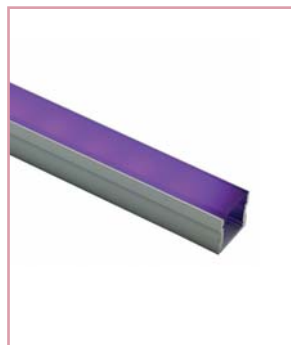

**TAPEcov-6**  
Milk diffuser for profile D  
2m Length

Code : H10628



**ALU-CORNER-15MM  
(2M)**  
Corner profile

Code : B05376



**ALU-RECESS-15MM  
(2M)**  
Built-in high profile

Code : B05371



**ALU-SURFACE-7MM  
(2M)**  
Low profile

Code : B05372



**ALU-SURFACE-15MM  
(2M)**  
High profile

Code : B05374



**THE TYPES OF LIGHT DIFFUSION**

**Milk - Opaline diffuser**  
Diffusion, it makes it possible to make signage. You do not see the LEDs

**Frost - 50% diffusing**  
Ambient lighting. It diffuses the light (if the chosen profile is deep enough).

**Crystal - Transparent**  
For lighting, it protects LEDs  
Using the cover will attenuate the brightness of the ribbon according to its opacity.



# ACCESSORIES FOR RIBBONS



**TCO-2**  
T connector for 10 mm monochrome ribbons

Code : H10549



**TCO-3**  
T connector for 2-colour 10 mm ribbons

Code : H10552



**TCO-4**  
T connector for 10 mm 3-colour ribbons

Code : H10555



**TCO-5**  
T connector for 12 mm 4-colour ribbons

Code : H10558

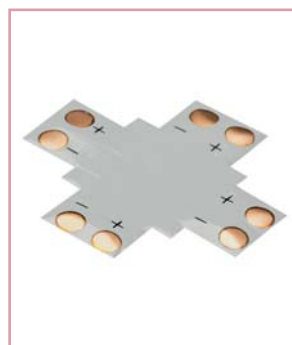

**XCO-2**  
X connector for 10 mm monochrome ribbons

Code : H10550

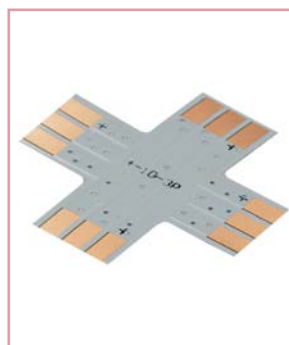

**XCO-3**  
X connector for 2-colour ribbons 10 mm

Code : H10553

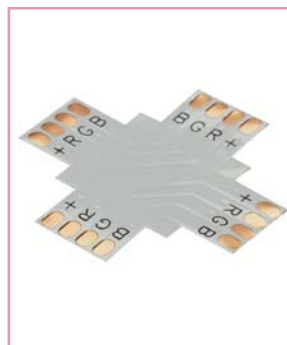

**XCO-4**  
X connector for 10 mm 3-colour ribbons

Code : H10556

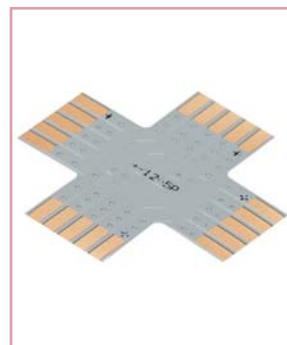

**XCO-5**  
X connector for 12 mm 4-colour ribbons

Code : H10559



**LCO-2**  
L connector for 10 mm monochrome ribbons

Code : H10548



**LCO-3**  
L connector for 2-colour ribbons 10 mm

Code : H10551



**LCO-4**  
L connector for 10 mm 3-colour ribbons

Code : H10554

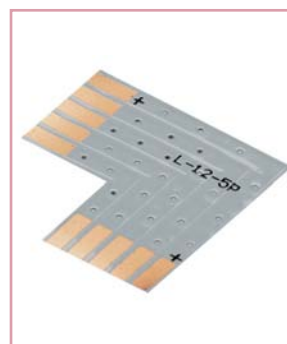

**LCO-5**  
L connector for 12 mm 4-colour ribbons

Code : H10557





A	H10637	PILOTBOX - Recessed square box 47 mm white	CONTEST®
B	H10638	PILOTSCREW - Screw steel size M3.5x20 - 1 piece (2 are needed by PILOTBOX)	CONTEST®
C	H10544	ADF1050 - Double sided adhesive width 10 mm - roll of 50 m	CONTEST®
D	H10545	ADF1250 - Double sided adhesive width 12 mm - roll of 50 m	CONTEST®
E	H10546	FLATCABLE-4 Flat cable 4 x 0.326mm <sup>2</sup> N/G/R/B - 10m	CONTEST®
F	H10547	FLATCABLE-5 - Flat cable 5 x 0,326mm <sup>2</sup> N/G/R/B/Y- 10m	CONTEST®
G	H9887	TAPELINK20 - 4-wire cords with F/F-IP20 connectors	CONTEST®
H	H9888	TAPECON4FF - 4-pin connector F / F-IP20 pack of 20	CONTEST®
I	H9883	TAPEFIX65 - Set of 15 bridges, 5 endcaps, 1 Silicone Tube	CONTEST®
J	H9884	TAPELINK61 - 4-wire cords with M/F-IP61 connectors - black	CONTEST®
K	H9885	TAPELINK65 - Connect 4-wire cords. M/F-IP65 - transparent	CONTEST®
L	H9886	TAPELINK68 - 4-wire cords M/F-IP68 connectors - white	CONTEST®
M	H9882	TAPEFIX68 - Set of 15 bridges, 5 endcaps, 1 Silicone Tube	CONTEST®
N	H9808	RGBB-100 - 4-wire electric cable for 3-colour ribbons of 50 meter	CONTEST®
O	B04944	CCM-50 - Cable to connect LED projectors to the output of our LED drivers	JB SYSTEMS®

# DECORATION PROJECTORS



## CEIL6TC-MKII

Waterproof projector with 6 LEDs 3 W  
3-colour supplied with mounting bracket.

Code : H10658



6 RGB LEDs of 3W  
Flux (Lm): 590 +/- 2.5%  
Beam opening angle of 20° - Brightness of 266 Lux at 3 m in white  
Extruded aluminium body  
Convection cooling - IP degree: 65 [total protection against dust and splashing water]  
Power supply: DC12-48V 350 mA (max) /48V  
Consumption: 18 W  
Cable: 1 m Cat.5e with 8-pin RJ45 connector  
Dimensions: Diameter 111 mm  
Length 72 mm (without cable gland) / 92 mm (with cable gland)  
Weight: 0.775 kg



## CEIL3TC-MKII

Outdoor floodlight with 3 3W TRI IP65 LED  
RJ45 connectors

Code : H10492



3 RGB LEDs of 3W  
Flux (Lm): 210 +/- 2.5%  
Beam opening angle of 40°  
Extruded aluminium body  
Convection cooling  
Compatible with MR16 mounts  
Ingress protection: IP65 [total protection against dust and splashing water]  
Power supply: DC12-48V 350 mA (max) /48V  
Consumption: 12 W  
Cable: 1 m Cat.5e with 8-pin RJ45 connector  
Dimensions: Diameter 49.5 mm [compatible MR16]  
Length 75 mm (without cable gland) / 95 mm (with cable gland)  
Weight: 0.245 kg



## PILOT60

60W control and power supply box  
RJ45 connectors

Code : H9780



Standalone operation:  
Mode master / Slave  
Automatic  
16 integrated programs  
3 free programs  
Compatible with coloured and white projectors  
DMX operation:  
RGBW projectors: from 3 to 7 channels depending on functions  
White or unicolour spotlights: from 1 to 2 channels depending on the functions  
48V output on RJ45 for projectors up to 60W maximum  
RJ45 / XLR adapter supplied for DMX connections  
Power supply : AC100-240V 50-60Hz  
Dimensions: 179 x 215 x 60 mm  
Net weight: 1.4 kg



## LD-POWER 60

Power unit for LED projectors

Code : B05120



Standalone operation:  
Mode master / Slave  
Automatic  
16 integrated programs  
3 free programs  
Compatible with colour and white projectors  
DMX operation:  
RGBW projectors: from 3 to 7 channels depending on functions  
White or unicolour spotlights: from 1 to 2 channels depending on the functions  
48V output on RJ45 for projectors up to 60W maximum  
RJ45 / XLR adapter supplied for DMX connections  
Power supply : AC100-240V 50-60Hz  
Dimensions: 179 x 215 x 60 mm  
Net weight: 1.4 kg



## PILOT120

Control and power box  
2 zones 120W - RJ45 connectors

Code : H9781



Standalone operation:  
Mode master / Slave  
Automatic  
16 integrated programs  
3 free programs  
Compatible with coloured and white projectors  
DMX operation:  
RGBW projectors: from 4 to 11 channels depending on functions  
White or unicolour spotlights: from 2 to 4 channels depending on the functions  
2 x 48V outputs on RJ45 for projectors up to 60W maximum per zone  
RJ45 / XLR adapter supplied for DMX connections  
Power supply : AC100-240V 50-60Hz  
Dimensions: 234 x 279 x 62 mm  
Net weight: 2.4 kg



## PILOT240

Control and power box  
4 zones 240W - RJ45 Connectors

Code : H9782



Standalone operation:  
Mode master / Slave  
Automatic  
15 integrated programs  
3 free programs + scheduling a calendar  
Compatible with coloured and white projectors  
DMX operation:  
RGBW projectors: from 4 to 19 channels depending on functions  
White or unicolour spotlights: from 4 to 8 channels depending on the functions  
4 x 48V outputs on RJ45 for projectors up to 60W maximum per zone  
RJ45 / XLR adapter supplied for DMX connections  
Power supply : AC100-240V 50-60Hz  
Dimensions: 280 x 309 x 90 mm  
Net weight: 4 kg



## EXPLANATIONS OF THE CALCULATION:

The number of projectors depends on the power consumption in relation to the permissible power supply. The low limit takes into account 30% of the power consumed by the cable. The high limit does not consider the cable consumption.



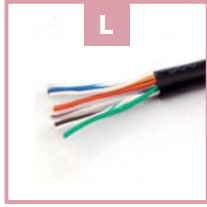
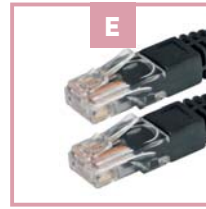
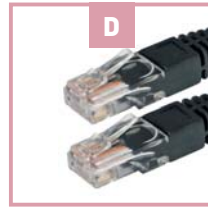
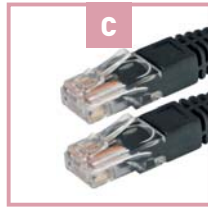
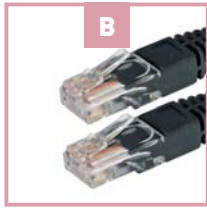
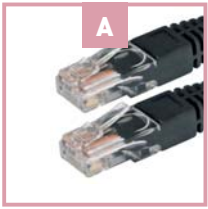

A	H9786	LINK-RJ15 - RJ45-RJ45 cable - 0.15m	CONTEST®
B	H9787	LINK-RJ50 - RJ45-RJ45 cable - 0.5m	CONTEST®
C	H9788	LINK-RJ150 - RJ45-RJ45 cable - 1.5m	CONTEST®
D	H9789	LINK-RJ300 - RJ45-RJ45 cable - 3m	CONTEST®
E	H9790	LINK-RJ500 - RJ45-RJ45 cable - 5m	CONTEST®
F	H9791	LINK-RJ1000 - RJ45-RJ45 cable - 10m	CONTEST®
G	H9792	LINK-SPLIT - RJ45 Splitter - To avoid long cable lengths between projectors	CONTEST®
	B05154	LD-SPLIT RJ45 (5pcs) - RJ45 inputs and outputs designed for CAT-5e cables. (5pcs)	BRITEQ®
H	H9793	LINK-END - Termination connector For CEIL1TC, CEIL4TC, CEIL6TC and FLAT1TC projectors	CONTEST®
	B05156	LD-TERM RJ45 (5 pcs) - Small RJ45 connection terminal.	BRITEQ®
I	H9803	LINK-IPBOX - Waterproof junction box with built-in pin connectors	CONTEST®
	B05155	LD-SPLIT - IP 68 - Plastic junction box - IP68 with inputs and outputs designed for CAT-5e cables	BRITEQ®
J	H9804	LINK-SOCKET - Male RJ45 connector covers black cable	CONTEST®
K	H9805	LINK-TOOL - Crimping pliers for RJ45 connector	CONTEST®
L	H9802	CAT5e-100 - Category 5 cable for RJ45 connector - 100m	CONTEST®
M	B05150	LD-PATCH RJ45 - 0.15M - CAT-5e cables with RJ45 connectors - 0.15M	BRITEQ®
	B05151	LD-PATCH RJ45 - 0.50M - CAT-5e cables with RJ45 connectors - 0.50M	BRITEQ®
	B05152	LD-PATCH RJ45 - 1.50M - CAT-5e cables with RJ45 connectors - 1.50M	BRITEQ®
	B05153	LD-PATCH RJ45 - 5.00M - CAT-5e cables with RJ45 connectors - 5.00M	BRITEQ®

Ribbon type



Monochrome/UV/Blue

W/WW

RGB

RGBW



PILOTdrive-1	H10560	✓	-	-	-
PILOTdrive-2	H10561	-	✓	-	-
PILOTdrive-3	H10562	-	-	✓	-
PILOTdrive-4	H10563	-	-	-	✓
PilotTOUCH	H9809	-	-	✓	-
TAPEDIMMER	H9866	✓	-	-	-
LED 1CH DIM WALL	B05392	✓	-	-	-
LED 1CH DIM-CONTROL	B05393	✓	-	-	-
TAPEDRIVER-1	H10573	✓	-	-	-
LED DMX-CONTROL SCREW	B05394	-	-	✓	-
TAPEDRIVER-3	H10574	✓	✓	✓	-
TAPEDRIVER-4	H10575	✓	✓	✓	✓
TAPEDRIVER-12	H10576	✓	✓	✓	✓
POWTAPE	H9583	-	-	✓	-
MICRO LED MANAGER Mk2	B04936	-	-	✓	-
MINI LED MANAGER Mk3	B04949	-	-	✓	-
TAPEDRIVER-RF3	H10577	✓	-	✓	-
TAPEDRIVERTOUCH-RF3	H10578	-	-	✓	-
TAPEDRIVER-RF4	H10579	-	-	-	✓
TAPEDRIVER-WIFI4	H10580	✓	✓	✓	✓
LED RF-CONTROL DIM	B05396	✓	-	-	-
LED RF-CONTROL RGB	B05397	-	-	✓	-
TAPELIVE4	H10572	✓	✓	✓	✓

REMOTERF-8W 10569	TAPEDRIVER-RF3 10577	TAPEDRIVER TOUCH-RF3 10578	TAPEDRIVER-RF4 10579	TAPEDRIVER-WIFI4 10580	TAPELIVE4 10572	TAPEDRIVER1 10573	TAPEDRIVER3 10574	TAPEDRIVER4 10575	TAPEDRIVER12 10576	MINI LED MANAGER MK3 B04949	POWTAPE H9583	MICRO LED MANAGER MK2 B04950	
REMOTERF-10RGB 10570	REMOTERF-8RGBW 10571	PILOTctl-1 10564	PILOTctl-2 10565	PILOTctl-3 10566	PILOTctl-4 10567	PILOTctl-16 10568	Pilot-TOUCH 9809	Téléphone/Tablette	TAPELIVE4 10572	Contrôleur DMX	CTLTAPE H9584	LED WALL DIMMER B04936	LEDCON-02 MK2 B04660







# LIGHTING

ARCHITECTURE PROJECTORS  
AMBIENT PROJECTORS  
BATTERY PROJECTORS  
SCENOGRAPHY PROJECTORS  
FLAT PROJECTORS  
PAR PROJECTORS  
PANELS, BLINDERS AND FLOOD  
MOVING HEADS  
SCANNERS  
ANIMATION EFFECTS  
LASERS  
STROBES  
BLACK LIGHT  
MIRROR BALLS  
CONTROLLERS  
ELECTRICAL DISTRIBUTION





# ARCHITECTURE PROJECTORS

## Designed for installation

The projectors of the IPZOOM, IPSPOT and BT-ColoRay range are equipped with ergonomics perfectly adapted to fixed or temporary installations. Their robust cast aluminium and IP65 housing allow for continuous use outdoors. The air valve avoids condensation and removes moisture from the projector.

The bright OLED or LCD display allows you to visualize & set the different menu options manually. Thanks to the use of touch buttons a waterproof barrier is maintained, without wear of buttons.



## Tight connections

IPZOOM's such as IPSPOT and BT-ColoRay are equipped with inputs and outputs dedicated to the power supply and DMX link. In order to improve discretion and ease of wiring, the IPZOOMs are equipped with waterproof chassis and plugs.

Chassis sealing is ensured by plugs. In addition to the adapters supplied, you will find a whole range of optional cables and plugs in order to make waterproof connections to other products from our range.



IP65 7x15W RGBW 12° 45° ZOOM

**IPZOOM7x15QC**  
Waterproof projector with 7x15W RGBW 4-in-1 LEDs

Code : H10657







IP65 3x15W RGBW 12° 45° ZOOM

**IPZOOM3x15QC**  
Waterproof projector with 3x15W RGBW 4-in-1 LEDs

Code : H10656





**NEW**



IP65 120W RGBW 25°

**BT-ColoRay 120R**  
LED proj. 120W RGBW COB 13° RENTAL (IP-POWER)

Code : B05509



Optics: 7x15W RGBW LEDs  
Zoom opening angle: 12° to 45°  
Integrated control unit with OLED touch panel display with drop-down menu SEETRONIC® DMX IN and OUT 3- and 5-pin plugs with waterproof plug SEETRONIC®POWER IN/OUT 3-pole plugs with waterproof plug Power supply: 100-240V/50-60Hz Power consumption: 130W Waterproofing level: IP65 Natural convection cooling Depressurisation valve with waterproof membrane Finish: cast aluminium painted black Dimensions: 270 x 320 x 320 mm Weight: 9.9 kg

Optics: 3x15W RGBW LEDs  
Zoom opening angle: 12° to 45°  
Integrated control unit with OLED touch panel display with drop-down menu SEETRONIC® DMX IN and OUT with 3- and 5-pin XLR plugs with waterproof plug SEETRONIC®POWER IN/OUT 3-pole plugs with waterproof plug Power supply: 100-240V/50-60Hz Power consumption: 70W Waterproofing level: IP65 Natural convection cooling Depressurisation valve with waterproof membrane Finish: cast aluminium painted black Dimensions: 245 x 250 x 270 mm Weight: 5.8 kg

Optics: 1x 120W RGBW COB LED  
Opening angle: 25°  
Integrated control unit with LCD display with drop-down menu DMX IN and OUT with 5-pin XLR plugs with waterproof plug POWER IN/OUT with original NEUTRIK PowerCon® TRUE1 connectors Power supply: 100-240V/50-60Hz Power consumption: 129 W Waterproofing level: IP65 Waterproof fan Depressurisation valve with waterproof membrane Finish: cast aluminium painted black Dimensions: 304 x 188 x 272 mm Weight: 4.8 kg

**NEW**



IP65 60W RGBW 25°

**BT-ColoRay 60R**  
LED proj. 60W RGBW 13° RENTAL COB (IP-POWER)

Code : B05510



Optics: 1x 60W RGBW COB LED  
Opening angle: 25°  
Integrated control unit with LCD display with drop-down menu  
DMX IN and OUT with 5-pin XLR plugs with waterproof plug  
POWER IN/OUT with original NEUTRIK PowerCon® TRUE1 connectors  
Power supply: 100-240V/50-60Hz  
Power consumption: 70 W  
Waterproofing level: IP65  
Waterproof fan  
Depressurisation valve with waterproof membrane  
Finish: cast aluminium painted black  
Dimensions: 304 x 188 x 272 mm  
Weight: 4.8 kg

**NEW**



IP65 120W RGBWA 23°

**IPSPOT12x10FIVE**  
Projector with 12x10W - IP65 FIVE LEDs

Code : H10793



Optics: 12x10W RGBWA LED  
Opening angle: 23°  
Integrated control unit with LCD display with drop-down menu  
SEETRONIC® DMX IN and OUT 3- and 5-pin plugs with waterproof plug  
SEETRONIC®POWER IN/OUT 3-pole plugs with waterproof plug  
Power supply: 100-240V/50-60Hz  
Power consumption: 125 W  
Waterproofing level: IP65  
Natural convection cooling  
Depressurisation valve with waterproof membrane  
Finish: cast aluminium painted black  
Dimensions: 261 x 240 x 249 mm  
Weight: 9.9 kg



**NEW**



IP65 70W RGBWA 23°

**IPSPOT7x10FIVE**  
Projector with 7x10W - IP65 FIVE LEDs

Code : H10792



Optics: 7x10W RGBWA LED  
Opening angle: 23°  
Integrated control unit with LCD display with drop-down menu  
SEETRONIC® DMX IN and OUT with 3-pin XLR plugs with waterproof plug  
SEETRONIC®POWER IN/OUT 3-pole plugs with waterproof plug  
Power supply: 100-240V/50-60Hz  
Power consumption: 75 W  
Waterproofing level: IP65  
Natural convection cooling  
Depressurisation valve with waterproof membrane  
Finish: cast aluminium painted black  
Dimensions: 188 x 273 x 282 mm  
Weight: 5.8 kg



Architecture projector connections				
A	H10716	SC3FXX-W - Seetronic female 3P XLR IP65 waterproof plug		SEETRONIC®
B	H10717	SC3MXX-W - Seetronic male 3P XLR IP65 waterproof plug		SEETRONIC®
C	H10718	SC5FXX-W - Seetronic female 5P XLR IP65 waterproof plug		SEETRONIC®
D	H10719	SC5MXX-W - Seetronic male 3P XLR IP65 waterproof plug		SEETRONIC®
E	H10720	SAC3FX - Seetronic Power In XLR IP65 waterproof plug		SEETRONIC®
F	H10721	SAC3MX - Seetronic Power Out IP65 waterproof plug		SEETRONIC®
G	H10722	IPCD-1 - DMX 3P waterproof connection cord - 1m	NEW 2018	HILEC®
	H10723	IPCD-2 - DMX 3P waterproof connection cord - 2m	NEW 2018	HILEC®
	H10724	IPCD-5 - DMX 3P waterproof connection cord - 5m	NEW 2018	HILEC®
H	H10725	IPCP-1 - Waterproof electrical connection cord - 1m	NEW 2018	HILEC®
	H10726	IPCP-2 - Waterproof electrical connection cord - 2m	NEW 2018	HILEC®
	H10776	IPCP-3 - Waterproof electrical connection cord - 3m	NEW 2018	HILEC®
	H10727	IPCP-5 - Waterproof electrical connection cord - 5m	NEW 2018	HILEC®

# ARCHITECTURE PROJECTORS

At a time when new LED sources compete with traditional lamps, surpassing them in many areas, we offer you a new approach to lighting, focused on the quality of diffused light and easy colour control.



**BT-ULTRAZOOM**  
180W RGBW LED projector with 4°-40° motorised zoom (IP65).

Code : B04396



Optics: 1x180W RGBW LED  
Zoom opening angle: 4° to 40°  
Integrated control unit with OLED touch panel display with drop-down menu SEETRONIC® DMX IN and OUT 3- and 5-pin plugs with waterproof plug SEETRONIC®POWER IN/OUT 3-pole plugs with waterproof plug  
Power supply: 100-240V/50-60Hz  
Power consumption: 180W  
Waterproofing level: IP65  
Natural convection cooling  
Depressurisation valve with waterproof membrane  
Finish: cast aluminium painted black  
Dimensions: 250 x 312 x 404 mm  
Weight: 9.15 kg





**BT-SMARTZOOM**  
120W RGBW LED projector with motorized zoom [4° to 36°] (IP65).

Code : B04397

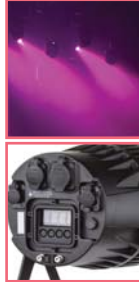

Optics: 1x120W RGBW LED  
Zoom opening angle: 4° to 36°  
Integrated control unit with OLED touch panel display with drop-down menu SEETRONIC® DMX IN and OUT 3- and 5-pin plugs with waterproof plug SEETRONIC®POWER IN/OUT 3-pole plugs with waterproof plug  
Power supply: 100-240V/50-60Hz  
Power consumption: 130W  
Waterproofing level: IP65  
Natural convection cooling  
Depressurisation valve with waterproof membrane  
Finish: cast aluminium painted black  
Dimensions: 274 x 388 x 210 mm  
Weight: 7.7 kg





**PRO BEAMER ZOOM - RENTAL**  
8° - 40° motorised zoom

Code : B04399



Optics: 7x12W RGBW LEDs  
Two zones (outer ring + centre)  
Zoom opening angle: 8° to 40°  
Integrated control unit with display with drop-down menu  
SEETRONIC® DMX IN and OUT with 3-pin XLR plugs with waterproof plug SEETRONIC®POWER IN/OUT 3-pole plugs with waterproof plug  
Power supply: 100-240V/50-60Hz  
Power consumption: 128W  
Waterproofing level: IP66  
Natural convection cooling  
Depressurisation valve with waterproof membrane  
Finish: cast aluminium painted black  
Dimensions: 355 x 191 x 236 mm  
Weight: 7.3 kg



**BARN-PRO BEAMER ZOOM**

Code : B04391



Four-leaf barndoor:  
Compatible with PRO BEAMER ZOOM - RENTAL

**STAGE BEAMER FC - OUTDOOR**  
14x5W RGBW 14° - IP65

Code : B05511



Optics: 14x5W RGBW LEDs  
Opening angle: 14°  
Integrated control unit with display with drop-down menu  
Waterproof wiring for power supply inputs/outputs and DMX inputs/outputs  
Power supply: 100-240V/50-60Hz  
Power consumption: 65W  
Waterproofing level: IP65  
Natural convection cooling  
Finish: cast aluminium painted black  
Dimensions: 245 x 205 x 245 mm  
Weight: 4.96 kg



Find the power and signal cords on the previous page

**NEW**



IP20 14x5W RGBW 14°

**STAGE BEAMER FC – INDOOR**  
LED proj. 14x5W RGBW 14°

Code : B05504



Optics: 14x5W RGBW LEDs  
Opening angle: 14°  
Integrated control unit with display with drop-down menu  
DMX IN / OUT with 3- and 5-pin XLR plugs  
POWER IN/OUT with Powercon plugs  
Power supply: 100-240V/50-60Hz  
Power consumption: 65W  
Natural convection cooling  
Finish: cast aluminium painted black  
Dimensions: 245 x 205 x 245 mm  
Weight: 4.96 kg



**BARN-STAGE BEAMER**  
Stage Beamer barndoor

Code : B04342



Stage beamer four-leaf barndoor





**48x3W RGBW MEGA BEAM**  
Mk3 LED

Code : B04395



IP66 48x3W 15°

**48x3W RGBW MEGA BEAM**  
Mk3 LED

Code : B04395



Optics: 48x3W LEDs  
12 red, 12 green, 12 blue, 12 white  
Opening angle: 15°  
Integrated control unit with display with drop-down menu  
Waterproof wiring for power supply inputs/outputs and DMX inputs/outputs  
Power supply: 100-240V/50-60Hz  
Power consumption: 180W  
Waterproofing level: IP66  
Natural convection cooling  
Finish: cast aluminium painted black  
Dimensions: 305 x 276 x 230 mm  
Weight: 10.3 kg



IP65 7x3W RGB 16°

**MINI BEAMER OUT-DOOR**  
RGB LED 7x3W tricolour LEDs.

Code : B04357



Optics: 7x3W RGB LEDs  
Opening angle: 16°  
Integrated control unit with display with drop-down menu  
Waterproof wiring for power supply inputs/outputs and DMX inputs/outputs  
Power supply: 100-240V/50-60Hz  
Power consumption: 27W  
Waterproofing level: IP65  
Natural convection cooling  
Depressurisation valve with waterproof membrane  
Finish: cast aluminium painted black  
Dimensions: 220 x 175 x 228 mm  
Weight: 5.48 kg







**EZ-SPOT15 OUTDOOR**  
15W RGBW LED projector

Code : B05131





Optics: 1x15W RGBW LED  
Opening angle: 10°  
Infrared remote control IR-3  
Power supply: 100-240V/50-60Hz  
Power consumption: 27W  
Waterproofing level: IP65  
Natural convection cooling  
Finish: cast aluminium painted black  
Dimensions: 152 x 133 x 90 mm  
Weight: 1.31 kg

**EZ-SPOT15 OUTDOOR**  
15W RGBW LED projector

Code : B05131

IP68 1W Blue 10°

**Nano Beam / Blue LED**  
10° LED projector, IP68, 24V (ac/dc)

Code : B04995



Optics: 1x1W Luxeon LED.  
The electrical consumption is only 1.7 W.  
Stainless steel flange.  
Waterproof body (IP68), nickel plated.  
Easy and flexible installation.  
Power supply:  
from 6 to 26 volts (AC)  
from 9 to 35 volts (DC).  
Dimensions: Dia 45 x 82 mm  
Weight: 0.2 kg



# ARCHITECTURE PROJECTORS

Enhance your buildings with all the power of the new CONTEST® IPANELs. Discover the benefit of mixing power with the opening angle.



**NEW**

R G B W

IP65 24x10W RGBW 31°

**IPANEL24x10QC**  
Projector with 24x10W QC IP65 LEDs

---

Code : H10794

---

**Contest®**

**NEW**

**FLY4IPANEL**  
Flight case for 4 IPANEL24x10QC

---

Code : H10866

---

**Contest®**

**NEW**

**IPANEL24x10QC-BARN**  
Leaves for IPANEL24x10QC

---

Code : H10889

---

**Contest®**

Optics: 24x10W RGBW 4-Zone LEDs  
 Opening angle: 31°  
 Integrated control unit with display with drop-down menu  
 DMX mode from 2 to 20 channels, master/slave, manual mode, presets and integrated show, choice of dimmer curves.  
 Waterproof wiring for power supply inputs/outputs and DMX inputs/outputs  
 Power supply: 100-240V/50-60Hz  
 Power consumption: 240 W  
 Waterproofing level: IP65  
 Natural convection cooling  
 Finish: cast aluminium painted black  
 Dimensions: 582 x 270 x 178 mm  
 Weight: 15 kg





RGB IP65 150W COB 60°

**LDP-COBWASH 150TC**  
150W IP65 COB RGB LED

Code : B05170



Optics: 1x150W RGB COB LED  
Opening angle: 60°  
Infrared remote control  
Integrated control unit with display with drop-down menu  
Waterproof wiring for power supply inputs/outputs and DMX inputs/outputs  
Power supply: 100-240V/50-60Hz  
Power consumption: 170W  
Waterproofing level: IP65  
Natural convection cooling  
Finish: cast aluminium, painted white  
Barndoor included  
Dimensions: 326 x 344 x 220 mm  
Weight: 9.5 kg



CW IP65 100W 5600K 60°

**100CW LDP-COBWASH**  
100W white IP65 COB LED projector

Code : B05175



Optics: 1x100W 5600K COB LED  
Opening angle: 60°  
Infrared remote control  
Integrated control unit with display with drop-down menu  
Waterproof wiring for power supply inputs/outputs and DMX inputs/outputs  
Power supply: 100-240V/50-60Hz  
Power consumption: 120 W  
Waterproofing level: IP65  
Natural convection cooling  
Finish: cast aluminium, painted white  
Barndoor included  
Dimensions: 326 x 344 x 220 mm  
Weight: 8.2 kg



WW IP65 100W 3200K 60°

**100WW LDP-COBWASH**  
100W IP65 COB LED projector

Code : B05176



Optics: 1x100W 3200K COB LED  
Opening angle: 60°  
Infrared remote control  
Integrated control unit with display with drop-down menu  
Waterproof wiring for power supply inputs/outputs and DMX inputs/outputs  
Power supply: 100-240V/50-60Hz  
Power consumption: 120 W  
Waterproofing level: IP65  
Natural convection cooling  
Finish: cast aluminium, painted white  
Barndoor included  
Dimensions: 326 x 344 x 220 mm  
Weight: 8.2 kg

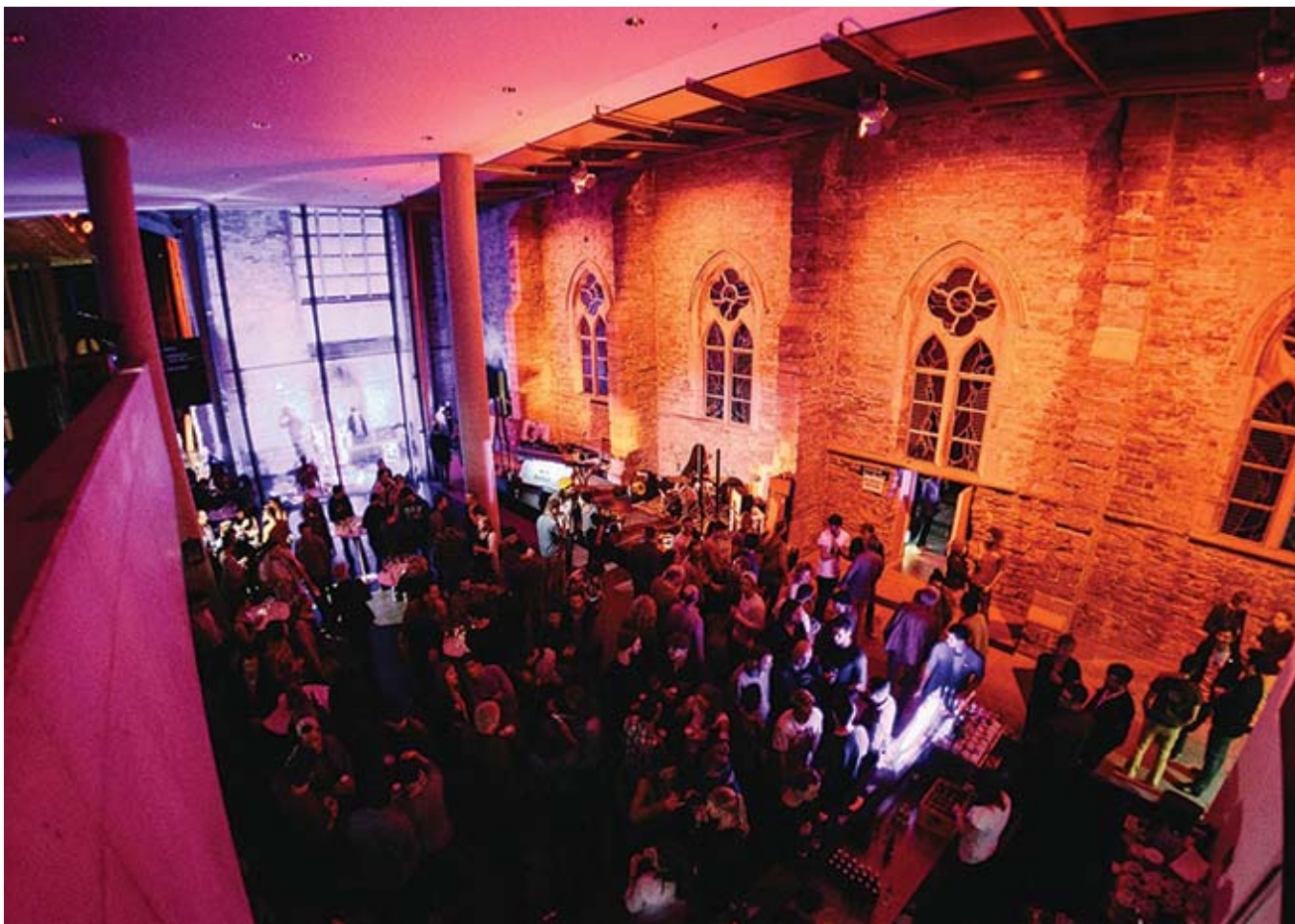

# ARCHITECTURE PROJECTORS



RGB IP65 60W 120°  
RGB

**LDP-COBWASH 60TC**  
60W RGB IP65 COB LED projector

Code : B05171



Optics: 1x 60W RGB COB LED  
Opening angle: 120°  
Infrared remote control  
Integrated control unit with display with drop-down menu  
Waterproof wiring for power supply inputs/outputs and DMX inputs/outputs  
Power supply: 100-240V/50-60Hz  
Power consumption: 66W  
Waterproofing level: IP65  
Natural convection cooling  
Finish: cast aluminium, painted white  
Barndoor option available  
Dimensions: 223 x 202 x 122 mm  
Weight: 8.2 kg



CW IP65 50W 120°  
5600K

**LDP-COBWASH 50CW**  
50W white IP65 COB LED Projector

Code : B05177



Optics: 1x 50W 5600K COB LED  
Opening angle: 120°  
Infrared remote control  
Integrated control unit with display with drop-down menu  
Waterproof wiring for power supply inputs/outputs and DMX inputs/outputs  
Power supply: 100-240V/50-60Hz  
Power consumption: 66W  
Waterproofing level: IP65  
Natural convection cooling  
Finish: cast aluminium, painted white  
Barndoor option available  
Dimensions: 223 x 202 x 122 mm  
Weight: 3.8 kg



WW IP65 50W 120°  
3200K

**LDP-COBWASH 50WW**  
50W white COB IP65 LED projector

Code : B05178



Optics: 1x 50W 3200K COB LED  
Opening angle: 120°  
Infrared remote control  
Integrated control unit with display with drop-down menu  
Waterproof wiring for power supply inputs/outputs and DMX inputs/outputs  
Power supply: 100-240V/50-60Hz  
Power consumption: 66W  
Waterproofing level: IP65  
Natural convection cooling  
Finish: cast aluminium, painted white  
Barndoor option available  
Dimensions: 223 x 202 x 122 mm  
Weight: 3.8 kg



**LDP-COBWASH 50/60 BARNDOOR**

Code : B05191



Barndoor for:  
LDP-COBWASH 50WW  
LDP-COBWASH 50CW  
LDP-COBWASH 60TC.



WW IP65 80W 120°  
3000K

**LDP-FLOOD80-WW**  
IP65 projector with white LED

Code : B05117



Optics: 1x80W 3000K COB LED  
Opening angle: 120°  
Power supply: 100-240V/50-60Hz  
Power consumption: 80W  
Waterproofing level: IP65  
Natural convection cooling  
Finish: cast aluminium, painted white  
Dimensions: 288 x 360 x 110 mm  
Weight: 6.5 kg



WW IP65 50W 120°  
3000K

**LDP-FLOOD50-WW**  
IP65 projector with white LED

Code : B05116



Optics: 1x50W 3000K COB LED  
Opening angle: 120°  
Power supply: 100-240V/50-60Hz  
Power consumption: 50W  
Waterproofing level: IP65  
Natural convection cooling  
Finish: cast aluminium, painted white  
Dimensions: 290 x 236 x 150 mm  
Weight: 3.52 kg



WW IP65 30W 100°  
3000K

**LDP-FLOOD30-WW**  
IP65 projector with white LED

Code : B05115



Optics: 1x30W 300K COB LED  
Opening angle: 100°  
Power supply: 100-240V/50-60Hz  
Power consumption: 30W  
Waterproofing level: IP65  
Natural convection cooling  
Finish: cast aluminium, painted white  
Dimensions: 250 x 185 x 126 mm  
Weight: 2.3 kg



NEW  
WW IP65 10W 120°  
3000K

**LDP-FLOOD10-WW**  
IP65 projector with white LED

Code : B05114



Optics: 1x10W Bridgelux® LED  
Opening angle: 120°  
Power supply: 100-240V/50-60Hz  
Power consumption: 10W  
Waterproofing level: IP65  
Natural convection cooling  
Finish: cast aluminium, painted white  
Dimensions: 115 x 86 x 105 mm  
Weight: 0.63 kg





**IP20**
**96W**  
 RGBW

**LDP-COLORSTRIP 24FC**

Bar with 24x4W RGBW 25° 4-section LEDs - 100cm - IP20

Code : B05144



Optics: 24x4W RGBW 4-section LEDs  
 Opening angle: 15°  
 Integrated control unit with display with drop-down menu  
 Power supply input/output on IEC plug  
 DMX input/output on XLR 3-pin plug  
 Power supply: 100-240V/50-60Hz  
 Power consumption: 85 W  
 Waterproofing level: IP20  
 Natural convection cooling  
 Dimensions: 961 x 56 x 101/122 mm  
 Weight: 3.6 kg



**IP20**
**48W**  
 RGBW

**LDP-COLORSTRIP 12FC**

Bar with 12x4W RGBW 15° 2-section LEDs - 50cm - IP20

Code : B05143



Optics: 12x4W RGBW 2-section LEDs  
 Opening angle: 15°  
 Integrated control unit with display with drop-down menu  
 Power supply input/output on IEC plug  
 DMX input/output on XLR 3-pin plug  
 Power supply: 100-240V/50-60Hz  
 Power consumption: 56 W  
 Waterproofing level: IP20  
 Natural convection cooling  
 Dimensions: 479 x 56 x 101/122 mm  
 Weight: 2.2 kg

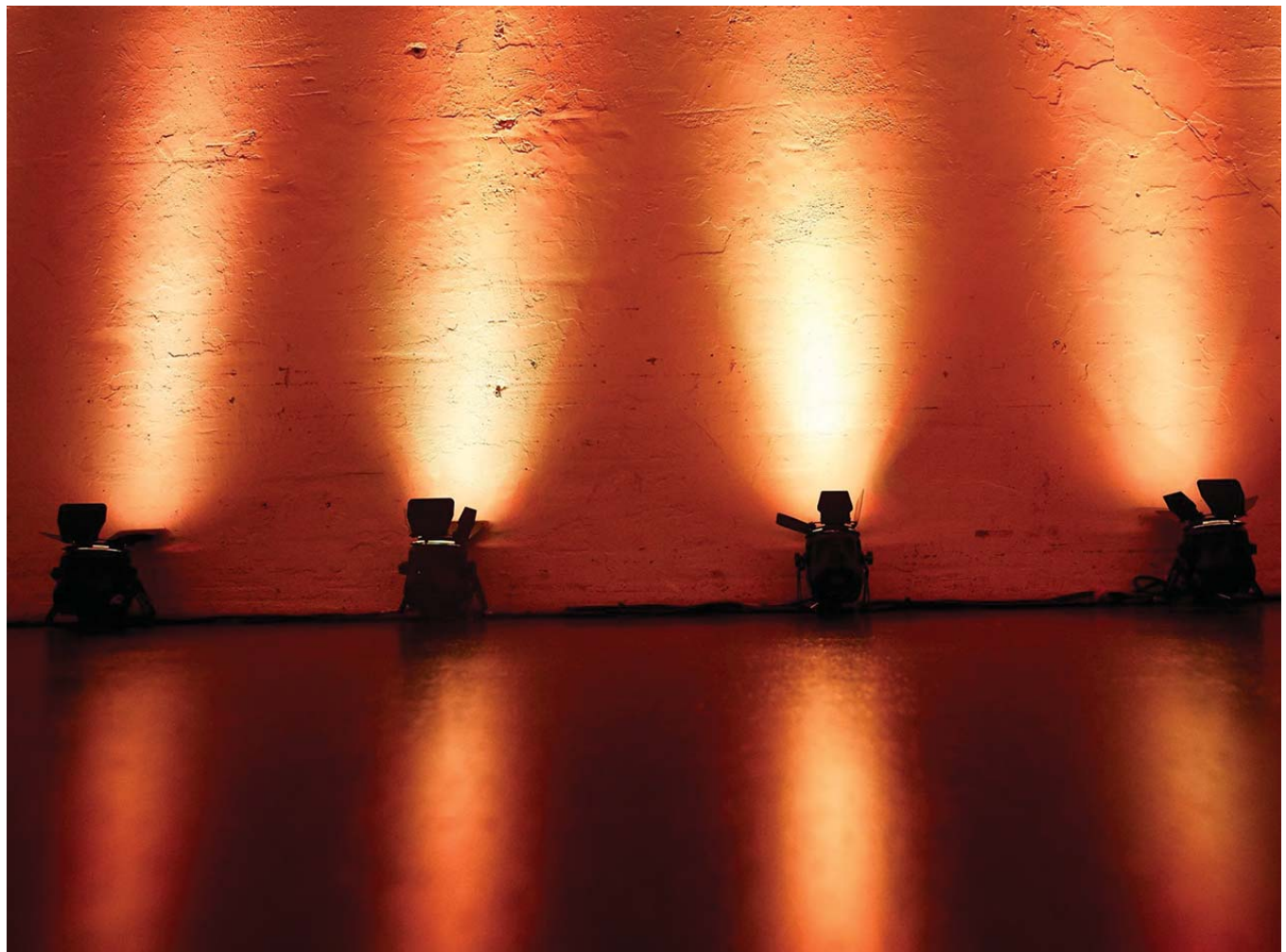

# ARCHITECTURE PROJECTORS



**NEW**



**IP65**

**48W**  
 RGBW

**15°**

**LDP-POWERBAR 12FC**  
 LED projectors 12x4W RGBW IP65 LEDs.  
 Bar length 48 cm

Code : B05134



**NEW**





**IP65**

**96W**  
 RGBW

**15°**

**LDP-POWERBAR 24FC**  
 IP65 LED projector. 24x4W RGBW LEDs. Bar length 96 cm

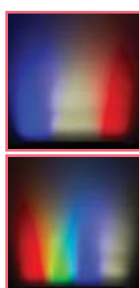
Code : B05132

**LDP-JUNCTION IP68**  
 Waterproof connection box for the LDP series and other outdoor DMX projectors.

Code : B05112



Optics: 12x4W RGBW LEDs  
 Opening angle: 15°  
 Integrated control unit with OLED display and backlit touch buttons  
 Waterproof wiring for power supply inputs/outputs and DMX inputs/outputs  
 Power supply: 100-240V/50-60Hz  
 Power consumption: 56W  
 Waterproofing level: IP65  
 Natural convection cooling  
 Depressurisation valve with waterproof membrane  
 Finish: cast aluminium painted white  
 Dimensions: 480 x 56 x 13.5 mm  
 Weight: 3 kg

Optics: 24x4W RGBW LEDs  
 Opening angle: 15°  
 Integrated control unit with OLED display and backlit touch buttons  
 Waterproof wiring for power supply inputs/outputs and DMX inputs/outputs  
 Power supply: 100-240V/50-60Hz  
 Power consumption: 85W  
 Waterproofing level: IP65  
 Natural convection cooling  
 Depressurisation valve with waterproof membrane  
 Finish: cast aluminium painted white  
 Dimensions: 960 x 56 x 13.5 mm  
 Weight: 5.02 kg

Waterproof connection box for the LDP series and other outdoor DMX projectors. IP68 protection: Outdoor or even underground use.  
 Power supply compartment with 3 input outlets  
 DMX compartment with 4 input outlets  
 Very easy and fast internal connection  
 Ideal for the LDP series and any other combination of outdoor power/signal (PowerBeam lighting, LED Blaster, Powerbank, ...)



Light Integration Accessories			
<b>A</b>	B04911	POWERLINK CABLE 1.5 m - Powerlink Cable 1.5M for Outdoor range	HILEC®
<b>B</b>	B04913	POWERLINK CABLE 10m - Powerlink Cable 10m, for Outdoor range	HILEC®
<b>C</b>	B04324	POWERLINK CABLE 5m - Powerlink Cable 5m, for Outdoor range	HILEC®
<b>D</b>	B04908	SIGNAL LINK CABLE 1.5M - Signal Link Cable 1.5m for Outdoor range	HILEC®
<b>E</b>	B04904	SIGNAL LINK CABLE 1.5M - Signal Link Cable 1.5m for Outdoor range	HILEC®
<b>F</b>	B04903	SIGNAL LINK CABLE 5M - Signal Link Cable 5m, for Outdoor range	HILEC®
<b>G</b>	B05157	LDP-Powercable 2M - Power cable L=2m for LDP-POWERBAR, COBWA	HILEC®
<b>H</b>	B05158	LDP-Powercable 5M - Power cable L=5m for LDP-POWERBAR, COBWA	HILEC®

# AMBIENT PROJECTORS



IP20 12x3W RGB 25°

## TRI4U

Light bar with 4x3W LED tricolour projectors

Code : H9955

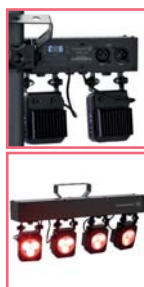

IP20 12x1W RGB 30°

## MINIBAR

Mini bar with 12x1W RGB LEDs

Code : H10022

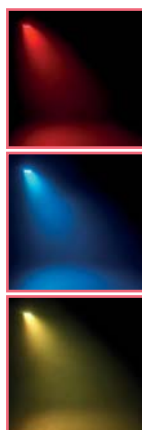

IP20 6x3W RGB 30°

## MINITRUSS-6TCb

Structure decoration projector with 6x3W TRI LEDs

Code : H10365



12x3W RGB LEDs located on 4 projectors  
Opening angle: 25° per projector  
Independent orientation per projector  
Modes of operation:  
- DMX  
- Standalone  
- Musical  
- Master / slave  
Specially designed hanging bracket with integrated hook for stand  
Dimensions: 375 x 160 x 60 mm  
Net weight: 2.5 Kg

Light source: 12x1W LEDs  
LED: 4x Red + 4x Green + 4x Blue  
Opening angle: 30°  
Modes of operation:  
- DMX  
- Standalone  
- Musical  
- Master / slave  
Power supply: 230V - 50Hz  
Power consumption: 20W  
Dimensions: 295 x 78 x 110 mm  
Net weight: 1.5 kg

Light source: 6x3W RGB LEDs  
Opening angle: 30°  
Modes of operation:  
- DMX  
- Standalone  
- Musical  
- Master / slave  
Input/output on IEC plug  
Power supply: 230V - 50Hz  
Power consumption: 30W  
Dimensions: 135 x 135 x 132 mm  
Net weight: 1.4 kg

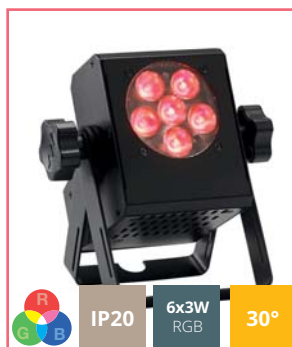

IP20 6x3W RGB 30°

## MINICUBE-6TCb

Compact projectors with 6x3W satin TRINoIR LEDs

Code : H10147



IP20 60W 18°

## LED ROTOGOBO

60W gobos LED projector

Code : B04528



IP20 10W

## Artist10W

10W gobo LED projector

Code : H10651



Light source: 6x3W RGB LEDs  
Opening angle: 30°  
Modes of operation:  
- DMX  
- Standalone  
- Musical  
- Master / slave  
DMX input and output  
Power supply: AC 100/240V - 50/60Hz  
Power consumption: 30 W  
Dimensions: 166 x 180 x 110 mm  
Net weight: 1.35 kg

A powerful 60W white LED motif projector  
Low gobo temperature: no need for expensive thermo-resistant glass or metal gobos!  
Usable with plastic gobos created by a simple laser printer!  
Metal and glass gobos are of course always usable.  
Easy adjustment by rotary knobs on the back of the projector:  
Rotation speed control of the gobo  
Dimmer switch to adjust light intensity  
Beam angle: 18°  
Dimensions: 236 x 234 x 206 mm  
Weight: 3.4 kg

1x10W white LED  
Adjustment of rotation speed  
Power, stop and auto off timer button  
Power consumption: 12W maximum  
Power supply: AC 100/240V - 50/60Hz with 12V DC adapter provided  
Water resistant plastic case  
Suspension moving head, table support cup and floor mounting pin  
Dimensions: 170 x 140 x 240 mm  
Weight: 0.700 kg



# BATTERY PROJECTORS



**IP65** **5x12W** RGBWAUV **25°**

**IPair5x12Six**  
IP65 AirDMX battery projector

Code : H10411



Optics: 5x12W RGBWAUV LEDs  
Opening angle: 25°  
AirDMX integrated transmitter / receiver  
Compatible with AirBox-ER1  
Integrated control unit with display with drop-down menu  
Infrared remote control  
DMX IN and OUT with 3-pin IP plugs  
POWER IN/OUT with 4-pin IP plugs  
Power supply: 100-240V/50-60Hz



**FLY-IPairx6**  
Flight case for 6 IPair5x12Six

Code : H10464



Power consumption: 65 W  
12-cell 22.2V 4.4Ah lithium battery  
Battery life: 6 hours in color changing mode - 4 hours in white [RGB]  
Waterproofing level: IP65  
Finish: cast aluminium painted black  
Dimensions: 240 x 165 x 280 mm  
Weight: 3.5 kg



<b>A</b>	H10465	FICIP-DMXm - DMX male waterproof plug for IPAir- IP68
<b>B</b>	H10466	FICIP-DMXF - DMX female waterproof plug for IPAir- IP68
<b>C</b>	H10467	FICIP-POWm - Male waterproof power plug for IPAir- IP68
<b>D</b>	H10468	FICIP-POWf - Female waterproof power plug for IPAir- IP68



**NEW**



**IP65** **6x10W** RGBWA **25°**

**BT-AKKULITE IP**  
Outdoor 6x10W RGBWA 5in1 LED projector + infrared remote control

Code : B05135



Optics: 6x10W RGBWA LEDs  
Opening angle: 22°  
Wireless transmitter / receiver compatible with protocol W-DMX G4  
Integrated control unit with display with drop-down menu  
Infrared remote control  
DMX IN / OUT with 3-pin XLR,  
POWER IN by Pro Con (Seetronic)  
Waterproofing level: IP65  
Power supply: 100-240V/50-60Hz Battery  
Power consumption: 60 W  
Dimensions: 180 x 150 x 198 mm  
Weight: 4.5 kg



**IP20** **6x10W** RGBWA **22°**

**ACCU COLOR-WHITE**  
Battery powered LED projector, built around 6 RGBWA (10W) LEDs

Code : B05126



Optics: 6x10W RGBWA LEDs  
Opening angle: 22°  
Wireless transmitter / receiver compatible with protocol W-DMX G4  
Integrated control unit with display with drop-down menu  
Infrared remote control  
DMX IN and OUT with 3-pin XLR,  
POWER IN/OUT with Powercon  
Power supply: 100-240V/50-60Hz Battery  
Power consumption: 60 W  
Finish: white  
delivered with a transparent plastic cover  
Dimensions: 167 x 138 x 185 mm  
Weight: 4.14 kg



**IP20** **6x10W** RGBWA **22°**

**ACCU COLOR-BLACK**  
Battery powered LED projector, built around 6 RGBWA (10W) LEDs

Code : B05128



Optics: 6x10W RGBWA LEDs  
Opening angle: 22°  
Wireless transmitter / receiver compatible with protocol W-DMX G4  
Integrated control unit with display with drop-down menu  
Infrared remote control  
DMX IN and OUT with 3-pin XLR,  
POWER IN/OUT with Powercon  
Power supply: 100-240V/50-60Hz Battery  
Power consumption: 60 W  
Finish: black  
delivered with a transparent plastic cover  
Dimensions: 167 x 138 x 185 mm  
Weight: 4.14 kg





**CASE-2 for 6x ACCU COLOR**

6x ACCU COLOR projectors + accessories

Code : B03268

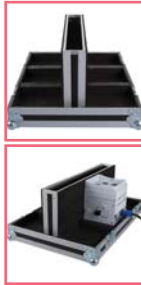

**IP20**
**15W RGBW**
**30°**

**ACCU DECOLITE**

A battery powered LED projector, built around RGB + White 15W LED, with embedded wireless DMX

Code : B05127



**NEW**
**IP65**
**15W RGBW**
**10°**

**ACCU DECOLITE IP**

A battery powered IP65 LED projector, built around 15W RGB + White LED, with embedded wireless DMX

Code : B05136



Flight case for 6x ACCU COLOR or 6x BT-AKKULITE projectors and accessories

Optics: 1x15W RGBW LED  
 Opening angle: 10 to 25°  
 Wireless transmitter / receiver compatible with protocol W-DMX G4  
 Integrated control unit with display with drop-down menu  
 Infrared remote control  
 Power supply: 100-240V/50-60Hz Battery  
 Power consumption: 15 W  
 Dimensions: 168 x 138 x 62 mm  
 Weight: 1.61 kg

Optics: 1x15W RGBW LED  
 Opening angle: 10°  
 Wireless transmitter / receiver compatible with protocol W-DMX G4  
 Integrated control unit with display with drop-down menu  
 Infrared remote control  
 Power supply: 100-240V/50-60Hz  
 Power consumption: 15 W  
 Dimensions: 172 x 138 x 185 mm  
 Weight: 1.61 kg



**NEW**  
**ACCU DECOLITE IP TUBE 50CM**

50cm acrylic tube for Accu Decolite IP

Code : B05137



**NEW**  
**100CM ACCU DECOLITE IP TUBE**

100cm acrylic tube for Accu Decolite IP

Code : B05138



**NEW**  
**150CM ACCU DECOLITE IP TUBE**

150cm acrylic tube for Accu Decolite IP

Code : B05139

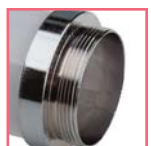

# SCENOGRAPHY PROJECTORS

---

"The scenographer is the one who composes with volumes, objects, colours, lights and textures".

This term "scenographer" consists of three major categories:

- The scenographer of a show who puts on a show or a particular event.
- The scenographer of equipment who designs a place intended to host live shows or various events.
- The scenographer of exhibitions who intervenes in the field of museums and exhibitions.



## EQUIPMENT FOR PERMANENT OR TEMPORARY EXHIBITION

A high performance, a very long life and low power consumption allow the LED source to integrate compact, aesthetic and efficient projectors.

They will enhance all kinds of places and surfaces while respecting the subjects lit.

## STAGE EQUIPMENT FOR LIVE PERFORMANCE

Economical in energy and easy to install, the products of the ScenoGraFX range are ideal lighting solutions for the optimisation of all your events

The projectors in the range offer lighting quality and dimming that are identical to filament lamps thanks to the different built-in dimmer modes.

## LED LIGHT SOURCES

The LED light sources provide new solutions in many areas. Currently, LEDs are used for theatrical, architectural and event lighting.

Building on the success of their range of animation projectors, Contest® and Briteq® develop this technology with the creation of a new range of projectors designed to produce exceptional brightness with great optical and ergonomic quality.



CW 370W  
6500K 20°

**EXPO CANNON**  
370 W cool white CREE LED projector

Code : B05133



WW 150W  
3200K 90°  
x113°

**SFX-H0150W**  
150W warm white asymmetrical floodlight type COB LED projector

Code : H10702

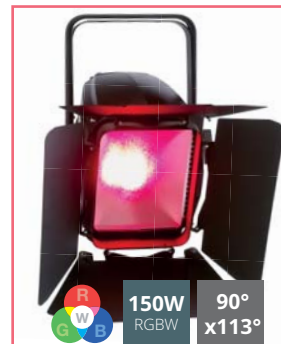

150W  
RGBW 90°  
x113°

**SFX-H0150QC**  
150W RGBW asymmetrical floodlight type COB LED projector

Code : H10701

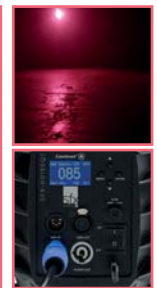

Optics: 37x10W 6500K CREE LED  
Opening angle: 20°  
Brightness of 26953 Lux at 4m  
Integrated control unit with OLED LCD Display with drop-down menu  
DMX IN / OUT with XLR 3-pin plugs,  
POWER IN/OUT with NEUTRIK powerCON®  
Power supply: 100-240V/50-60Hz  
Power consumption: 380 W heat sink and silent fan.  
Finish: Black extruded aluminium  
Frost filter and barndoor included  
Dimensions: 295 x 315 x 377 mm  
Weight: 6.2 kg

Optics: 1x150W 3200K COB LED  
Opening angle: 90°x113°  
Brightness of 530 Lux at 4m  
Integrated control unit with LCD display with drop-down menu  
DMX IN / OUT with XLR 3-pin plugs,  
POWER IN/OUT with powerCON plugs  
Power supply: 100-240V/50-60Hz  
Power consumption: 155 W heat sink and silent fan.  
Finish: Black  
Delivered with barndoor, filter frame  
Dimensions: 295 x 315 x 377 mm  
Weight: 6.2 kg

Optics: 1x150W RGBW COB LED  
Opening angle: 90°x113°  
Brightness of 289 Lux at 4m  
Integrated control unit with LCD display with drop-down menu  
DMX IN / OUT with XLR 3-pin plugs,  
POWER IN/OUT with powerCON plugs  
Power supply: 100-240V/50-60Hz  
Power consumption: 155 W heat sink and silent fan.  
Finish: Black  
Delivered with barndoor, filter frame  
Dimensions: 295 x 315 x 377 mm  
Weight: 6.2 kg



WW 100W  
3200K 10°  
50°

**BT-THEATRE 100EC Mk2**  
LED with 10° to 50° manual zoom

Code : B06008



WW 100W  
3200K 10°  
50°

**BT-THEATRE 100EC WHITE**  
LED with 10° to 50° manual zoom

Code : B06012

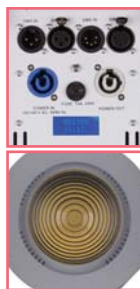

WW 250W  
3200K 15°  
50°

**BT-THEATRE 250EZ**  
Powerful LED theatre projector with 10° - 50° electronic zoom

Code : B06016



Optics: 1x100W 3200K COB LED  
manual zoom: 10° to 50°  
7800 lux @ 2m (beam angle: 10°)  
Integrated control unit with LCD display with drop-down menu  
DMX IN/OUT with 3/5-pin XLR plugs  
POWER IN/OUT with powerCON plugs  
Power supply: 100-240V/50-60Hz  
Power consumption: 125 W  
Silent fan (31dB@1m)  
Finish: Black  
Delivered with barndoor, filter frame  
Dimensions: 2788 x 305 x 336 mm  
Weight: 6.2 kg

Optics: 1x100W 3200K COB LED  
manual zoom: 10° to 50°  
7800 lux @ 2m (beam angle: 10°)  
Integrated control unit with LCD display with drop-down menu  
DMX IN/OUT with 3/5-pin XLR plugs  
POWER IN/OUT with powerCON plugs  
Power supply: 100-240V/50-60Hz  
Power consumption: 125 W  
Silent fan (31dB@1m)  
Finish: white  
Delivered with barndoor, filter frame  
Dimensions: 2788 x 305 x 336 mm  
Weight: 6.2 kg

Optics: 1x250W 3200K COB LED  
Opening zoom angle: 15° to 50°  
Brightness of 1500 to 7735 Lux at 4m  
Direct access to the dimmer and zoom  
Integrated control unit with LCD display with drop-down menu  
DMX IN/OUT with 3/5-pin XLR plugs  
POWER IN/OUT with powerCON plugs  
Power supply: 100-240V/50-60Hz  
Power consumption: 275 W heat sink and silent fan.  
Finish: Black  
Delivered with barndoor, filter frame  
Dimensions: 458 x 336 x 399 mm  
Weight: 8.9 kg



# SCENOGRAPHY PROJECTORS



**SFX-FR250W**  
Fresnel warm white 250W COB LED projector with motorized zoom

Code : H10707



Optics: 1x 250W 3200K COB LED  
Opening zoom angle: 15° to 45°  
Brightness of 2280 to 7900 Lux at 4m  
Direct access to the dimmer and zoom  
Integrated control unit with LCD display with drop-down menu  
DMX IN/OUT with 3/5-pin XLR plugs  
POWER IN/OUT with powerCON plugs  
Power supply: 100-240V/50-60Hz  
Power consumption: 275 W heat sink and silent fan.  
Finish: Black  
Delivered with barndoor filter frame  
Dimensions: 458 x 336 x 399 mm  
Weight: 8.9 kg



**SFX-FR150W**  
Fresnel warm white 150W COB LED projector with motorized zoom

Code : H10708



Optics: 1x 150W 3200K COB LED  
Opening zoom angle: 15° to 45°  
Brightness of 1242 to 6540 Lux at 4m  
Direct access to the dimmer and zoom  
Integrated control unit with LCD display with drop-down menu  
DMX IN/OUT with 3/5-pin XLR plugs  
POWER IN/OUT with powerCON plugs  
Power supply: 100-240V/50-60Hz  
Power consumption: 175 W heat sink and silent fan.  
Finish: Black  
Delivered with barndoor filter frame  
Dimensions: 458 x 336 x 399 mm  
Weight: 8.9 kg



**SFX-PC60QCb**  
60W RGBW COB 4-in-1 LED with manual zoom and black finish

Code : H10705



Optics: 1x 60W RGBW COB LED  
manual zoom: 20° to 45°  
Brightness of 250 to 1870 Lux at 3m  
Integrated control unit with LCD display with drop-down menu  
DMX IN/OUT with 3-pin XLR plugs  
POWER IN with powerCON plugs  
Power supply: 100-240V/50-60Hz  
Power consumption: 70 W  
Dissipation fan  
Finish: Black  
Delivered with barndoor filter frame  
Dimensions: 241 x 196 x 173 mm  
Weight: 3.6 kg



**SFX-GOR050W**  
50W LED projector with zoom and rotating gobo

Code : H10848



50W COB LED gobo projector  
Brightness of 2840 Lux at 3m at 15°  
Opening of 15° to 30°  
Manual focus of the lens and opening  
Infrared remote control  
Rotary gobo holder (outer diam. 25.8 mm, image 19 mm)  
4 gobos included  
DMX IN/OUT with 3-pin XLR plugs  
POWER IN/OUT with Powercon  
Silent ventilation  
USB port for WTR-DMX (option)  
Power supply: 100-240V/50-60Hz  
Dimensions: 315 x 175 x 266 mm  
Power consumption: 53 W  
Finish: black  
Weight: 2.8 kg

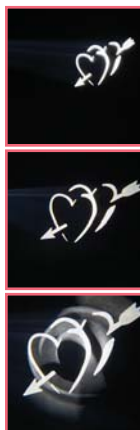

**SFX-B15QC**  
15W 4° QC LED beam projector with remote control

Code : H10831



Optics: 1x15W RBGW COB LED  
Opening angle: 4° (10, 30 and 50° frost)  
Brightness of 5070 Lux at 3m  
Infrared remote control  
Ready for a DMX wireless connection with the WTR-DMX option  
1-8 channel DMX, fixed colours, Step or Fade programs, Auto mode with sound sensitivity, Slave Mode  
LCD display with drop-down menu  
DMX IN/OUT with 3-pin XLR plugs  
POWER IN/OUT with Powercon  
Power supply: 100-240V/50-60Hz  
Power consumption: 62 W  
Forced fan  
Finish: black  
Dimensions: 220 x 147 x 191 mm  
Weight: 1.8 kg

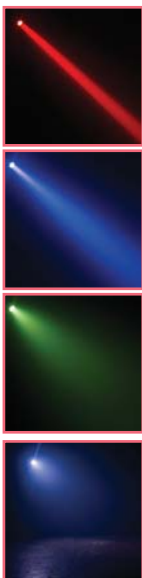

OPTIONAL:

**WTR-DMX DONGLE**  
(code B04645)

The perfect solution for all those who seek wireless DMX

Compatible with:

**SFX-GOR050W, SFX-B15QC**  
and **SFX-DE50W**



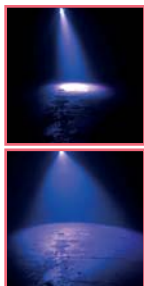

60W RGBW 20° 45°

**SFX-PC60QCw**  
60W COB 4-in-1 RGBW LED plano-convex projector with manual zoom White finish

Code : H10706



Optics: 1x 60W RGBW COB LED  
manual zoom: 20° to 45°  
Brightness of 250 to 1870 Lux at 3m  
Integrated control unit with LCD display with drop-down menu  
DMX IN/OUT with 3-pin XLR plugs  
POWER IN with powerCON plugs  
Power supply: 100-240V/50-60Hz  
Power consumption: 70 W  
Dissipation fan  
Finish: white  
Delivered with barndoor filter frame  
Dimensions: 241 x 196 x 173 mm  
Weight: 3.6 kg



WW 50W 3200K 20° 45°

**SFX-PC50Wb**  
50W COB warm white LED plano-convex projector with manual zoom Black finish

Code : H10703



Optics: 1x50W 3200K COB LED  
manual zoom: 20° to 45°  
Brightness of 440 to 2200 Lux at 3m  
Integrated control unit with LCD display with drop-down menu  
DMX IN/OUT with 3-pin XLR plugs  
POWER IN with powerCON plugs  
Power supply: 100-240V/50-60Hz  
Power consumption: 55 W  
Dissipation fan  
Finish: black  
Delivered with barndoor filter frame  
Dimensions: 241 x 196 x 173 mm  
Weight: 3.6 kg



WW 50W 3200K 20° 45°

**SFX-PC50Ww**  
50W COB warm white LED plano-convex projector with manual zoom Black finish

Code : H10704



Optics: 1x50W 3200K COB LED  
manual zoom: 20° to 45°  
Brightness of 440 to 2200 Lux at 3m  
Integrated control unit with LCD display with drop-down menu  
DMX IN/OUT with 3-pin XLR plugs  
POWER IN with powerCON plugs  
Power supply: 100-240V/50-60Hz  
Power consumption: 55 W  
Dissipation fan  
Finish: white  
Delivered with barndoor filter frame  
Dimensions: 241 x 196 x 173 mm  
Weight: 3.6 kg



60W RGBW 10° 50°

**BT-THEATRE 60FC**  
60W RGBW COB LED with 10° - 50° manual zoom.

Code : B06015



Optics: 1x 60W RGBW COB LED  
manual zoom: 10° to 50°  
330 lux at 5m and 10°, 77 lux at 5m and 40°  
Integrated control unit with LCD display with drop-down menu  
DMX IN/OUT with 3-pin XLR plugs  
POWER IN with 1 m cord with plug  
Power supply: 100-240V/50-60Hz  
Power consumption: 62 W  
Dissipation fan  
Finish: black  
Delivered with barndoor filter frame  
Dimensions: 241 x 196 x 173 mm  
Weight: 3.6 kg



WW 50W 3200K 10° 50°

**BT-THEATRE 50WW**  
LED with 10° - 50° manual zoom. 50W warm white LED

Code : B06013



Optics: 1x50W 3200K COB LED  
manual zoom: 10° to 50°  
330 lux at 5m and 10°, 77 lux at 5m and 40°  
Integrated control unit with LCD display with drop-down menu  
DMX IN/OUT with 3-pin XLR plugs  
POWER IN with 1 m cord with plug  
Power supply: 100-240V/50-60Hz  
Power consumption: 55 W  
Dissipation fan  
Finish: black  
Delivered with barndoor filter frame  
Dimensions: 241 x 196 x 173 mm  
Weight: 3.6 kg



WW 50W 3200K 10° 50°

**BT-THEATRE 50WW**  
10° - 50° manual zoom LED. 50W warm white LED

Code : B06014



Optics: 1x50W 3200K COB LED  
manual zoom: 10° to 50°  
330 lux at 5m and 10°, 77 lux at 5m and 40°  
Integrated control unit with LCD display with drop-down menu  
DMX IN/OUT with 3-pin XLR plugs  
POWER IN with 1 m cord with plug  
Power supply: 100-240V/50-60Hz  
Power consumption: 55 W  
Dissipation fan  
Finish: white  
Delivered with barndoor filter frame  
Dimensions: 241 x 196 x 173 mm  
Weight: 3.6 kg



# SCENOGRAPHY PROJECTORS



WW 160W  
3200K



## BT-PROFILE160/ LED ENGINE

160W COB LED cutout

Code : B06000



High power COB LED profile spot  
Optics: 1x160W 3200K COB LED  
11566 Lumen  
Compatible with ETC "Source Four" optics  
Integrated control unit with LCD display  
DMX IN/OUT with 3-pin XLR plugs  
POWER IN with power cord without plug  
Power supply: 100-240V/50-60Hz  
Power consumption: 170 W  
Extremely silent cooling system using  
heat pipe technology  
Finish: black  
Weight: 6.1 kg  
Option:  
BT-PROFILE160/OPTIC 15-30  
BT-PROFILE160/OPTIC 25-50



15°  
30°

## BT-PROFILE160/OP- TIC 15-30

Code : B06001



Optical elements with special coating for  
clear and well-defined projections  
Four contoured, specially coated blades  
for minimal reflections  
BT-PROFILE160/OPTIC 15-30  
15°-30° zoom range  
Lockable compartment for the use of  
available options:  
BT-PROFILE160/GOBO HOLDERIRIS  
BT-PROFILE160/IRIS  
Using zoom/focus combined with lock-  
ing mechanism  
BT-PROFILE160/LED ENGINE This is the  
active part. Equipped with a 160W COB  
LED, it is sold separately.



25°  
50°

## BT-PROFILE160/OP- TIC 25-50

Code : B06002



Optical elements with special coating for  
clear and well-defined projections  
Four contoured, specially coated blades  
for minimal reflections  
BT-PROFILE160/OPTIC 25-50  
25°-50° zoom range  
Lockable compartment for the use of  
available options:  
BT-PROFILE160/GOBO HOLDERIRIS  
BT-PROFILE160/IRIS  
Using zoom/focus combined with lock-  
ing mechanism  
BT-PROFILE160/LED ENGINE This is the  
active part. Equipped with a 160W COB  
LED, it is sold separately.



## BT-PROFILE160/ GOBO HOLDER

GOBO door for BT-PROFILE160/OPTIC

Code : B06003



GOBO holder for BT-PROFILE160/OPTIC  
Outer diameter of the gobos: 86mm,  
Optical diameter: 64.5mm



## BT-PROFILE160/IRIS

Irises for BT-PROFILE160/OPTIC

Code : B06004



Irises for BT-PROFILE160/OPTIC  
Opening diameter: adjustable from 5 to  
74 mm

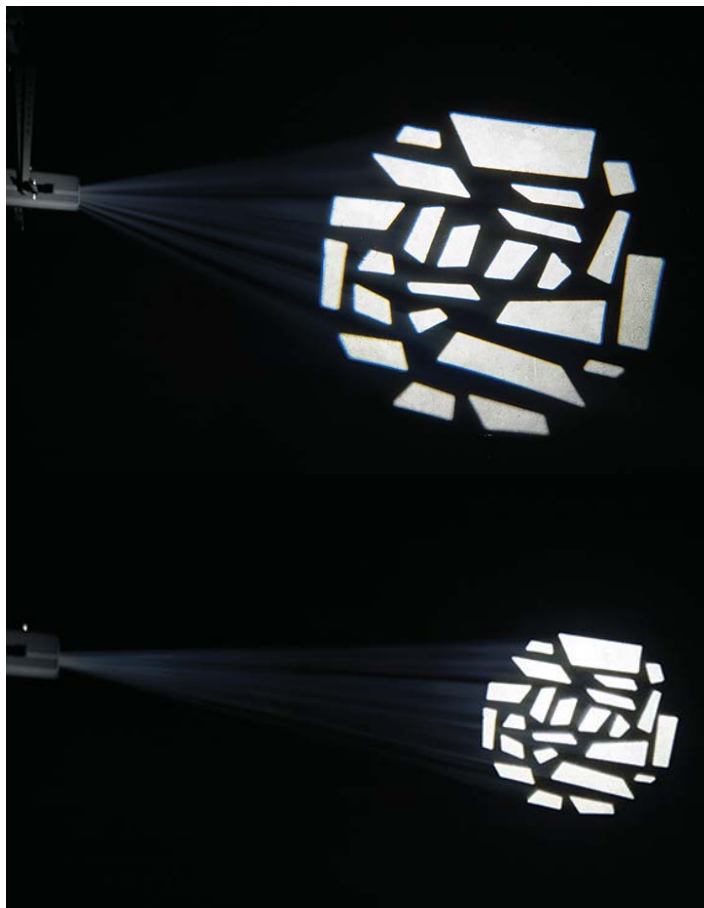



WW 10W  
3200K

**BT-MINIPROFILE  
3200K LED**

Mini LED-profiled projector

Code : B06009

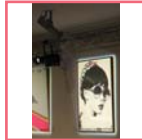

19°

**BT-MINIPROFILE  
OPTIC 19deg**

Optional lens 19°

Code : B06010

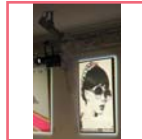

26°

**BT-MINIPROFILE  
OPTIC 26deg**

Optional lens 26°

Code : B06011

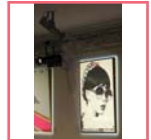

Mini 10W 3200K LED-profile projector  
Variation in intensity: using 230V power block or 0-10V voltage.  
Power supply: 100-240V/50-60Hz  
Dissipation fan  
Finish: black  
Dimensions: 290 x 107 x 236 mm  
Weight: 1.25 kg



15°  
30°

**BT-MINIPROFILE  
OPTIC ZOOM**

19°-36° zoom

Code : B06017



40W  
3200K

**SFX-DE40W**

40W white LED profile projector with gobo holder

Code : H10700

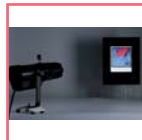

NW 50W  
4000K 15°  
30°

**SFX-DE50W**

50W DMX LED profile with gobo holder and 10-30° zoom

Code : H10836

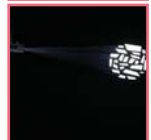



19°-36° optional zoom for BT-MINI-PROFILE.

40W 3200K COB LED profile spot  
Brightness of 1150 Lux at 3m  
Opening of 19°  
Beam modulation blades  
Electronic dimmer  
Manual lens focusing  
Gobo holder (outer diameter 34mm, image 24mm) 2 gobos included  
POWER IN with power cord with plug  
Convection fan  
Power supply: 100-240V/50-60Hz  
Dimensions: 273 x 111 x 100 mm  
Power consumption: 40 W  
Finish: black  
Weight: 1.2 kg

50W COB LED profile spot  
Brightness of 2840 Lux at 3m at 15°  
Opening of 15° to 30°  
Beam modulation blades  
Manual focus of the lens and opening  
Infrared remote control  
Gobo holder (outer diam. 25.8mm, image 19mm), 4 gobos included  
DMX IN / OUT with 3-pin plugs  
POWER IN / OUT with Powercon  
Silent ventilation  
USB port for WTR-DMX (option)  
Power supply: 100-240V/50-60Hz  
Dimensions: 500 x 150 x 100 mm  
Power consumption: 53 W  
Finish: black  
Weight: 3 kg

# FLAT PROJECTORS



**irLDFLAT**  
**12x12SIXb**  
 12x12W six-colour LEDs

Code : H10143

**Contest** 

12x12W six-colour RGBWA + UV LEDs  
 Beam opening: 40°  
 Light intensity: 1400 Lux at 3 m  
 Infrared remote control  
 Digital display with drop-down menu  
 Input and output on IEC plugs  
 Modes of operation:  
 2-9 channel DMX, fixed colours, Step or Fade programs, Auto mode with sound sensitivity, Slave Mode, Editing and playback of a 20-step program  
 Power consumption: 160 W  
 Power supply: AC 100/240V - 50/60Hz  
 DMX input and output  
 Dimensions: 275 x 310 x 110 mm  
 Net weight: 3.4 kg











**irLEDFLAT**  
**12x12IfXb-Air**  
 12 six-colour LEDs with wireless DMX

Code : H10526

**Contest** 

12x12W six-colour RGBWA + UV LEDs  
 Beam opening: 40°  
 Light intensity: 1400 Lux at 3 m  
 Wireless airDMX embedded transmitter and receiver. 2.4-GHz frequency band  
 Compatible with AirBox-ER1  
 Infrared remote control  
 Digital display with drop-down menu  
 Input and output on IEC plugs  
 Modes of operation:  
 2-9 channel DMX, fixed colours, Step or Fade programs, Auto mode with sound sensitivity, Slave Mode, EEditing and playback of a 20-step program  
 Power consumption: 160 W  
 Power supply: AC 100/240V - 50/60Hz  
 DMX input and output  
 Dimensions: 275 x 310 x 110 mm  
 Net weight: 3.4 kg



**PLANO LED 6in1**  
 7x12W RGBWA + UV! LEDs

Code : B04961



**JBSYSTEMS**

7x12W six-colour RGBWA + UV LEDs  
 Beam opening: 30°  
 Infrared remote control  
 Ready for a DMX wireless connection with the WTR-DMX option  
 Digital display with drop-down menu  
 Input and output on IEC plugs  
 Modes of operation:  
 Standalone, Master/slave mode, DMX mode, usable with LEDCON-XL controller  
 DMX input and output  
 Power consumption: 50 W  
 Power supply: AC 100/240V - 50/60Hz  
 Dimensions: 210 x 130 x 230 mm  
 Net weight: 2.83 kg

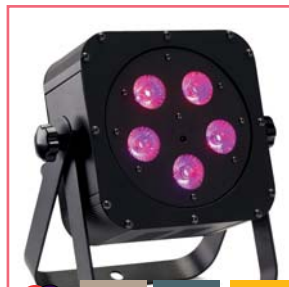

7x12W six-colour RGBWA + UV LEDs  
 Beam opening: 30°  
 Infrared remote control  
 Ready for a DMX wireless connection with the WTR-DMX option  
 Digital display with drop-down menu  
 Input and output on IEC plugs  
 Modes of operation:  
 Standalone, Master/slave mode, DMX mode, usable with LEDCON-XL controller  
 DMX input and output  
 Power consumption: 50 W  
 Power supply: AC 100/240V - 50/60Hz  
 Dimensions: 210 x 130 x 230 mm  
 Net weight: 2.83 kg





**irLEDFLAT-5x12SIXb**  
 Compact projector with six-colour LEDs, 5x12W LEDs

Code : H10142

**Contest** 

5x12W six-colour RGBWA + UV LEDs  
 Beam opening: 40°  
 Light intensity: 580 Lux at 3 m  
 Infrared remote control  
 Digital display with drop-down menu  
 Input and output on IEC plugs  
 Modes of operation:  
 2-9 channel DMX, fixed colours, Step or Fade programs, Auto mode with sound sensitivity, Slave Mode, Editing and playback of a 20-step program  
 Power consumption: 80 W  
 Power supply: AC 100/240V - 50/60Hz  
 DMX input and output  
 Dimensions: 240 x 265 x 110 mm  
 Net weight: 2.8 kg









**irLDFLAT**  
**5x12IfXb-Air**  
 5 DMX six-colour wireless LEDs

Code : H10525

**Contest** 

5x12W six-colour RGBWA + UV LEDs  
 Beam opening: 40°  
 Light intensity: 580 Lux at 3 m  
 Wireless airDMX embedded transmitter and receiver. 2.4-GHz frequency band  
 Compatible with AirBox-ER1 housing  
 Infrared remote control  
 Digital display with drop-down menu  
 Input and output on IEC plugs  
 Modes of operation:  
 2-9 channel DMX, fixed colours, Step or Fade programs, Auto mode with sound sensitivity, Slave Mode, Editing and playback of a 20-step program  
 Power consumption: 80 W  
 Power supply: AC 100/240V - 50/60Hz  
 DMX input and output  
 Dimensions: 240 x 265 x 110 mm  
 Net weight: 2.8 kg



**irLEDFLAT-3x12SIXb**  
 Six-colour LEDs, 3x12W LEDs

Code : H10141

**Contest** 

3x12W six-colour RGBWA + UV LEDs  
 Beam opening: 40°  
 Light intensity: 300 Lux at 3 m  
 Infrared remote control  
 Digital display with drop-down menu  
 Input and output on IEC plugs  
 Modes of operation:  
 2-9 channel DMX, fixed colours, Step or Fade programs, Auto mode with sound sensitivity, Slave Mode, Editing and playback of a 20-step program  
 Power consumption: 45 W  
 Power supply: AC 100/240V - 50/60Hz  
 DMX input and output  
 Dimensions: 212 x 218 x 110 mm  
 Net weight: 2.1 kg



3x12W six-colour RGBWA + UV LEDs  
 Beam opening: 40°  
 Light intensity: 300 Lux at 3 m  
 Infrared remote control  
 Digital display with drop-down menu  
 Input and output on IEC plugs  
 Modes of operation:  
 2-9 channel DMX, fixed colours, Step or Fade programs, Auto mode with sound sensitivity, Slave Mode, Editing and playback of a 20-step program  
 Power consumption: 45 W  
 Power supply: AC 100/240V - 50/60Hz  
 DMX input and output  
 Dimensions: 212 x 218 x 110 mm  
 Net weight: 2.1 kg





IP20 7x8W RGBW 30°

### LED PLANO 7FC-BLACK

7x8W RGBW LEDs

Code : B04958

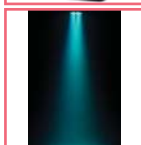

IP20 7x8W RGBW 30°

### LED PLANO 7FC-WHITE

7x8W RGBW LEDs

Code : B04959



IP20 5x5W RGBW 10°

### irLEDFLAT 5x5QCb10°-Air

5 10° 4-colour LEDs with wireless DMX

Code : H10527



7x8W RGBW LEDs  
Beam opening: 30°  
Infrared remote control  
Ready for a DMX wireless connection with the WTR-DMX option  
Digital display with drop-down menu  
Input and output on IEC plugs  
Modes of operation:  
Standalone, Master/slave mode, DMX mode, usable with LEDCON-02 or LEDCON-XL controllers  
DMX input and output  
Finish: black  
Power consumption: 38 W  
Power supply: AC 100/240V - 50/60Hz  
Dimensions: 210 x 120 x 220 mm  
Net weight: 2.35 kg

7x8W RGBW LEDs  
Beam opening: 30°  
Infrared remote control  
Ready for a DMX wireless connection with the WTR-DMX option  
Digital display with drop-down menu  
Input and output on IEC plugs  
Modes of operation:  
Standalone, Master/slave mode, DMX mode, usable with LEDCON-02 or LEDCON-XL controllers  
DMX input and output  
Finish: white  
Power consumption: 38 W  
Power supply: AC 100/240V - 50/60Hz  
Dimensions: 210 x 120 x 220 mm  
Net weight: 2.35 kg

5x5W RGBW LEDs  
Beam opening: 10°  
Light intensity: 640 Lux at 3 m  
Wireless airDMX embedded transmitter and receiver. 2.4-GHz frequency band  
Compatible with AirBox-ER1  
Infrared remote control  
Digital display with drop-down menu  
Input and output on IEC plugs  
Modes of operation:  
2-7 channel DMX, Fixed colours, Step or Fade programs, Auto mode with sound sensitivity, Slave Mode, Editing and playback of a 20-step program  
Power consumption: 30 W  
Power supply: AC 100/240V - 50/60Hz  
DMX input and output  
Dimensions: 240 x 265 x 110 mm  
Net weight: 2.8 kg



IP20 5x5W RGBW 40°

### irLEDFLAT-5x5QCb

5x5W RGBW LEDs - Black finish - Infrared remote control

Code : H9917



IP20 5x5W RGBW 40°

### irLEDFLAT-5x5QCb-Air

5x5W RGBW wireless DMX LEDs

Code : H10524



IP20 5x5W RGBW 25°

### irLEDFLAT-5x5QCb25°

Compact projector with 5W RGBW LEDs Black finish - infrared remote control - 25°

Code : H9973



5x5W RGBW LEDs  
Beam opening: 40°  
Light intensity: 640 Lux at 3 m  
Infrared remote control  
Digital display with drop-down menu  
Input and output on IEC plugs  
Modes of operation:  
2-7 channel DMX, Fixed colours, Step or Fade programs, Auto mode with sound sensitivity, Slave mode  
Power consumption: 30 W  
Power supply: AC 100/240V - 50/60Hz  
DMX input and output  
Dimensions: 240 x 265 x 110 mm  
Net weight: 2.8 kg



5x5W RGBW LEDs  
Beam opening: 40°  
Light intensity: 640 Lux at 3 m  
Wireless airDMX embedded transmitter and receiver. 2.4-GHz frequency band  
Compatible with AirBox-ER1 housing  
Infrared remote control  
Digital display with drop-down menu  
Input and output on IEC plugs  
Modes of operation:  
2-7 channel DMX, Fixed colours, Step or Fade programs, Auto mode with sound sensitivity, Slave Mode, Editing and playback of a 20-step program  
Power consumption: 30 W  
Power supply: AC 100/240V - 50/60Hz  
DMX input and output  
Dimensions: 240 x 265 x 110 mm  
Net weight: 2.8 kg

5x5W RGBW LEDs  
Beam opening: 25°  
Light intensity: 640 Lux at 3 m  
Infrared remote control  
Digital display with drop-down menu  
Input and output on IEC plugs  
Modes of operation:  
2-7 channel DMX, Fixed colours, Step or Fade programs, Auto mode with sound sensitivity, Slave mode  
Power consumption: 30 W  
Power supply: AC 100/240V - 50/60Hz  
DMX input and output  
Dimensions: 240 x 265 x 110 mm  
Net weight: 2.8 kg



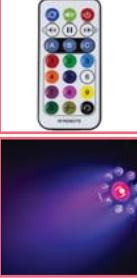

# FLAT PROJECTORS

**30W**  
COB

**9x4W**  
RGB UV



**10W**  
STROBE

**RAVE SPOT**  
3 effects in a single device. Wireless DMX

Code : B06201



3 effects in a single device!  
9 x4W RGB UV LEDs  
1 central 30W RGB COB LED.  
Strobe LED: 21x0,5 W white LEDs.  
Infrared remote control  
Ready for a DMX wireless connection with the WTR-DMX option  
Digital display with drop-down menu  
Input and output on IEC plugs  
Modes of operation: Standalone, Master/slave mode, 1-22 channel DMX mode  
DMX input and output  
Power consumption: 78 W  
Power supply: AC 100/240V - 50/60Hz  
Dimensions: 280 x 275 x 76 mm  
Net weight: 1.81 kg





**7x8W**  
RGBW

**IP20**

**PARTY SPOT**  
7x8W RGBW compact LEDs

Code : B04189



7x8W RGBW LEDs  
Digital display with drop-down menu  
Input and output on IEC plugs  
Modes of operation:  
Standalone, Master/slave mode, DMX mode, usable with LEDCON-02 or LED-CON-XL controllers  
DMX input and output  
Power consumption: 38 W  
Power supply: AC 100/240V - 50/60Hz  
Dimensions: 190 x 190 x 140 mm  
Net weight: 1.48 kg





**100W**  
COB

**70°**  
**15°**

**COB SLIM100-RGB**  
Energy efficient compact COB LED projector!

Code : B04415



1x100W RGB COB LED  
Beam opening: 15° or 70°  
Light intensity: 1165 Lux at 3 m at 15°  
Ready for a DMX wireless connection with the WTR-DMX option  
Infrared remote control  
Digital display with drop-down menu  
Mains input/output on Powercon plugs  
Modes of operation:  
Standalone, Master/slave, DMX mode, usable with LEDCON-02 MK2 controllers  
Power consumption: 120 W  
Power supply: AC 100/240V - 50/60Hz  
DMX input and output  
Dimensions: 245 x 280 x 140 mm  
Net weight: 3.46 kg





**36W**  
COB



**100°**  
**15°**

**COB-PLANO**  
36W RGB COB, 100°+15°

Code : B04951



1x36W RGB COB LED  
Beam opening: 15° or 100°  
Infrared remote control  
Digital display with drop-down menu  
Input and output on IEC plugs  
Modes of operation:  
Standalone, Master/slave, DMX mode, usable with LEDCON-02 MK2 controllers  
Power consumption: 40 W  
Power supply: AC 100/240V - 50/60Hz  
DMX input and output  
Dimensions: 202 x 120 x 224 mm  
Net weight: 2.14 kg





**30W**  
COB

**25°**  
**80°**

**irLEDFLAT-1x30TCb**  
30W compact COB LED projector with FROST diffuser filter

Code : H10130



1x30W RGB COB LED  
Beam opening: 25° or 80°  
Light intensity: 410 Lux at 3 m at 25°  
Digital display with drop-down menu  
Input and output on IEC plugs  
Modes of operation:  
2-6 channel DMX, Fixed colours, Step or Fade programs, Auto mode with sound sensitivity, Slave mode, Editing and playback of a 20-step program  
Power consumption: 45 W  
Power supply: AC 100/240V - 50/60Hz  
DMX input and output  
Dimensions: 208 x 221 x 120 mm  
Net weight: 2.1 kg





**4x36W**  
COB RGB

**15°**  
**100°**

**COB-4BAR**  
4xCOB RGB 36W + IR + Flight case

Code : B04952



4x1 36W RGB COB LED  
Beam opening: 15° or 100°  
Infrared remote control  
Ready for a DMX wireless connection with the WTR-DMX option  
Digital display with drop-down menu  
Input and output on IEC plugs  
Modes of operation:  
Standalone, Master/slave, DMX mode, usable with LEDCON-02 MK2 or COB-4BAR FOOTCONTROL controllers  
Power consumption: 120 W  
Power supply: AC 100/240V - 50/60Hz  
DMX input and output  
Dimensions: 1000 x 82 x 320mm  
Net weight: 11 kg



### COB-4BAR FOOT-CONTROL

Pedal assembly for COB-4BAR

Code : B04953



### LIVESET

Bar with 4 projectors with 3x9W RGB LEDs and 4x1W white flash LEDs

Code : H10482



### MINISET

Animation light bar with 4 projectors

Code : H10201



12x9W tricolour LEDs  
4x1W white LEDs (strobe)  
Beam opening: 15°  
WIFI pedal assembly  
Modes of operation: DMX, Standalone, Musical, Master/slave  
1.5m-2m adjustable tripod  
Transport bag for light bar+pedal assembly  
Carrying case for the tripod supplied  
Power supply: 100-240V 50/60Hz  
Power consumption: 108W  
Dimensions: 1032 x 70 x 235 mm  
Net weight: 10.2 kg

12x9W tricolour LEDs  
Beam opening: 15°  
Pedal assembly for Blackout and programs  
Modes of operation: DMX, Standalone, Musical, Master/slave  
1.5m-2m adjustable tripod  
Transport bag for light bar+pedal assembly  
Carrying case for the tripod supplied  
Power supply: 100-240V 50/60Hz  
Power consumption: 55W  
Dimensions: 910 x 242 x 50 mm  
Net weight: 10 kg



### CASE for 4x COB-PLANO

4x COB-PLANO + 1x LEDCON-02 Mk2

Code : B03252



### LIGHT EFFECT CASE 1

Solid flight case for the transport of light effects.

Code : B03216



### CASE for COB-4BAR

Lightweight and compact case, specially designed to carry a COB-4BAR

Code : B03249



### FLY8-irLEDFLAT

Flight case for 8x FLAT12SIX

Code : H10739





Lightweight and compact case designed for 4x COB-PLANO + LEDCON-02 Mk2  
External dimensions: 550 x 315 x 250 mm

Solid flight case for transport  
Divided into 5 compartments:  
2x compartments (465x285x260mm)  
1x compartment (190x69x260mm)  
1x compartment (150x69x260mm)  
1x compartment (95x69x260mm)

Lightweight and compact case, specially designed to carry a COB-4BAR  
External dimensions: 105 x 34 x 16 cm

# PAR PROJECTORS



**irLED64-18x12fXsb-Air**  
PAR64 with 18 RGBWAUV LEDs - Wireless DMX

Code : H10532



18x12W six-colour RGBWA + UV LEDs  
Beam opening: 40°  
Light intensity: 3350 Lux at 3 m  
Wireless airDMX embedded transmitter and receiver: 2.4-GHz frequency band  
Compatible with AirBox-ER1  
Infrared remote control  
Digital display with drop-down menu  
Input and output on IEC plugs  
Modes of operation:  
2-9 channel DMX, fixed colours, Step or Fade programs, Auto mode with sound sensitivity, Slave Mode, Editing and playback of a 20-step program  
Power consumption: 240 W  
Power supply: AC 100/240V - 50/60Hz  
DMX input and output  
Black aluminium housing  
Dimensions: 340 x 270 x 220 mm  
Net weight: 5.4 kg





**irLED64-18x12SIXsb**  
PAR64 with RGBWAUV LEDs - With infrared remote control

Code : H10138



18x12W six-colour RGBWA + UV LEDs  
Beam opening: 40°  
Light intensity: 3350 Lux at 3 m  
Infrared remote control  
Digital display with drop-down menu  
Input and output on IEC plugs  
Modes of operation:  
2-9 channel DMX, Fixed colours, Step or Fade programs, Auto mode with sound sensitivity, Slave Mode, Editing and playback of a 20-step program  
Power consumption: 240 W  
Power supply: AC 100/240V - 50/60Hz  
DMX input and output  
Black aluminium housing  
Dimensions: 340 x 270 x 220 mm  
Net weight: 5.4 kg









**irLED64-18x12SIXss**  
PAR64 with RGBWAUV LEDs - With infrared remote control - Aluminium

Code : H10137

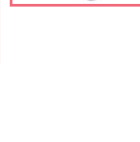

18x12W six-colour RGBWA + UV LEDs  
Beam opening: 40°  
Light intensity: 3350 Lux at 3 m  
Infrared remote control  
Digital display with drop-down menu  
Input and output on IEC plugs  
Modes of operation:  
2-9 channel DMX, Fixed colours, Step or Fade programs, Auto mode with sound sensitivity, Slave Mode, Editing and playback of a 20-step program  
Power consumption: 240 W  
Power supply: AC 100/240V - 50/60Hz  
DMX input and output  
Silver aluminium housing  
Dimensions: 340 x 270 x 220 mm  
Net weight: 5.4 kg







**irLED64-18x10FIVEsb**  
PAR64 with 18x10W 5-colour LEDs  
Black finish

Code : H10072



18x10W RGB White + Amber LEDs  
Beam opening: 40°  
Light intensity: 2150 Lux at 3 m  
Infrared remote control  
Digital display with drop-down menu  
Input and output on IEC plugs  
Modes of operation:  
2-8 channel DMX, Fixed colours, Step or Fade programs, Auto mode with sound sensitivity, Slave mode, Editing and playback of a 20-step program  
Power consumption: 165 W  
Power supply: AC 100/240V - 50/60Hz  
DMX input and output  
Black aluminium housing  
Dimensions: 340 x 270 x 220 mm  
Net weight: 4.6 kg

**irLED64-18x10FIVEss**  
PAR64 with 18x10W 5-colour LEDs - Aluminium finish

Code : H10073



18x10W RGB White + Amber LEDs  
Beam opening: 40°  
Light intensity: 2150 Lux at 3 m  
Infrared remote control  
Digital display with drop-down menu  
Input and output on IEC plugs  
Modes of operation:  
2-8 channel DMX, Fixed colours, Step or Fade programs, Auto mode with sound sensitivity, Slave mode, Editing and playback of a 20-step program  
Power consumption: 165 W  
Power supply: AC 100/240V - 50/60Hz  
DMX input and output  
Silver aluminium housing  
Dimensions: 340 x 270 x 220 mm  
Net weight: 4.6 kg





18x3W  
RGB 40°

**irLED64-18x3TCsb**  
PAR64 with 18x3W TRI LEDs Black finish

Code : H9876

**Contest**

18x3W RGB LEDs  
Beam opening: 40°  
Light intensity: 1150 Lux at 3 m  
Infrared remote control  
Digital display with drop-down menu  
Input and output on IEC plugs  
Modes of operation:  
2-6 channel DMX, Fixed colours, Step or Fade programs, Auto mode with sound sensitivity, Slave mode,  
Power consumption: 60 W  
Power supply: AC 100/240V - 50/60Hz  
DMX input and output  
Black aluminium housing  
Dimensions: 340 x 270 x 220 mm  
Net weight: 4.3 kg



18x3W  
RGB 40°

**irLED64-18x3TCss**  
PAR64 with 18x3W TRI LEDs Aluminium finish

Code : H9875

**Contest**

18x3W RGB LEDs  
Beam opening: 40°  
Light intensity: 1150 Lux at 3 m  
Infrared remote control  
Digital display with drop-down menu  
Input and output on IEC plugs  
Modes of operation:  
2-6 channel DMX, Fixed colours, Step or Fade programs, Auto mode with sound sensitivity, Slave mode,  
Power consumption: 60 W  
Power supply: AC 100/240V - 50/60Hz  
DMX input and output  
Silver aluminium housing  
Dimensions: 340 x 270 x 220 mm  
Net weight: 4.3 kg



**FLY-irLED64x6**  
Flight case for 6 PAR64

Code : H10338

**Contest**

External dimensions - L x W x H:  
850 x 580 x 585 mm  
Compartment dimensions:  
260 x 260 mm Depth: 440 mm  
Hood thickness: 65 mm



12x3W  
RGB 40°

**irLED56-12x3TCsb**  
PAR56 with 12x3W TRI LEDs - Black finish

Code : H9872

**Contest**

12x3W RGB LEDs  
Beam opening: 40°  
Light intensity: 1030 Lux at 3 m  
Infrared remote control  
Digital display with drop-down menu  
Input and output on IEC plugs  
Modes of operation:  
2-6 channel DMX, Fixed colours, Step or Fade programs, Auto mode with sound sensitivity, Slave mode,  
Power consumption: 40 W  
Power supply: AC 100/240V - 50/60Hz  
DMX input and output  
Black aluminium housing  
Dimensions: 360 x 270 x 170 mm  
Net weight: 2.8 kg



12x3W  
RGB 40°

**irLED56-12x3TCss**  
PAR56 projector with 12 3W TRI LEDs Aluminium finish - Infrared remote control

Code : H9871

**Contest**

12x3W RGB LEDs  
Beam opening: 40°  
Light intensity: 1030 Lux at 3 m  
Infrared remote control  
Digital display with drop-down menu  
Input and output on IEC plugs  
Modes of operation:  
2-6 channel DMX, Fixed colours, Step or Fade programs, Auto mode with sound sensitivity, Slave mode,  
Power consumption: 40 W  
Power supply: AC 100/240V - 50/60Hz  
DMX input and output  
Silver aluminium housing  
Dimensions: 360 x 270 x 170 mm  
Net weight: 2.8 kg



12x12W  
RGBWAUV 15°

**BT-STAGEPAR 6in1**  
12x12W RGBWA projector + UV - 15°

Code : B04377

**BriteQ**  
LIGHT RESEARCH

12x12W six-colour RGBWA + UV LEDs  
Beam opening: 25°  
Digital display with drop-down menu  
Mains output on IEC plugs  
Modes of operation:  
1-9 channel DMX, Fixed colours, Step or Fade programs, Auto mode with sound sensitivity, Slave mode,  
Mode: Halogen lamp or Diode  
White balance  
Remote setup: RDM  
Power supply: AC 100/240V - 50/60Hz  
DMX input and output  
finish: black  
Dimensions: 300 x 275 x 300 mm  
Net weight: 3.5 kg



# PAR PROJECTORS



CW 100W 5600k 60°

**COB PAR56-100CW BLACK**  
LED projector with parabolic reflector

Code : B04409



Optics: 1x100W 5600K COB LED  
Opening angle: 60°  
Digital display with drop-down menu  
Mains output on IEC plugs  
Modes of operation:  
1-2 channel DMX, Fixed colours, Step or Fade programs, Auto mode with sound sensitivity, Slave mode,  
Mode: Halogen lamp or Diode  
Power supply: 100-240V/50-60Hz  
DMX input and output  
Finish: black  
Dimensions: 417 x 286 x 260 mm  
Weight: 2.8 kg



CW 100W 5600K 60°

**SILVER COB PAR56-100CW**  
LED projector with parabolic reflector

Code : B04408



Optics: 1x100W 5600K COB LED  
Opening angle: 60°  
Digital display with drop-down menu  
Mains output on IEC plugs  
Modes of operation:  
1-2 channel DMX, Fixed colours, Step or Fade programs, Auto mode with sound sensitivity, Slave mode,  
Mode: Halogen lamp or Diode  
Power supply: 100-240V/50-60Hz  
DMX input and output  
Finish: silver  
Delivered with 25° lens, filter door  
Dimensions: 417 x 286 x 260 mm  
Weight: 2.8 kg



WW 100W 3200K 60°

**BLACK COB PAR56-100WW**  
LED projector with parabolic reflector

Code : B04411



Optics: 1x100W 3200K COB LED  
Opening angle: 60°  
Digital display with drop-down menu  
Mains output on IEC plugs  
Modes of operation:  
1-2 channel DMX, Fixed colours, Step or Fade programs, Auto mode with sound sensitivity, Slave mode,  
Mode: Halogen lamp or Diode  
Power supply: 100-240V/50-60Hz  
DMX input and output  
Finish: black  
Delivered with 25° lens, filter door  
Dimensions: 417 x 286 x 260 mm  
Weight: 2.8 kg



WW 100W 3200K 60°

**SILVER COB PAR56-100WW**  
LED projector with parabolic reflector

Code : B04410



Optics: 1x100W 3200K COB LED  
Opening angle: 60°  
Digital display with drop-down menu  
Mains output on IEC plugs  
Modes of operation:  
1-2 channel DMX, Fixed colours, Step or Fade programs, Auto mode with sound sensitivity, Slave mode,  
Mode: Halogen lamp or Diode  
Power supply: 100-240V/50-60Hz  
DMX input and output  
Finish: silver  
Delivered with 25° lens, filter door  
Dimensions: 417 x 286 x 260 mm  
Weight: 2.8 kg



100W COB RGB 50°

**PAR56-RGB COB**  
100xW RGB COB LED

Code : B04403



Optics: 1x100W RGB COB LED  
Opening angle: 50°  
Digital display with drop-down menu  
Mains output on IEC plugs  
Modes of operation:  
3-, 4- and 5-channel DMX, Fixed colours, Step or Fade programs, Auto mode with sound sensitivity, Slave mode,  
Power supply: 100-240V/50-60Hz  
DMX input and output  
Finish: black  
Delivered with 25° lens, filter door  
Dimensions: 417 x 286 x 260 mm  
Weight: 2.8 kg



**COB BARNDOOR/Black**  
Barndoor for COB PAR56

Code : B04413





**COB BARNDOOR/Silver**  
Barndoor for COB PAR56

Code : B04414



**PROJECTOR CASE**  
Flight case for carrying 4 projectors

Code : B03253



For:  
BRITEQ COB-PAR  
BRITEQ BT-Stagepar 6in1  
BRITEQ BT-Theatre 1EZ  
BRITEQ BT-Theatre 100EC



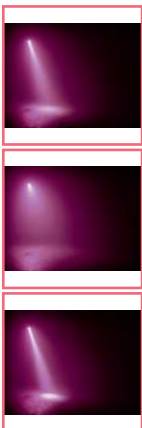

**RETRO-PAR20 RGBW**  
15W RGBW RETRO-PAR20 LED IR Remote Control

Code : B05129



**PIN15QC**  
4° beam projector with 15W 4-colour LEDs

Code : H10595



**PIN15W**  
4° beam projector with 15W warm white LED

Code : H10709



RETRO-PAR20 LED projector  
1x15W RVBW LED.  
Opening: 10°  
Infrared remote control IR-3  
16 fixed colours (with dimming).  
"Fade", "soft transition" and "flash"  
colour interlacing (with speed control).  
Strobe function (with speed control).  
Easy to use sound control mode.  
Power supply: 100-240V/50-60Hz  
finish: black  
Dimensions: 198 x 112 x 100 mm  
Weight: 0.65 kg

1x15W RGBW LED  
Openings: 4° | 10° | 45°  
Power consumption: 17 W  
Power supply: AC100V-240V. 60Hz-50Hz  
IEC IN/OUT  
DMX 3-pin IN/OUT  
Automatic or music programs DMX  
Control: 1,4,7,12 channels  
Infrared remote control  
Dimensions: 135 x 203 x 172 mm  
Net weight: 1.4 kgs

1x15W warm white LED  
Openings: 4° | 10° | 45°  
Power consumption: 17 W  
Power supply: AC100V-240V. 60Hz-50Hz  
IEC IN/OUT  
DMX 3-pin IN/OUT  
Automatic or music programs DMX  
Control: 1, 2 channels  
Infrared remote control  
Dimensions: 135 x 203 x 172 mm  
Net weight: 1.4 kgs

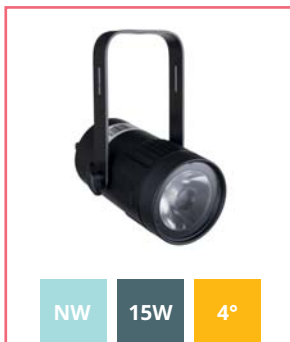
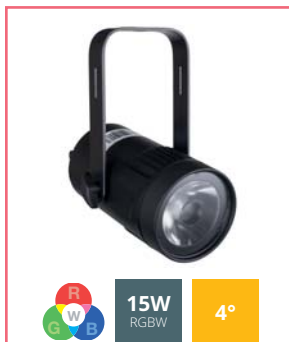

**BEAMSPOT1-DMX FC**  
15W RGBW projector, equipped with a very narrow 4° lens

Code : B04957



**BEAMSPOT1-DMX NW**  
15W WHITE projector equipped with a very narrow 4° lens.

Code : B04956



**BEAMSPOT1-DMX WW**  
15W WARM WHITE 4° lens

Code : B04960





1x15W RGBW LED  
Openings: 4° | 10° | 45°  
Power consumption: 17 W  
Power supply: AC100V-240V. 60Hz-50Hz  
Powercon IN/OUT  
DMX 3-pin IN/OUT  
DMX control: 4-7 channels  
Dimensions: 125 x 196 x 172 mm  
Net weight: 1.23 kgs

1x15W natural white 4500K LED  
Openings: 4° | 10° | 45°  
Power consumption: 17 W  
Power supply: AC100V-240V. 60Hz-50Hz  
Powercon IN/OUT  
DMX 3-pin IN/OUT  
DMX control: 1-2 channels  
Dimensions: 125 x 196 x 172 mm  
Net weight: 1.23 kgs

1x15W warm white 3200K LED  
Openings: 4° | 10° | 45°  
Power consumption: 17 W  
Power supply: AC100V-240V. 60Hz-50Hz  
Powercon IN/OUT  
DMX 3-pin IN/OUT  
DMX control: 1-2 channels  
Dimensions: 125 x 196 x 172 mm  
Net weight: 1.23 kgs

# PAR PROJECTORS

NW

15W

4°

**BEAMSPOT1-TRIAC NW**  
15W WHITE projector



---

Code : B04955

---



1x15W natural white 4500K LED  
 Openings: 4° | 10° | 45°  
 NO DMX: can be controlled using a traditional triac dimmer / triac light modulator or the dimmer located on the rear panel.  
 Power consumption: 17 W  
 Power supply: AC100V-240V. 60Hz-50Hz  
 Fixed power cord with standard power outlet  
 Dimensions: 125 x 196 x 172 mm  
 Net weight: 1.23 kgs

WW

15W

4°

**BEAMSPOT1-TRIAC WW**  
This 15W PINSPOT

---

Code : B04954

---



1x15W warm white 3200K LED  
 Openings: 4° | 10° | 45°  
 NO DMX: can be controlled using a traditional triac dimmer / triac light modulator or the dimmer located on the rear panel.  
 Power consumption: 17 W  
 Power supply: AC100V-240V. 60Hz-50Hz  
 Fixed power cord with standard power outlet  
 Dimensions: 125 x 196 x 172 mm  
 Net weight: 1.23 kgs







**LED PINSPOT**  
3W white LED projector, lenses incl. 6° + 11°

---

Code : B04918

---



1x3W LED  
 Openings: 6° | 11°  
 Power consumption: 8 W  
 Power supply: AC100V-240V. 60Hz-50Hz  
 Fixed power cord with standard power outlet  
 Dimensions: 104 x 78 x 55 mm  
 Net weight: 0.44 kgs



**PAR46/black**  
PAR 46 with black E27 socket.

---

Code : B02066

---



Ideal for stores and showrooms!  
 Power cord included  
 E27 socket for PAR 38 lamp (lamp not included)  
 Filter holder included  
 Finish: black  
 Total length without holder: 31cm barn-door option available



**PAR46/silver**  
PAR 46 with chrome-coloured E27 socket.

---

Code : B02053

---



Ideal for stores and showrooms!  
 Power cord included  
 E27 socket for PAR 38 lamp (lamp not included)  
 Filter holder included  
 Finish: silver  
 Total length without holder: 31cm barn-door option available



**PAR46-BARN/black**  
Barndoor for PAR46

Code : B02079



**PAR46-BARN/silver**  
Barndoor for PAR46

Code : B02080



**PINSPOT/Black**  
Projector for PAR36 lamp

Code : B02034



Projector for 30W/6V PAR 36 lamp  
Equipped with a transformer, fuse holder and clips to fix the lamp  
Finish: black  
Without lamp



**PAR30/black**  
Projector for PAR30 or PAR20 lamp

Code : B02088



**PAR30/silver**  
Projector for PAR30 or PAR20 lamp

Code : B02087



**PAR30-BARN/black**  
Barndoor for PAR30

Code : B02077



**PAR30-BARN/silver**  
Barndoor for PAR30

Code : B02078



Projector for Par 30 or Par 20 lamp  
Compatible with halogen lamps and E27 socket LED lamps  
Power supply 230V AC  
Finish: black  
Total length without holder: 22 cm  
Without lamp

Projector for Par 30 or Par 20 lamp  
Compatible with halogen lamps and E27 socket LED lamps  
Power supply 230V AC  
Finish: silver  
Total length without holder: 22 cm  
Without lamp



# PAR PROJECTORS



**PAR20/black**  
Projector for PAR20 lamp

Code : B02086



Projector for PAR20 lamp  
Finish: black  
Total length without holder: 17cm  
Without lamp



**PAR20/silver**  
Projector for PAR20 lamp

Code : B02085



Projector for PAR20 lamp  
Finish: silver  
Total length without holder: 17cm  
Without lamp



**PAR20-BARN/black**  
Barndoor for PAR20

Code : B02075



**PAR20-BARN/silver**  
Barndoor for PAR20

Code : B02076



**PAR16/black GU10 socket**  
Projector for PAR16 lamp

Code : B02061



GU10 socket for the use of: LED lamps (GU10) Halogen lamp (35W or 50W/230V)  
Finish: black  
No transformer necessary  
Total length without holder: 14.5cm  
Without lamp



**PAR16/Silver GU10 socket**  
Projector for PAR16 lamp

Code : B02055



GU10 socket for the use of: LED lamps (GU10) Halogen lamp (35W or 50W/230V)  
Finish: silver  
No transformer necessary  
Total length without holder: 14.5cm  
Without lamp



**PAR16-BARN/black**  
Barndoor for PAR16

Code : B02073



**PAR16-BARN/silver**  
Barndoor for PAR16

Code : B02074



**TF36**  
Transformer for PAR36 lamp (30W/6V)

Code : B02045





# Artist10W

La projection gobo sur-mesure\*

\*Tailor-made gobo projection



I love you  
Mary



by **Contest**





# PANELS, BLINDERS AND FLOOD

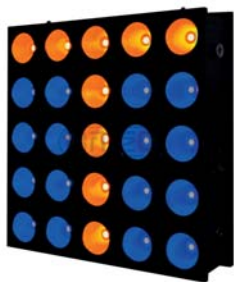

**POWERMATRIX5x5-RGB Mk2**  
25 30W RGB COB LED Flood Projector

Code : B04412



25 COB LEDs  
30W tri-colour LEDs  
Beam opening: 60°  
Neutrik® PowerCon inputs/outputs  
DMX 3 and 5-pin inputs/outputs. Consumption: 750W  
Power supply: AC 100/240V - 50/60Hz  
Cooling by temperature regulated ventilation  
Dimensions: 55 x 55 x 12 cm  
Net weight: 14.5 kg



**POWERMATRIX5x5-BRACKET**  
Suspensions for POWERMATRIX5x5 RGB, POWERMATRIX5x5 RGB Mk2, ...

Code : B04407



Specially designed for suspension of POWERMATRIX5x5 RGB projectors  
Perfect for mounting several POWERMATRIX5x5 RGB in structures in matrix form  
Robust metal design with additional reinforcements Equipped with a special "coffin lock" mechanism for quick and easy installation.



**POWERMATRIX5x5-CASE**  
Flight case for 6x PowerMatrix5x5

Code : B04406



**PIX44**  
16 30W TRI COB LED Flood Projector With LCD display

Code : H10016



16 COB LEDs  
30W tri-colour LEDs  
Beam opening: 60°  
DMX 3- and 5-pin XLR input and output  
Power input and output on PowerCON (maximum 5 projectors connected to each other)  
Power consumption: 500W  
Power supply: AC 100/240V - 50/60Hz  
Cooling by temperature regulated ventilation  
Dimensions: 345 x 345 (365 with the moving head) x 180 mm  
Net weight: 8.25 Kg



**PIX18**  
Bar with 8 30W TRI COB LEDs  
With LCD display

Code : H10018



8 COB LEDs  
30W tri-colour LEDs  
Beam opening: 60°  
DMX 3- and 5-pin XLR input and output  
Power input and output on PowerCON® (maximum 10 projectors connected to each other)  
Power consumption: 240 W  
Power supply: AC 100/240V - 50/60Hz  
Cooling by temperature regulated ventilation  
Dimensions: 880 x 60 x 170 mm  
Net weight: 8 Kg



**Powerpixel8-RGB**  
Bar with 8 30W TRI COB LEDs  
With LCD display

Code : B04401



8 COB LEDs  
30W tri-colour LEDs  
Beam opening: 60°  
DMX 3- and 5-pin XLR input and output  
Power input and output on PowerCON® (maximum 10 projectors connected to each other)  
Power consumption: 240 W  
Power supply: AC 100/240V - 50/60Hz  
Cooling by temperature regulated ventilation  
Dimensions: 880 x 60 x 170 mm  
Net weight: 8 Kg



**PIX14**  
Bar with 4 30W TRI COB LEDs  
With LCD display

Code : H10017



4 COB LEDs  
30W tri-colour LEDs  
Beam opening: 60°  
DMX 3- and 5-pin XLR input and output  
Power input and output on PowerCON® (maximum 20 projectors connected to each other)  
Power consumption: 120 W  
Power supply: AC 100/240V - 50/60Hz  
Cooling by temperature regulated ventilation  
Dimensions: 440 x 150 x 180 mm  
Net weight: 5 Kg



**Powerpixel4-RGB**  
Bar with 4 30W TRI COB LEDs  
With LCD display

Code : B04400



4 COB LEDs  
30W tri-colour LEDs  
Beam opening: 60°  
DMX 3- and 5-pin XLR input and output  
Power input and output on PowerCON® (maximum 20 projectors connected to each other)  
Power consumption: 120 W  
Power supply: AC 100/240V - 50/60Hz  
Cooling by temperature regulated ventilation  
Dimensions: 440 x 150 x 180 mm  
Net weight: 5 Kg



### PROJECTOR CASE 2

Flight case for POWERPIXEL8-RGB, POWERPIXEL4-RGB, BEAMBAR10-RGBW, BEAMBAR5-RGBW

Code : B03257



### COB Blinder 2x100W

LED BLINDER equipped with two white 100Watt LED projectors

Code : B04402



LED BLINDER equipped with two white 100Watt 3200k LED projectors  
 Opening angle: 60°  
 The two projectors can be controlled independently  
 DMX mode: 1, 2 or 4 channels  
 Static mode: Stroboscopic effect dimmer Master/Slave Mode, Variable stroboscopic effect  
 Halogen (slow) or LED (fast) mode  
 Dimming 16 bit from 0% to 100%  
 DMX IN/OUT on XLR 3/5-pin plug  
 POWER IN/OUT with Powercon  
 Power: AC 100 - 240V, 50/60Hz  
 Power consumption: 235W  
 Dimensions: 440 x 144 x 355 mm  
 Weight: 4.46 kg



### BEAM MATRIX5x5-RGBW

5x5 MATRIX effect, 25x 15W RGBW 4.5°beams + Artnet

Code : B04416



25 15W RGBW LEDs 5x5 Matrix  
 Lens opening: 4.5°  
 DMX mode: 4-150 channels  
 Ethernet input/output: Art-Net support  
 Internal programs in standalone mode or via DMX, Master/slave mode, static or fade colours, static or sound-triggered chasers.  
 Halogen (slow) or LED (fast) mode  
 Balancing of individual whites by Pixel  
 Four intensity variation curves  
 DMX IN/OUT on XLR 3/5-pin plug  
 POWER IN/OUT with Powercon  
 Power: AC 100 - 240V, 50/60Hz  
 Power consumption: 415W  
 Dimensions: 550 x 550 x 120 mm  
 Weight: 18 kg



### MATRIX5x5-CASE

Flight case for 6x MATRIX5x5

Code : B04422



# PANELS, BLINDERS AND FLOOD



**BEAMBAR10-RGBW**  
LED Narrow Beam Bar, 10x 15W RGBW  
Osram + Artnet

Code : B04418

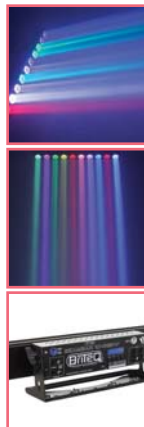

**BEAMBAR5-RGBW**  
LED Narrow Beam Bar, 5x 15W RGBW  
Osram + Artnet

Code : B04419



**PIX9W44**  
16 9W TRI LED Flood Projector

Code : H10135



10 15W RGBW Osram LEDs  
Lens opening: 4.5°  
Frost filter: included  
DMX mode: 3-60 channels  
Ethernet input/output: Art-Net support  
Internal programs in standalone mode or via DMX, Master/slave mode, static or fade colours, static or sound-triggered chasers.  
Halogen (slow) or LED (fast) mode  
Balancing of individual whites by Pixel  
Four intensity variation curves  
DMX IN/OUT on XLR 3/5-pin plug  
POWER IN/OUT with Powercon  
Power: AC 100 - 240V, 50/60Hz  
Power consumption: 180W  
Dimensions: 880 x 182 x 160 mm  
Weight: 9.33 kg

5 15W RGBW Osram LEDs  
Lens opening: 4.5°  
Frost filter: included  
DMX mode: 3-30 channels  
Ethernet input/output: Art-Net support  
Internal programs in standalone mode or via DMX, Master/slave mode, static or fade colours, static or sound-triggered chasers.  
Halogen (slow) or LED (fast) mode  
Balancing of individual whites by Pixel  
Four intensity variation curves  
DMX IN/OUT on XLR 3/5-pin plug  
POWER IN/OUT with Powercon  
Power: AC 100 - 240V, 50/60Hz  
Power consumption: 100W  
Dimensions: 440 x 182 x 160 mm  
Weight: 6.02 kg

16 9W RGB LEDs  
Beam opening: 25°  
Digital display with drop-down menu for control  
DMX mode: 2-51 channels  
Fixed colours, Step or Fade programmes  
Auto mode, Audio mode with sound sensitivity, Slave mode  
Multi-slave mode to chain patterns across multiple devices  
DMX IN/OUT on XLR 3-pin plug  
POWER IN/OUT by IEC plug  
Power supply: AC 100/240V - 50/60Hz  
Power consumption: 200W  
temperature regulated ventilation  
Dimensions: 345 x 345 x 180 mm  
Net weight: 7.7 Kg



**PIX9W33**  
9 9W TRI LED Flood Projector

Code : H10133



**PIX9W14**  
Bar with 4 9W TRI LEDs

Code : H10134

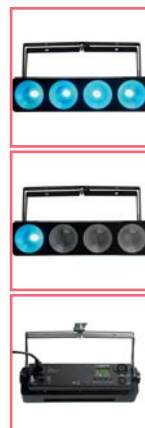

**BT-GLOWPANEL BRACKET**  
Hanger for BT-GLOWPANEL

Code : B04426



9 9W RGB LEDs  
Beam opening: 25°  
Digital display with drop-down menu for control  
DMX mode: 2-30 channels  
Fixed colours, Step or Fade programmes  
Auto mode, Audio mode with sound sensitivity, Slave mode  
Multi-slave mode to chain patterns across multiple devices  
DMX IN/OUT on XLR 3-pin plug  
POWER IN/OUT by IEC plug  
Power supply: AC 100/240V - 50/60Hz  
Power consumption: 110W temperature regulated ventilation  
Dimensions: 260 x 260 x 180 mm  
Net weight: 4.9 Kg

4 9W RGB LEDs  
Beam opening: 25°  
Digital display with drop-down menu for control  
DMX mode: 2-15 channels  
Fixed colours, Step or Fade programmes  
Auto mode, Audio mode with sound sensitivity, Slave mode  
Multi-slave mode to chain patterns across multiple devices  
DMX IN/OUT on XLR 3-pin plug  
POWER IN/OUT by IEC plug  
Power supply: AC 100/240V - 50/60Hz  
Power consumption: 48W temperature regulated ventilation  
Dimensions: 340 x 140 x 140 mm  
Net weight: 2.9 Kg

Suspension bracket for mounting BT-GLOWPANEL on a large-matrix structure.





**BT-GLOWPANEL**

Matrix with 36 - 4° lenses with RGB (glow) effects

Code : B04425



36 3W 2800K LEDs 4° lens  
144 SMD 5050 LEDs for RGB (glow) effects  
LCD display: drop-down menu for control  
5 DMX modes: 4-48 channels  
Integral DMX control with different channel modes, from simple 4-channel mode to 48-channel mode for a complete RVB+dimmer control for each pixel and panel.  
Automatic mode, Slave mode  
DMX IN/OUT on XLR 3-pin plug  
POWER IN/OUT with Powercon  
Power supply: AC 100/240V - 50/60Hz  
Power consumption: 190W  
ventilation: natural convection  
Dimensions: 500 x 500 x 84 mm  
Net weight: 8.5 Kg  
Optional suspension bracket:  
BT-GLOWPANEL BRACKET



**BT-GLOWBAR BLACK**

12 CREE 3W LEDs (2,800 K warm white), with 48 RVB 5050SMD LEDs for an RGB (glow) effect

Code : B05502



12 3W 2800K LEDs 4° lens  
48 SMD 5050 LEDs for RGB (glow) effects  
LCD display: drop-down menu for control  
6 DMX modes: 4-28 channels  
Integral DMX control with different channel modes, from simple 4-channel mode to 26/28-channel mode for a complete RVB+dimmer control for each pixel and panel.  
Automatic mode, Slave mode  
DMX IN/OUT on XLR 3/5-pin plug  
POWER IN/OUT with Powercon  
Power supply: AC 100/240V - 50/60Hz  
Power consumption: 70W  
ventilation: natural convection  
Dimensions: 100 x 83 x 109 mm  
Net weight: 5.1 Kg



**BT-GLOWBAR**

With 12 CREE 3W LEDs and 48 RVB 5050SMD LEDs

Code : B04424



12 3W 2800K LEDs 4° lens  
48 SMD 5050 LEDs for RGB (glow) effects  
LCD display: drop-down menu for control  
6 DMX modes: 4-28 channels  
Integral DMX control with different channel modes, from simple 4-channel mode to 26/28-channel mode for a complete RVB+dimmer control for each pixel and panel.  
Automatic mode, Slave mode  
DMX IN/OUT on XLR 3/5-pin plug  
POWER IN/OUT with Powercon  
Power supply: AC 100/240V - 50/60Hz  
Power consumption: 70W  
ventilation: natural convection  
Dimensions: 100 x 83 x 109 mm  
Net weight: 5.1 Kg



**BT-GLOWPANEL BLACK**

36 4° lens matrix with RGB effects

Code : B05503



36 3W 2800K LEDs 4° lens  
144 SMD 5050 LEDs for RGB (glow) effects  
LCD display: drop-down menu for control  
5 DMX modes: 4-48 channels  
Integral DMX control with different channel modes, from simple 4-channel mode to 48-channel mode for a complete RVB+dimmer control for each pixel and panel.  
Automatic mode, Slave mode  
DMX IN/OUT on XLR 3-pin plug  
POWER IN/OUT with Powercon  
Power supply: AC 100/240V - 50/60Hz  
Power consumption: 190W  
ventilation: natural convection  
Dimensions: 500 x 500 x 84 mm  
Net weight: 8.5 Kg  
Optional suspension bracket:  
BT-GLOWPANEL BRACKET



**CASE for 6x BT-GLOWPANEL**

Flight case for 6x BT-GLOWPANEL

Code : B03269



**CASE for 8x BT-GLOWBAR**

Flight case for 8x BT-GLOWBAR

Code : B03270

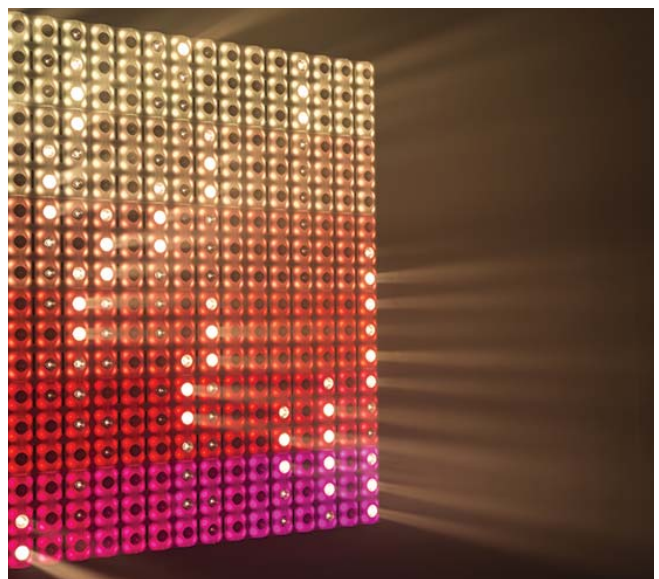

# PANELS, BLINDERS AND FLOOD

This attractive retro-style projector is perfect for many applications.

The combination of its golden reflector and an HPL-575 lamp creates a warm and pleasant light. The high-power RGB LEDs can illuminate the reflector to produce incredible additional effects.

The BT-VINTAGE has an integrated DMX control to adjust the dimmer and RGB effects. It is prepared for TV studios with a flicker-free LED refresh rate.



## BT-VINTAGE

Retro-style projector with golden reflector, HPL-575 lamp and RGB LEDs to produce incredible warm colour effects.

Code : B04547



## CASE for 2x BT-VINTAGE

Flight case for 2x BT-VINTAGE

Code : B03271



## HPL 575-X LL (code B02171)

230V halogen lamp for BT-VINTAGE. For a warm and pleasant light



RGB LEDs (156 x 1W RVB)  
Wireless DMX: USB port for WTR-DMX dongle (optional)  
PowerCON input and output  
XLR 3/5-pin input and output  
Power supply: AC 100/240V - 50/60Hz  
Power consumption: 980W  
Ventilation: natural convection  
Dimensions: 696 x 650 x 370 mm  
Net weight: 14 Kg



# MOVING HEADS

- Philips® MSD PLATINUM 15R lamp mounted
- 3-colour process with dichroic Cyan, magenta, yellow filters
- Motorised zoom x4
- Double gobo wheel
- Wheel with 6 additional colours
- 3-facet rotating prism and frost filter
- Iris

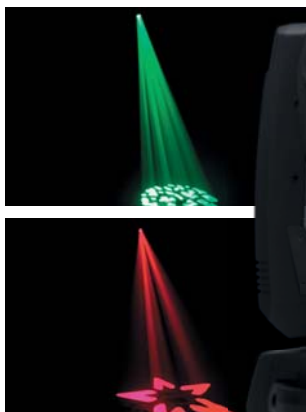

- OSRAM SIRIUS HRI 280 (7800 K°) lamp
- BEAM: from 2.6° to 11°
- SPOT: from 5.2° to 23°
- 1 wheel with 13 colours
- 14 fixed gobos + open
- 9 replaceable rotating gobos
- 8-facet prism + linear with 6 facets
- Frost | Zoom + Focus



**Evora-FLEX15R**  
Spot moving head with Philips® MSD PLATINUM 15R lamp

Code : H10295



**FLY-Flex15Rx2**  
Flight case for 2 Evora-Beam/Flex15R

Code : H10343



**BTX-TITAN**  
BEAM + SPOT + WASH effects

Code : B04378



**CASE FOR 2x BTX-TITAN**  
Flight case for 2x BTX-TITAN

Code : B03251



Philips® MSD PLATINIUM 15R source  
Opening: Variable zoom from 6 to 28°  
Light power: 38600 lux at 5m [6°]  
3-colour process with dichroic CMY filters  
Wheel with 6 dichroic colours  
Wheel with 8 rotating gobos  
Wheel with 14 fixed gobos  
3-facet rotating prism [16 Macros]  
Variable stroboscope and random strobe  
Variable iris from 5 to 100%  
Variable dimmer from 0 to 100%  
Variable frost from 0 to 100%  
Variable focus from 0 to 100%  
DMX mode: 21, 23 or 34 channels  
Drop-down menu display  
Amplitude: 540° or 630° pan - 270° tilt  
Power consumption: 400W  
Power supply: AC 100/230V - 50/60Hz  
Dimensions: 362x331x645 mm  
Net weight: 19 Kg

OSRAM SIRIUS HRI 280 source  
Beam from 2.6° to 11°: 82,650 lux at 20 m  
Spot from 5.2° to 23°: 25400 lux at 10 m  
2 combinable prisms:  
8-facet circular rotating prism  
6-facet linear rotating prism  
wheel with 9 rotating gobos + open  
wheel with 14 fixed gobos + open  
wheel with 13 dichroic colours (CTO-CTB)  
Frost effect (WASH)  
Stroboscopic effects  
Motorised Focus + Zoom  
Variable dimmer from 0 to 100%  
DMX mode: 16, 24 or 25 channels  
Drop-down menu display  
Amplitude: 540° pan - 270° tilt  
Power consumption: 400W  
Power supply: AC 100/230V - 50/60Hz  
Dimensions: 391x287x583 mm  
Net weight: 22 Kg

# MOVING HEADS



- 270W CW LED
- Linear zoom from 8 to 45°
- 3-facet prism
- Wheel with 7 rotating gobos + open
- Wheel with 9 colours including 2xCTO 1xCTB, UV + open
- Iris
- Frost
- Focus



- 3-in-1 beam, spot, wash moving head
- Powerful LED source
- 1 6-facet linear rotating prism
- 1 8-facet rotating circular prism
- Linear transition from Beam mode to Spot mode



**BTX-SATURN**  
Moving head with 270 W LED

Code : B04428



**MOVING HEAD CASE 3**  
Flight case for 4x BTX-SATURN

Code : B03273



**FUSION180**  
Beam Spot and Wash moving head with 180W LED

Code : H10661



**FLY2Fusion180**  
Flight case for 2x FUSION180

Code : H10737



270W CW LED source  
Linear zoom from 8 to 45°  
3-colour process with dichroic CMY filters  
3-facet circular rotating prism  
Wheel with 7 rotating gobos + open  
Wheel with 9 fixed gobos + 3 reducers  
Wheel with 9 colours including 2xCTO, 1xCTB, UV + open  
Variable iris  
Frost effect (WASH)  
Stroboscopic effects motorised focus  
Electronic dimmer variable from 0 to 100%  
DMX mode: 25 channels  
Drop-down menu display  
Amplitude: 540° pan - 270° tilt  
Power IN/OUT: Neutrik powerCON® TRUE-1  
DMX IN/OUT: XLR 3+5pin  
Power supply: AC 100/230V - 50/60Hz

180W CW LED source  
Linear zoom from 6 to 21° (Beam to Spot)  
Light power: 33000 lux at 5m (6°)  
8-facet circular rotating prism  
6-facet linear rotating prism  
wheel with 9 rotating gobos + open  
wheel with 12 fixed gobos + 3 reducers  
wheel with 10 dichroic colours + open  
Progressive Frost filter  
Wash function going from 34° to 60°  
Stroboscope from 1 to 25 flashes / second  
motorised focus  
Electronic dimmer variable from 0 to 100%  
DMX mode: 17,19 or 20 channels  
Drop-down menu display  
Amplitude: 540° or 630° pan - 270° tilt  
Power consumption: 305W  
Power supply: AC 100/230V - 50/60Hz  
Dimensions: 369x288x583 mm  
Net weight: 18 Kg

# FUSION180

La lyre hybride 3 en 1\*

\*3-in-1 hybrid moving head



by **Contest**





# MOVING HEADS



## BTX-BEAM 5R

Ultra powerful moving head based on the legendary Philips MSD Platinum 5R lamp!

Code : B04353



## SWORD5R

BEAM moving head with Philips© MSD PLATINUM 5R lamp

Code : H10409



## BTX-BEAM 2R

Ultra powerful moving head based on the legendary Philips MSD Platinum 2R lamp!

Code : B04372



Philips MSD Platinum 5R source  
 Light power: 200000 lux at 10m  
 Beam opening: 1 to 3.5°  
 Stroboscopic effects  
 Motorised focus  
 Frost filter  
 8-facet rotating prism wheel with 17 gobos + open wheel with 14 dichroic colours + open  
 Variable dimmer from 0 to 100%  
 DMX mode: 19 channels  
 Drop-down menu display to assign and select different modes  
 Amplitude: 540° pan - 270° tilt  
 Power consumption: 290 W maximum  
 Power supply: AC 100/230V - 50/60Hz  
 Dimensions: 415 x 343 x 487 mm  
 Net weight: 20 Kg

Philips MSD Platinum 5R source  
 Light power: 770000 lux at 5m  
 Beam opening: 3.5°  
 Strobe, pulse effect and random strobe  
 Motorised focus  
 Frost filter  
 8-facet rotating prism wheel with 17 gobos + open wheel with 14 dichroic colours + open  
 Variable dimmer from 0 to 100%  
 DMX mode: 1, 12 and 16 channels  
 Synchronised shows (internal microphone)  
 Master / Slave mode  
 Drop-down menu display to assign and select different modes  
 Amplitude: 540° pan - 270° tilt  
 Power consumption: 270 W maximum  
 Power supply: AC 100/230V - 50/60Hz  
 Dimensions: 500 x 394 x 525 mm  
 Net weight: 18 Kg

Philips MSD Platinum 2R source  
 Light power: 338.400 lux at 5m  
 Beam opening: 2.8°  
 Motorised focus  
 Stroboscopic effects  
 8-facet rotating prism wheel with 17 gobos + open wheel with 14 dichroic colours + open  
 Variable dimmer from 0 to 100%  
 DMX mode: 14 and 16 channels  
 Drop-down menu display to assign and select different modes  
 Amplitude: 540° pan - 270° tilt  
 Power consumption: 250 W  
 Power supply: AC 100/230V - 50/60Hz  
 Dimensions: 311 x 256 x 476 mm  
 Net weight: 15 Kg



## CASE FOR 2x BTX-BEAM 5R

Flight case for 2 x BriteQ BTX-BEAM 5R

Code : B03239



## CASE FOR 4x BTX-BEAM 2R

Flight case for 4x BTX-BEAM 2R

Code : B03248





### RAY1R

Beam moving head with HRI 100W OSRAM® lamp

Code : H10410



### BT-TRACKER

Super compact but very powerful moving head SIRIUS HRI-100 lamp from OSRAM!

Code : B04387



### Thunder-80

Concentrated light beam moving head 80WLe

Code : H10176



Osram SIRIUS HRI 100W source  
 Light power: 307200 lux at 5m  
 Beam opening: 3°  
 Strobe, pulse effect and random strobe  
 8-facet rotating prism  
 wheel with 15 gobos + open  
 wheel with 14 dichroic colours + open  
 Variable dimmer from 0 to 100%  
 DMX mode: 1.10 and 14 channels  
 Synchronised shows (internal microphone)  
 Master / Slave mode  
 Drop-down menu display to assign and select different modes  
 Amplitude: 540° pan - 270° tilt  
 Power consumption: 194.5 W maximum  
 Power supply: AC 100/230V - 50/60Hz  
 Dimensions: 279 x 225 x 387 mm  
 Net weight: 9.2 Kg

Osram SIRIUS HRI 100W source  
 Light power: 307200 lux at 5m  
 Beam opening: 3°  
 Strobe, pulse effect and random strobe  
 8-facet rotating prism  
 wheel with 10 gobos + 4 reducers + open  
 wheel with 14 dichroic colours + open  
 Variable dimmer from 0 to 100%  
 DMX mode: 5 and 12 channels  
 Synchronised shows (internal microphone)  
 Master / Slave mode  
 Drop-down menu display to assign and select different modes  
 Amplitude: 540° pan - 270° tilt  
 Power consumption: 194.5 W maximum  
 Power supply: AC 100/230V - 50/60Hz  
 Dimensions: 279 x 225 x 401 mm  
 Net weight: 9.2 Kg

80W CW LED source  
 Beam opening: 6°  
 Strobe, pulse effect and random strobe  
 3-facet rotating prism  
 wheel with 7 rotating gobos + open  
 wheel with 8 dichroic colours + open  
 Electronic dimmer variable from 0 to 100%  
 DMX mode: 1-11 channels  
 Synchronised shows (internal microphone)  
 Simplified control (EASY-2 compatible)  
 Master / Slave mode  
 Drop-down menu display to assign and select different modes  
 Amplitude: 540° pan - 270° tilt  
 Power consumption: 155W max.  
 Power supply: AC 100/230V - 50/60Hz  
 Dimensions: 292x185x461mm  
 Net weight: 8 Kg



### FLY-RAY1R-HE-Z0120Zx4

Flight case for 4 RAY1R or 4 HEZ0120Z

Code : H10610



### CASE for 4x BT-TRACKER

Flight case for 4x BT-TRACKER.

Code : B03264



### FLY2CLUB-S1

Flight case for Typhoon/Thunder/Cyclone/Wave

Code : H10247





# MOVING HEADS



## BTX-HAWK

Very bright moving head controlled by a powerful 180 W LED module!

Code : B04398



180W CW LED source  
 motorised focus  
 Beam opening: 12°  
 3-facet rotating prism + linear prism wheel with 7 rotating gobos + open wheel with 9 fixed gobos + open wheel with 7 dichroic colours + open Frost filter  
 Electronic dimmer variable from 0 to 100%  
 DMX mode: 11 or 13 channels  
 Synchronised shows (internal microphone)  
 Master / Slave mode  
 Drop-down menu display to assign and select different modes  
 Wireless DMX: WTR-DMX dongle (optional)  
 Power consumption: 230W  
 Power supply: AC 100/230V - 50/60Hz  
 Dimensions: 393x558x288 mm  
 Net weight: 16.5 Kg



## Cyclone-120R

Spot moving head with 120 W LED and multi-effects

Code : H10402



120W CW LED source  
 manual focus  
 Beam opening: 15°  
 Strobe, pulse effect and random strobe  
 3-facet rotating prism wheel with 6 rotating gobos + open wheel with 8 dichroic colours + open Electronic dimmer variable from 0 to 100%  
 DMX mode: 1-16 channels  
 Synchronised shows (internal microphone)  
 Simplified control (EASY-2 compatible)  
 Master / Slave mode  
 Drop-down menu display to assign and select different modes  
 Amplitude: 540° pan - 270° tilt  
 Power consumption: 200W max.  
 Power supply: AC 100/230V - 50/60Hz  
 Dimensions: 292x169x425mm  
 Net weight: 8 Kg



## BT-METEOR

Compact and extremely bright LED moving head

Code : B04384



100W CW LED source  
 motorised focus  
 Beam opening: from 12° to 16°  
 Strobe, pulse effect and random strobe  
 3-facet rotating prism wheel with 6 rotating gobos + open wheel with 8 dichroic colours + open Electronic dimmer variable from 0 to 100%  
 DMX mode: 5, 11 or 14 channels  
 Synchronised shows (internal microphone)  
 Master / Slave mode  
 Drop-down menu display to assign and select different modes  
 Wireless DMX: WTR-DMX dongle (optional)  
 Power consumption: 160W  
 Power supply: AC 100/230V - 50/60Hz  
 Dimensions: 290x180x435mm  
 Net weight: 8.75 Kg



## Cyclone-80

Spot moving head with 80W LED and multi-effects

Code : H10175



80W CW LED source  
 manual focus  
 Beam opening: 15°  
 Strobe, pulse effect and random strobe  
 3-facet rotating prism wheel with 7 gobos + open wheel with 8 dichroic colours + open Electronic dimmer variable from 0 to 100%  
 DMX mode: 1-15 channels  
 Synchronised shows (internal microphone)  
 Simplified control (EASY-2 compatible)  
 Master / Slave mode  
 Drop-down menu display to assign and select different modes  
 Amplitude: 540° pan - 270° tilt  
 Power consumption: 150W max.  
 Power supply: AC 100/230V - 50/60Hz  
 Dimensions: 292x169x425mm  
 Net weight: 8 Kg



## MOVING HEAD CASE 1

Flight case for 2x BT-METEOR, BT-70LS, BT-BEAM70

Code : B03255



## CASE for 2x BTX-HAWK

Flight case for 2x Briteq BTX-HAWK

Code : B03263





### Blast-60

Spot moving head with 60W LED

Code : H10312



### DYNASPOT

LED spot moving head with compact and bright 12° beam

Code : B04053



### CLUBSPOT

Compact moving head with 35W LED

Code : B05506

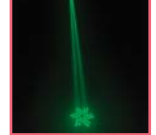

60W CW LED source  
Manual focus  
Beam opening from 14°  
Strobe, pulse effect and random strobe  
3-facet rotating prism  
Wheel with 6 rotating gobos + open  
Wheel with 8 dichroic colours + open  
Electronic dimmer variable from 0 to 100%  
DMX mode: 1, 8 or 12 channels  
Synchronised shows (internal microphone)  
Simplified control [EASY-2 compatible]  
Master / Slave mode  
Drop-down menu display to assign and select different modes  
Amplitude: 540° pan - 270° tilt  
Power consumption: 70 W maximum  
Power supply: AC 100/230V - 50/60Hz  
Dimensions: 212 x 174 x 352 mm  
Net weight: 5.3 Kg

10W CW LED source  
Manual focus  
Beam opening from 12°  
Stroboscopic effects  
Wheel with 6 fixed gobos + open  
Wheel with 8 dichroic colours + open  
Electronic dimmer variable from 0 to 100%  
DMX mode: 5, 8 or 10 channels  
Infrared remote control  
Synchronised shows (internal microphone)  
Master / Slave mode  
Wireless DMX: WTR-DMX dongle (optional)  
Drop-down menu display to assign and select different modes  
Amplitude: 540° pan - 270° tilt  
Power consumption: 70 W maximum  
Power supply: AC 100/230V - 50/60Hz  
Dimensions: 170 x 170 x 200 mm  
Net weight: 2.96 Kg

35W CW LED source  
Manual focus  
12° opening  
Stroboscopic effects  
Wheel with 7 fixed gobos + open  
Wheel with 7 dichroic colours + open  
Electronic dimmer variable from 0 to 100%  
DMX mode: 5, 9 or 11 channels  
Wireless DMX: WTR-DMX dongle (optional)  
Synchronised shows (internal microphone)  
Master / Slave mode  
Drop-down menu display to assign and select different modes  
Amplitude: 540° pan - 270° tilt  
DMX IN / OUT by XLR 3-pin plugs  
POWER IN / OUT by IEC plugs  
Power consumption: 60W maximum  
Power supply: AC 100/230V - 50/60Hz  
Dimensions: 284,5 x 205 x 149 mm  
Net weight: 3.5 Kg



### LIGHT EFFECT CASE 4

Flight case for 2x LYNX, 2x BT-20LS, 2x BT-30FC or 2x BT-W12L10 ZOOM

Code : B03225



### FLY4Hezo300ZR

Flight case for 4x HEZO300ZR

Code : H10736

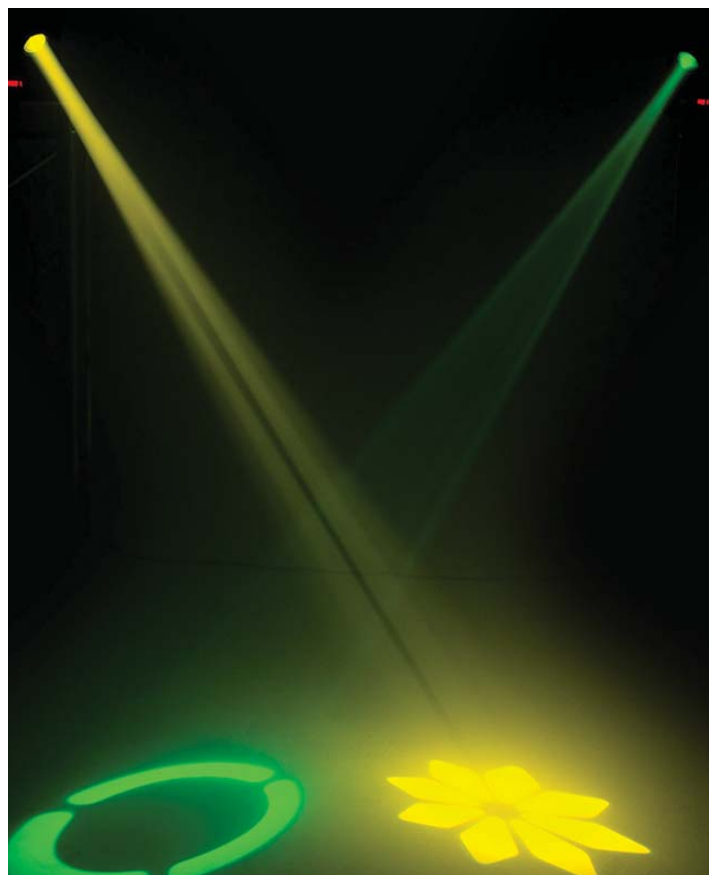

# MOVING HEADS



## HEZO300ZR

Moving head with 19 15W 4-in-1 RGBW LEDs with Zoom

Code: H10710



19 15W RGBW LED sources  
Opening from 10° to 60° by motorised lighted zoom: 9030 LUX at 5m at 10°  
Programmable white balance  
Colour preset, Colour macro Strobe, pulse effect and random strobe  
Electronic dimmer variable from 0 to 100%  
Motorised zoom from 10° to 60°  
Independent control of three colour zones (outer ring, inner ring and central point)  
DMX mode: 1, 22 or 30 channels  
Synchronised shows (internal microphone)  
Master / Slave mode  
Drop-down menu display to assign and select different modes  
Amplitude: 540° pan - 270° tilt  
DMX IN / OUT by XLR 3/5-pin plugs  
POWER IN / OUT by Powercon plugs  
Power consumption: 340W maximum  
Power supply: AC 100/230V - 50/60Hz  
Dimensions: 325 x 222 x 393 mm  
Net weight: 9 Kg



## BT-ORBIT

Big brother of the very popular BT-W19L10 ZOOM with output increased by 65%.

Code : B04423



19 15W RGBW LED sources  
Opening from 10° to 60° by motorised lighted zoom: 8400 LUX at 5m at 10°  
Programmable white balance  
Colour preset, Colour macro Strobe, pulse effect and random strobe  
Electronic dimmer variable from 0 to 100%  
Wireless DMX: WTR-DMX dongle (optional)  
Independent control of three colour zones (outer ring, inner ring and central point)  
DMX mode: 14 or 27 channels  
Drop-down menu display to assign and select different modes  
Amplitude: 540° pan - 270° tilt  
DMX IN / OUT by XLR 3/5-pin plugs  
POWER IN / OUT by Powercon plugs  
Power consumption: 290W maximum  
Power supply: AC 100/230V - 50/60Hz  
Dimensions: 395 x 325 x 225 mm  
Net weight: 9 Kg



## BT-W19L10 ZOOM

Powerful and compact wash moving head

Code : B04359



19 10W RGBW LED sources  
Opening from 10° to 60° by motorised lighted zoom: 5100 LUX at 5m at 10°  
Programmable white balance  
Colour preset, Colour macro Strobe, pulse effect and random strobe  
Electronic dimmer variable from 0 to 100%  
DMX mode: 14 channels  
Drop-down menu display to assign and select different modes  
Amplitude: 540° pan - 270° tilt  
DMX IN / OUT by XLR 3/5-pin plugs  
POWER IN / OUT by Powercon plugs  
Power consumption: 245W maximum  
Power supply: AC 100/230V - 50/60Hz  
Dimensions: 325 x 188 x 396 mm  
Net weight: 9.2 Kg



## HEZO120Z

Wash moving head 12 x 10 W RGBW OSRAM®

Code : H10408

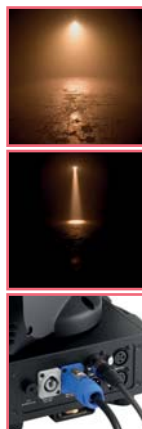

12 10W RGBW LED sources  
Opening from 10° to 60° by motorised lighted zoom: 2600 LUX at 5m at 10°  
Programmable white balance  
Colour preset, Colour macro Strobe, pulse effect and random strobe  
Electronic dimmer variable from 0 to 100%  
Motorised zoom from 10° to 60°  
DMX mode: 1-30 channels  
Synchronised shows (internal microphone)



## MOVING HEAD CASE 2

Flight case for 4 BT-Orbit / BT-W19 moving head

Code : B03272



Master / Slave mode  
Drop-down menu display to assign and select different modes  
Amplitude: 540° pan - 270° tilt  
DMX IN / OUT by XLR 3/5-pin plugs  
POWER IN/OUT with Powercon plugs  
Power consumption: 198W maximum  
Power supply: AC 100/230V - 50/60Hz  
Dimensions: 263 x 183 x 340 mm  
Net weight: 7.5 Kg



### NINJA7i

Moving head with 7 4-colour 15W LEDs

Code : H10405



7 15W RGBW LED sources  
Opening from 10° to 20°  
Light: 4400 LUX at 5m at 10°  
Colour preset, Colour macro Strobe, pulse effect and random strobe  
Electronic dimmer variable from 0 to 100%  
Independent control of two colour zones (outer ring and central point)  
DMX mode: 16-25 channels  
Synchronised shows (internal microphone)  
Master / Slave mode  
Drop-down menu display to assign and select different modes  
Amplitude: 540° or 630° pan - 270° tilt  
Infinite PAN and TILT rotation  
DMX IN / OUT by XLR 3-pin plugs POWER IN / OUT by Powercon plugs  
Power consumption: 130W maximum  
Power supply: AC 100/230V - 50/60Hz  
Dimensions: 319 x 226 x 243 mm  
Net weight: 5 Kg

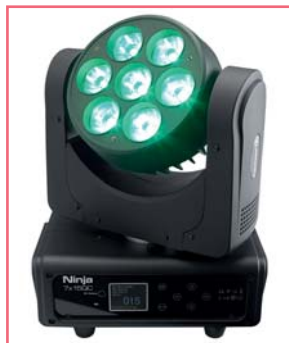

### Ninja-7x15QC

Moving head with 7 4-colour 15W LEDs with diffuser filter and concentrator

Code : H10075



7 15W RGBW LED sources  
Source opening of 11° + Frost filter 20°  
Light: 4400 LUX at 5m at 10°  
Colour preset, Colour macro Strobe, pulse effect and random strobe  
Electronic dimmer variable from 0 to 100%  
Independent control of two colour zones (outer ring and central point)  
DMX mode: 15-21 channels  
Synchronised shows (internal microphone)  
Master / Slave mode  
Drop-down menu display to assign and select different modes  
Amplitude: 540° or 630° pan - 270° tilt  
DMX IN / OUT by XLR 3-pin plugs POWER IN / OUT by Powercon plugs  
Power consumption: 140W maximum  
Power supply: AC 100/230V - 50/60Hz  
Dimensions: 319 x 226 x 243 mm  
Net weight: 5.5 Kg



### BT-W07L12

Wash moving head 7 x 12W RGBW

Code : B04358



7 12W RGBW LED sources  
10° opening  
Independent control of four zones  
Light: 2300 LUX at 5m at 10°  
Colour preset, Colour macro Strobe, pulse effect and random strobe  
Electronic dimmer variable from 0 to 100%  
DMX mode: 1-28 channels  
Synchronised shows (internal microphone)  
Master / Slave mode  
Drop-down menu display to assign and select different modes  
Amplitude: 540° or 630° pan - 270° tilt  
DMX IN / OUT by XLR 3-pin plugs POWER IN / OUT by Powercon plugs  
Power consumption: 126W maximum  
Power supply: AC 100/230V - 50/60Hz  
Dimensions: 322 x 266 x 154 mm  
Net weight: 6.2 Kg



### BT-W36L3

Wash moving head 36 x 3W (12R-12G-12B)

Code : B04344



36 3W LED sources (12 Red + 12 Green + 12 Blue)  
12.5° opening  
Light: 5050 LUX at 5m at 12.5°  
Colour preset, Colour macro Strobe, pulse effect and random strobe  
Electronic dimmer variable from 0 to 100%  
DMX mode: 1-15 channels  
Synchronised shows (internal microphone)



### CASE FOR 4x BT-W36L3 / BT-W07L12

Flight case for 4x BT-W36L3 or BT-W07L12

Code : B03235



Master / Slave mode  
Drop-down menu display to assign and select different modes  
Amplitude: 540° or 630° pan - 270° tilt  
DMX IN / OUT by XLR 3-pin plugs POWER IN / OUT by Powercon plugs  
Power consumption: 150W maximum  
Power supply: AC 100/230V - 50/60Hz  
Dimensions: 267 x 167 x 282 mm  
Net weight: 5.8 Kg



### Fly4Ninja-S1

Flight case for 4 Ninja-7x15QC moving heads

Code : H10076





# MOVING HEADS



## TORNADO 7

Wash moving head 7 x 15W RGBW

Code : B04376



7 15W RGBW LED sources  
6° opening  
Light: 4400 LUX at 5m at 10°  
Colour preset, Colour macro Strobe, pulse effect and random strobe  
Electronic dimmer variable from 0 to 100%  
Independent control of four zones  
DMX mode: 17 and 34 channels  
Synchronised shows (internal microphone)  
Master / Slave mode  
Drop-down menu display to assign and select different modes  
Amplitude: 360° or 720° pan - 270° tilt  
Infinite PAN and TILT rotation  
DMX IN / OUT by XLR 3-pin plugs POW-ER IN by cord + 16A plug  
Power consumption: 170W maximum  
Power supply: AC 100/230V - 50/60Hz  
Dimensions: 296 x 224 x 224 mm  
Net weight: 4.7 Kg



## STRIKER

LED spot (10°-30W-white) and wash (6 x 8W RVBW) moving head

Code : B04190



Spot 30W CW LED sources  
Wash 6 8W RGBW LED sources  
Beam opening 10° (Spot)  
Motorised focus  
wheel with 7 fixed gobos + open  
wheel with 7 dichroic colours + open  
Electronic dimmer variable from 0 to 100%  
Stroboscopic effects  
DMX mode: 5 or 19 channels  
Wireless DMX: WTR-DMX dongle (optional)  
Synchronised shows (internal microphone)  
Master / Slave mode  
Drop-down menu display to assign and select different modes  
Amplitude: 540° pan - 270° tilt  
DMX IN / OUT with 3-pin plugs  
POWER IN by IEC plug + 16A plug  
Power consumption: 95W max.  
Power supply: AC 100/230V - 50/60Hz  
Dimensions: 150x230x330mm  
Net weight: 4.53 Kg



## BT-W30FC Mk2

Wash moving head 3 x 10W RGBW

Code : B04371



3 10W RGBW LED sources  
25° opening  
Strobe, pulse effect and random strobe  
Electronic dimmer variable from 0 to 100%  
DMX mode: 9 or 16 channels  
Synchronised shows (internal microphone)  
Master / Slave mode  
CA8 compatible (option)  
Drop-down menu display to assign and select different modes  
Amplitude: 540° pan - 270° tilt  
DMX IN / OUT by XLR 3-pin plugs POW-ER IN by IEC plug + 16A plug  
Power consumption: 57.4W maximum  
Power supply: AC 100/230V - 50/60Hz  
Dimensions: 272 x 231 x 248 mm  
Net weight: 6 Kg



## CLUBWASH

Wash moving head 7 x 12W RGBWAUV

Code : B05505



7 12W RGBWAUV LED sources  
25° opening  
Stroboscopic effects  
Electronic dimmer variable from 0 to 100%  
DMX mode: 5, 9 or 15 channels  
Wireless DMX: WTR-DMX dongle (optional)  
Synchronised shows (internal microphone)  
Master / Slave mode  
CA8 compatible (option)

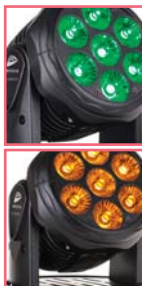

## CASE for 4x STRIKER

Flight case for 4x STRIKER

Code : B03267



Drop-down menu display to assign and select different modes  
Amplitude: 160° pan - 90° tilt  
DMX IN / OUT by XLR 3-pin plugs POW-ER IN / OUT by PowerCON plugs  
Power consumption: 90W maximum  
Power supply: AC 100/230V - 50/60Hz  
Dimensions: 322.4 x 266.5 x 154 mm  
Net weight: 3 Kg

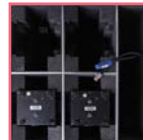

## CASE for 4x TORNADO 7

Flight case for 4x TORNADO 7

Code : B03247







### FLAG25i

Moving head with 5x5 15W RGBW LEDs

Code : H10406



### BEAM WIZARD5x5

Moving head with 5x5 15W RGBW LEDs

Code : B04417



### ROTOR7i

Motorised bar with 7 15W RGBW LEDs

Code : H10407



25 15W RGBW [5 x 5] LED sources  
4° opening per lens  
Infinite PAN and TILT rotation  
Light: 29700 LUX at 5m  
Colour Preset and Macro  
Patterns: letters, digits and figures with customisable colours  
Automatic or musical programmes  
Strobe, pulse effect and random strobe  
Electronic dimmer variable from 0 to 100%  
DMX mode: 16, 21 and 117 channels  
Ethernet port: Art-NET/ KlingNET™  
Drop-down menu display to assign and select different modes  
Amplitude: 630° pan - 270° tilt  
DMX IN / OUT by XLR 3/5-pin plugs  
POWER IN / OUT by Powercon plugs  
Ethernet IN/OUT by RJ45  
Power consumption: 420W maximum  
Power supply: AC 100/230V - 50/60Hz  
Dimensions: 583 x 481 x 352 mm  
Net weight: 18.6 Kg

25 15W RGBW [5 x 5] LED sources  
4° opening per lens  
Infinite PAN and TILT rotation  
Light: 29700 LUX at 5m  
Colour Preset and Macro  
Patterns: letters, digits and figures with customisable colours  
Automatic or musical programmes  
Strobe, pulse effect and random strobe  
Electronic dimmer variable from 0 to 100%  
DMX mode: 12, 18, 110 and 116 channels  
Ethernet port: Art-NET  
Drop-down menu display to assign and select different modes  
Amplitude: 630° pan - 270° tilt  
DMX IN / OUT by XLR 3/5-pin plugs  
POWER IN / OUT by Powercon plugs  
Ethernet IN/OUT by RJ45  
Power consumption: 420W maximum  
Power supply: AC 100/230V - 50/60Hz  
Dimensions: 583 x 481 x 352 mm  
Net weight: 18.6 Kg

7 15W RGBW LED sources  
4° opening per lens  
Infinite PAN and TILT rotation  
Light: 8100 LUX at 5m  
Colour Preset and Macro  
Patterns: letters, digits and figures with customisable colours  
Automatic or musical programmes  
Strobe, pulse effect and random strobe  
Electronic dimmer variable from 0 to 100%  
DMX mode: 15, 20 and 44 channels  
Ethernet port: Art-NET/ KlingNET™  
Drop-down menu display to assign and select different modes  
Amplitude: 630° pan - 270° tilt  
DMX IN / OUT by XLR 3/5-pin plugs  
POWER IN / OUT by Powercon plugs  
Ethernet IN/OUT by RJ45  
Power consumption: 133W maximum  
Power supply: AC 100/230V - 50/60Hz  
Dimensions: 575 x 257 x 296 mm  
Net weight: 9.6 Kg



### FLY2FLAG25i

Flight case for 2 FLAG25i

Code : H10428



### FLY2ROTOR7i

Flight case for 2 ROTOR7i

Code : H10429



### CASE FOR BEAM WIZARD5x5

Flight case for 2x BT-BEAM WIZARD

Code : B03256



# MOVING HEADS



## DART90iZOOM

Moving head with 90W RGBW LED with zoom from 4° to 44° and continuous PAN and TILT movements

Code : H10594



90 W RGBW COB LED source  
Opening from 4° to 44° by motorised zoom  
Infinite PAN and TILT rotation  
Light: 3800 LUX at 5m at 4°  
Colour Preset and Macro  
Automatic or musical programmes  
Strobe, pulse effect and random strobe  
Electronic dimmer variable from 0 to 100%  
DMX mode: 13, 18 and 20 channels  
Ethernet port: Art-NET/ KlingNET™  
Drop-down menu display to assign and select different modes  
Amplitude: 540° or 630° pan - 270° tilt  
DMX IN / OUT by XLR 3-pin plugs POWER IN / OUT by Powercon plugs  
Ethernet IN/OUT by RJ45  
Power consumption: 120W maximum  
Power supply: AC 100/230V - 50/60Hz  
Dimensions: 304 x 236 x 186 mm  
Net weight: 5.2 Kg



## BEAM FURY-1

Moving head with 60W RGBW LED and continuous rotation

Code : B04394



60 W RGBW COB LED source  
4° opening [10° and 45° filters included]  
Infinite PAN and TILT rotation  
Light: 5280 LUX at 5m at 4°  
Colour Preset and Macro  
Automatic or musical programmes  
Strobe, pulse effect and random strobe  
Electronic dimmer variable from 0 to 100%  
DMX mode: 16 and 18 channels  
Drop-down menu display to assign and select different modes  
Amplitude: 540° or 630° pan - 270° tilt  
DMX IN / OUT by XLR 3/5-pin plugs  
POWER IN / OUT by Powercon plugs  
Power consumption: 80W maximum  
Power supply: AC 100/230V - 50/60Hz  
Dimensions: 304 x 236 x 186 mm  
Net weight: 5.3 Kg



## DART60i

Moving head with 60W RGBW LED and continuous rotation

Code : H10490



60 W RGBW COB LED source  
4° opening [10° and 45° filters included]  
Infinite PAN and TILT rotation  
Light: 5280 LUX at 5m at 4°  
Colour Preset and Macro  
Automatic or musical programmes  
Strobe, pulse effect and random strobe  
Electronic dimmer variable from 0 to 100%  
DMX mode: 16 and 18 channels  
Drop-down menu display to assign and select different modes  
Amplitude: 540° or 630° pan - 270° tilt  
DMX IN / OUT by XLR 3/5-pin plugs  
POWER IN / OUT by Powercon plugs  
Power consumption: 80W maximum  
Power supply: AC 100/230V - 50/60Hz  
Dimensions: 304 x 236 x 186 mm  
Net weight: 5.3 Kg



## CASE for 6x BEAM FURY-1

Flight case for 6x BEAM FURY-1

Code : B03265



## FLY-DARTx6

Flight case for 6 DART60i or DART60iZoom

Code : H10611



# SCANNERS



**VICTORYSCAN Mk2 LED**  
Scanner effect CREE 60 WATTS LED.

Code : B04054



60W CW LED source  
manual focus  
Beam opening: 17°  
wheel with 6 fixed gobos + open  
wheel with 8 dichroic colours + open  
Electronic dimmer variable from 0 to 100%  
DMX mode: 1, 7 or 8 channels  
Synchronised shows (internal microphone)  
Simplified control  
CA8 / RF-8SET compatible  
Master / Slave mode  
Drop-down menu display to assign and  
select different modes  
Power consumption: 105 W maximum  
Power supply: AC 100/230V - 50/60Hz  
Dimensions: 472 x 208 x 264 mm  
Net weight: 7.32 Kg





**DYNAMO 250**  
Attractive and compact scanner

Code : B04020



ELC250W/24V lamp source  
manual focus  
Beam opening: 13°  
Wheel with 10 multicolour gobos + open  
DMX mode: 4 channels  
Synchronised shows (internal microphone)  
Simplified control  
CA8 compatible  
Master / Slave mode  
Power supply: AC 100/230V - 50/60Hz  
Dimensions: 385 x 170 x 120 mm  
Net weight: 4.4 Kg





**DYNABARREL**  
LED effect with rotating mirror

Code : B04187



10W RGBW LED source  
manual focus  
DMX mode: 1 or 9 channels  
Synchronised shows (internal microphone)  
Simplified control: CA8 compatible  
Master / Slave mode  
DMX IN / OUT by XLR 3-pin plugs POW-  
ER IN / OUT by IEC plugs  
Power supply: AC 100/230V - 50/60Hz  
Dimensions: 331 x 170 x 120 mm  
Net weight: 2.95 Kg

**QUADROLL**  
Roller effect with 8W R/G/B/W LEDs

Code : H10290



4 R/G/B/W LED 8 W sources  
DMX mode: 1,3 and 10 channels  
Synchronised shows (internal microphone)  
Simplified control: EASY-2 compatible  
Master / Slave mode  
Drop-down menu display to assign and  
select different modes  
DMX IN / OUT by XLR 3-pin plugs POW-  
ER IN / OUT by IEC plugs  
Power consumption: 40 W maximum  
Power supply: AC 100/230V - 50/60Hz  
Dimensions: 479 x 247 x 132 mm  
Net weight: 2.2 Kg



**LIGHT EFFECT CASE 3**  
Flight case for 2x LED CLUBSCAN or 2x  
DYNAMO scan

Code : B03223



**LIGHT EFFECT CASE 7**  
For The Winner II, Led Victoryscan Led  
Spinner,...

Code : B03233



# MOVING HEAD COMPARISON

## Hybrid Beam/Spot/Wash moving heads

REF	NAME	Brand	Source	Auto Programme	CMY	Colour wheel	Rotating interchangeable gobos	Fixed gobos	Rotating circular prism
H10295	EVORA-Flex15R	Contest	15R 300W	yes	yes	6 colours	8 gobos	14 gobos	3 facets
B04378	BTX-TITAN	Briteq	HRI280 280W	no	no	13 colours (CTO + CTB)	9 gobos	14 gobos	combinable 8 facets
B04428	BTX-Saturn	Briteq	270W LED	no	yes	9 colours (CTO + CTB + UV)	7 gobos	9 gobos	3 facets
H10661	FUSION180	Contest	180W LED	yes	-	10 colours	9 gobos	15 gobos	8 facets

## Beam moving heads

REF	NAME	Brand	Source	Beam Opening	Auto Programme	PAN / TILT Macro	Colour wheel	Gobos	Rotating circular prism
B04353	BTX-BEAM 5R	Briteq	5R 189W	1° - 3.8°	no	yes	14 colours	17 gobos	8 facets
H10409	SWORD5R	Contest	5R 189W	3.5°	yes + sound	yes	14 colours	17 gobos	8 facets
B04372	BTX-BEAM 2R	Briteq	2R 132W	2.8°	no	yes	14 colours	17 gobos	8 facets
H10410	RAY1R	Contest	HRI-100 100W	3°	yes + sound	yes	14 colours	15 gobos	8 facets
B04387	BT-TRACKER	Briteq	HRI-100 100W	3°	sound	-	14 colours	15 gobos	8 facets
H10176	Thunder-80	Contest	80W LED	6°	yes + sound	yes	8 colours	7 rotating gobos	-

## Spot moving heads

REF	NAME	Brand	Source	Beam Opening	USB Port for B04645 WiFi dongle	Auto Programme	PAN / TILT Macro	Colour wheel	Rotating interchangeable gobos
B04398	BTX-HAWK	Briteq	180W LED	12°	yes	yes	-	7 colours	7 gobos
H10402	Cyclone120R	Contest	120W LED	15°	-	yes	yes	8 colours	6 gobos
B04384	BT-METEOR	Briteq	100W LED	12° to 16°	yes	yes	-	8 colours	6 gobos
H10175	Cyclone-80	Contest	80W LED	15°	-	yes	yes	8 colours	-
H10312	BLAST-60	Contest	60W LED	14°	-	yes	yes	8 colours	6 gobos
B05506	CLUBSPOT	JB Systems	35W LED	12°	yes	yes	-	7 colours	-
B04053	DYNASPOT	JB Systems	10W LED	12°	yes	yes + ir remote	-	7 colours	-

## Wash / Beam LED moving heads

REF	NAME	Brand	LED source	Beam Opening	Continuous Pan/Tilt rotation	USB Port for B04645 WiFi dongle	Auto Programme	PAN / TILT Macro	Colour wheel
H10710	HEZO300ZR	Contest	19x15W RGBW	10° to 60°	-	-	yes	yes	-
B04423	BT-ORBIT	Briteq	19x15W RGBW	10° to 60°	-	yes	-	-	-
B04359	BT-W19L10 ZOOM	Briteq	19x10W RGBW	10° to 60°	-	-	-	-	-
H10408	HEZO120Z	Contest	12x10W RGBW	10° to 60°	-	-	yes	yes	-
H10405	Ninja7i	Contest	7x15W RGBW	11°-20°	yes	-	yes	-	-
H10075	Ninja-7x15QC	Contest	7x15W RGBW	9°-11°-20°	-	-	yes	-	-
B04358	BT-W07L12	Briteq	7x12W RGBW	10°	-	-	yes	yes	-
B04344	BT-W36L3	Briteq	12xR-12xG-12xB 3W	12.5°	-	-	yes	yes	-
B04376	TORNADO 7	Briteq	7x15W RGBW	6°	yes	-	yes	-	-
B04371	BT-W30FC Mk2	Briteq	3x10W RGBW	25°	-	-	yes	yes	-
B05505	CLUBWASH	JB Systems	7x12W RGBWA+UV	25°	-	yes	yes	-	-
B04190	STRIKER	JB Systems	30W White 6x8W RGBW	10° spot	-	yes	yes	yes	7 colours

## LED effect moving heads

REF	NAME	Brand	LED source	Beam Opening	Continuous Pan/Tilt rotation	Art-NET compatibility	Auto Programme	Multi zones pixel	Motorised zoom
H10406	FLAG25i	Contest	25x15W QC	25x 4.5°	yes	yes RJ45 IN/OUT	yes	25	-
B04417	BEAM WIZARD5x5	Briteq	25x15W QC	25x 4.5°	yes	yes RJ45 IN/OUT	yes	25	-
H10407	ROTOR7i	Contest	7x15W QC	7x 4°	yes	yes RJ45 IN/OUT	yes	7	-
H10594	DART90i ZOOM	Contest	90W	4° to 44°	yes	yes RJ45 IN/OUT	yes	-	yes
B04394	BEAM FURY-1	Briteq	60W	4°-10°45°	yes	-	-	-	-
H10490	DART60i	Contest	60W	4°-10°45°	yes	-	yes	-	-

Linear rotating prism	Iris	Frost	Zoom Beam - Spot	Focus	Number of DMX channels	Battery for adjusting with power off	DMX XLR	Power supply	Weight	Flight case compatible
-	yes	Linear	6° to 28°	yes	21-23-34	yes	3 and 5 pin	Powercon IN	19Kg	H10343
combinable 6 facets	no	Linear	2.7° to 23°	yes	16-24-25	yes	3 and 5 pin	Powercon IN - OUT	22Kg	B03251
-	yes	Linear	8° to 45°	yes	25	no	3 and 5 pin	Powercon TRUE1 IN - OUT	22.7 kg	B03273
6 facets	-	Linear	6 to 21°	yes	17-19-20	yes	3 and 5 pin	Seetronic IN - OUT	18Kg	H10737

Trapezoidal rotating prism	Frost	Focus	Number of DMX channels	Battery for adjusting with power off	DMX XLR	Power supply	Weight	Flight case compatible
-	yes	yes	19	yes	3 and 5 pin	Powercon IN - OUT	20Kg	B03239
-	yes	yes	1-12-16	-	3 pin	Powercon IN - OUT	18Kg	B03239
yes	-	yes	14-16	-	3 and 5 pin	Powercon IN - OUT	15Kg	B03248
-	-	-	1-10-14	-	3 pin	Powercon IN - OUT	9.2Kg	H10610
-	-	-	5-12	-	3 pin	Powercon IN - OUT	9.7Kg	B03264
-	-	-	1-8-11	-	3 pin	IEC IN - OUT	8Kg	H10247

Fixed gobos	Rotating circular prism	Linear Prism	Frost	Focus	Number of DMX channels	Battery for adjusting with power off	DMX XLR	Power supply	Weight	Flight case compatible
9 gobos	3 facets	yes	yes	motorised	5-13-15	yes	3 and 5 pin	Powercon IN - OUT	15.5Kg	B03263
-	3 facets	-	-	manual	1-10-16	-	3 pin	IEC IN - OUT	8Kg	H10247
-	3 facets	-	-	motorised	5-11-14	-	3 pin	Powercon IN - OUT	8.75Kg	B03255
7 gobos	3 facets	-	-	manual	1-9-15	-	3 pin	IEC IN - OUT	8Kg	H10247
-	-	-	-	manual	1-8-12	-	3 pin	IEC IN - OUT	5.3Kg	H10247
7 gobos	-	-	-	manual	5-8-11	-	3 pin	IEC IN	3.5Kg	Coming soon
6 gobos	-	-	-	manual	5-8-10	-	3 pin	IEC IN - OUT	2.96Kg	-

Gobo Wheel	Multi zones pixel	Motorised Zoom / Focus	Number of DMX channels	Battery for adjusting with power off	DMX XLR	Power supply	Weight	Flight case compatible
-	3	Zoom	1-22-30	-	3 and 5 pin	Powercon IN - OUT	9Kg	H10736
-	3	Zoom	14a-14b-27	-	3 and 5 pin	Powercon IN - OUT	9.2Kg	B03272
-	-	Zoom	14a-14b	-	3 and 5 pin	Powercon IN - OUT	9.2Kg	B03272
-	-	Zoom	1-12-17	-	3 and 5 pin	Powercon IN - OUT	7.5Kg	H10610
-	2	-	16-20-25	yes	3 pin	Powercon IN - OUT	5.5Kg	H10076
-	2	-	15-17-21	yes	3 pin	Powercon IN - OUT	5.5Kg	H10076
-	4	-	1-4-9-12-16-28	-	3 pin	Powercon IN - OUT	6.4Kg	B03235
-	-	-	1-4-8-12-15	-	3 pin	Powercon IN - OUT	5.8Kg	B03235
-	4	-	17-34	-	3 pin	Power cable	4.7Kg	B03247
-	-	-	1-4-1-9-16	-	3 pin	IEC IN - OUT	4.2Kg	B03225
-	-	-	5-9-15	-	3 pin	IEC IN	3 kg	Coming soon
7 gobos	Spot / Wash	Focus	5-19	-	3 pin	IEC IN	4.5Kg	B03267

Number of DMX channels	Battery for adjusting with power off	DMX XLR	Power supply	Weight	Flight case compatible
16-21-117	yes	3 and 5 pin	Powercon IN - OUT	20Kg	H10428
12-18-110-116	yes	3 and 5 pin	Powercon IN - OUT	20Kg	B03256
15-20-44	yes	3 and 5 pin	Powercon IN - OUT	9.6Kg	H10429
13-18-20	yes	3 and 5 pin	Powercon IN - OUT	5.3Kg	H10611
12-14	yes	3 and 5 pin	Powercon IN - OUT	6.2Kg	B03265
12-17-19	yes	3 and 5 pin	Powercon IN - OUT	5.3Kg	H10611





# ANIMATION EFFECTS



## Heliptic-9x10WH

Animation projector with 3x3 white beams and continuous PAN

Code : H10311



## Heliptic-9x10QC

Animation projector with 3x3 4-colour beams and continuous PAN

Code : H10360



## Heliwave-8x10WH

Animation light bars with 2x4 white beams and continuous PAN

Code : H10293



9 10W White LED sources  
 Beam opening 6° per lens  
 Strobe, pulse effect and random strobe  
 Electronic dimmer variable from 0 to 100%  
 DMX mode: 1, 11, 16 and 15 channels  
 Synchronised shows (internal microphone)  
 Simplified control (EASY-2 compatible)  
 Master / Slave mode  
 Drop-down menu display to assign and select different modes  
 Independent rotation of each bar  
 Bar rotation over 145°  
 Continuous PAN rotation  
 DMX IN / OUT by XLR 3-pin plugs POWER IN / OUT by IEC plugs  
 Power consumption: 106W max.  
 Power supply: AC 100/230V - 50/60Hz  
 Dimensions: 429 x 347 x 208 mm  
 Net weight: 9.6 Kg

9 10W RGBW LED sources  
 Beam opening 6° per lens  
 Strobe, pulse effect and random strobe  
 Electronic dimmer variable from 0 to 100%  
 DMX mode: 1, 11, 43 and 47 channels  
 Synchronised shows (internal microphone)  
 Simplified control (EASY-2 compatible)  
 Master / Slave mode  
 Drop-down menu display to assign and select different modes  
 Independent rotation of each bar  
 Bar rotation over 145°  
 Continuous PAN rotation  
 DMX IN / OUT by XLR 3-pin plugs POWER IN / OUT by IEC plugs  
 Power consumption: 126W max.  
 Power supply: AC 100/230V - 50/60Hz  
 Dimensions: 429 x 347 x 208 mm  
 Net weight: 9.6 Kg

8 10W White LED sources  
 Beam opening 6° per lens  
 Strobe, pulse effect and random strobe  
 Electronic dimmer variable from 0 to 100%  
 DMX mode: 1, 10, 14 and 18 channels  
 Synchronised shows (internal microphone)  
 Simplified control (EASY-2 compatible)  
 Master / Slave mode  
 Drop-down menu display to assign and select different modes  
 Independent rotation of each bar  
 Bar rotation over 145°  
 Continuous PAN rotation  
 DMX IN / OUT by XLR 3-pin plugs POWER IN / OUT by IEC plugs  
 Power consumption: 106W max.  
 Power supply: AC 100/230V - 50/60Hz  
 Dimensions: 393 x 232 x 239 mm  
 Net weight: 9.6 Kg



## FLY-HELIWAVEx2

Flight case for 2 HELIWAVE

Code : H10340



## FLY-HELIPTIC

Flight case for 1 HELIPTIC

Code : H10341





### Storm-8x10QC

Moving head with double animation ramp.  
The madness of the colored multibeam

Code : H10172



### Storm-8x10WH

Moving head with double animation ramp.  
The madness of the white multibeam

Code : H10173



### Wave-8x10QC

Double motorized animation ramp. Colored  
multibeam effect.

Code : H10170

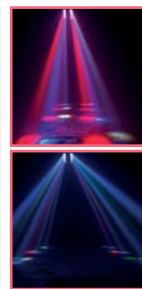

8 10W RGBW LED sources  
Beam opening 6° per lens  
Strobe, pulse effect and random strobe  
Electronic dimmer variable from 0 to 100%  
DMX mode: 1-37 channels  
Synchronised shows (internal microphone)  
Simplified control (EASY-2 compatible)  
Master / Slave mode  
Drop-down menu display to assign and  
select different modes  
Panoramic movement  
Independent rotation of each bar  
Amplitude: 540° pan - Bar rotation  
over 230°  
DMX IN / OUT by XLR 3-pin plugs POW-  
ER IN / OUT by IEC plugs  
Power consumption: 100W max.  
Power supply: AC 100/230V - 50/60Hz  
Dimensions: 414x153x376mm  
Net weight: 6.5 Kg

8 10W White LED sources  
Beam opening 6° per lens  
Strobe, pulse effect and random strobe  
Electronic dimmer variable from 0 to 100%  
DMX mode: 1-13 channels  
Synchronised shows (internal microphone)  
Simplified control (EASY-2 compatible)  
Master / Slave mode  
Drop-down menu display to assign and  
select different modes  
Panoramic movement  
Independent rotation of each bar  
Amplitude: 540° pan - Bar rotation  
over 230°  
DMX IN / OUT by XLR 3-pin plugs POW-  
ER IN / OUT by IEC plugs  
Power consumption: 100W max.  
Power supply: AC 100/230V - 50/60Hz  
Dimensions: 414x153x376mm  
Net weight: 6.5 Kg

8 10W RGBW LED sources  
Beam opening 6° per lens  
Strobe, pulse effect and random strobe  
Electronic dimmer variable from 0 to 100%  
DMX mode: 1-36 channels  
Synchronised shows (internal microphone)  
Simplified control (EASY-2 compatible)  
Master / Slave mode  
Drop-down menu display to assign and  
select different modes  
Independent rotation of each bar over 145°  
DMX IN / OUT by XLR 3-pin plugs POW-  
ER IN / OUT by IEC plugs  
Power consumption: 85W max.  
Power supply: AC 100/230V - 50/60Hz  
Dimensions: 395x234x180mm  
Net weight: 4.9 Kg



### Kadeo460QC

DMX projector with 4 60W 4-in-1 RGBW  
LEDs with zoom and effect

Code : H10652



### CASE for 2x BT-DAZZLE

Flight case for 2x BT-DAZZLE.

Code : B03258



### FLY2CLUB-S2

Flight case for two Storm-8x10 moving  
heads

Code : H10248



4 60W RGBW LED sources  
Rotating lens: Indexable, infinity and  
variable shake  
Beam opening in Par mode from 6° to  
80° by motorised zoom  
RGBW setting and colour macros  
Electronic dimmer variable from 0 to 100%  
DMX mode: 1, 10 or 12 channels  
Synchronised shows (internal microphone)  
Simplified control (EASY-2 compatible)

Master / Slave mode  
Drop-down menu display to assign and  
select different modes  
Independent rotation of each bar over 145°  
DMX IN / OUT by XLR 3-pin plugs POW-  
ER IN by cord and 16A plugs  
Power consumption: 350W max.  
Power supply: AC 100/230V - 50/60Hz  
Dimensions: 342 x 320 x 305 mm  
Net weight: 6.3 Kg

# ANIMATION EFFECTS



## Firestorm-4x10WH

Bar with 4 10W white LED projectors with Pan and Tilt Movements

Code : H10291



## Firestorm-4x10QC

Bar with 4 10W RGBW LED projectors with Pan and Tilt Movements

Code : H10292



## FLY-FIRESTORMx2

Flight case for 2 FIRESTORM

Code : H10339



4 10W White LED sources  
Beam opening 6° per lens  
Strobe, pulse effect and random strobe  
Electronic dimmer variable from 0 to 100%  
DMX mode: 1, 11A, 11B and 15 channels  
Synchronised shows (internal microphone)  
Simplified control (EASY-2 compatible)  
Master / Slave mode  
Drop-down menu display to assign and select different modes  
TILT movement of the bar  
Independent PAN movement over 90° for each projector  
DMX IN / OUT by XLR 3-pin plugs POWER IN / OUT by IEC plugs  
Power consumption: 80W max.  
Power supply: AC 100/230V - 50/60Hz  
Dimensions: 791 x 152 x 232 mm  
Net weight: 10.2 Kg

4 10W RGBW LED sources  
Beam opening 6° per lens  
Strobe, pulse effect and random strobe  
Electronic dimmer variable from 0 to 100%  
DMX mode: 1, 11, 23 and 27 channels  
Synchronised shows (internal microphone)  
Simplified control (EASY-2 compatible)  
Master / Slave mode  
Drop-down menu display to assign and select different modes  
TILT movement of the bar  
Independent PAN movement over 90° for each projector  
DMX IN / OUT by XLR 3-pin plugs POWER IN / OUT by IEC plugs  
Power consumption: 78W max.  
Power supply: AC 100/230V - 50/60Hz  
Dimensions: 791 x 232 x 152 mm  
Net weight: 10.2 Kg



## RADIUS-515

Beam effect with 5 15W 4-in-1 RGBW LEDs

Code : H10667



## Swell-6x10WH

Rotating multibeam bar with 6 white 10 W LEDs

Code : H10260



5 15W RGBW LED sources  
Beam opening 4° per lens  
Automatic or musical programmes  
DMX control: 1,9,12 or 28 channels  
Drop-down menu display to assign and select different modes  
Bar rotation over 240°  
DMX IN / OUT by XLR 3-pin plugs POWER IN / OUT by IEC plugs  
Power consumption: 80W max.  
Power supply: AC 100/230V - 50/60Hz  
Dimensions: 525 x 280 x 250 mm  
Net weight: 5.870 kg

6 10W White LED sources  
Beam opening 6° per lens  
Strobe, pulse effect and random strobe  
Electronic dimmer variable from 0 to 100%  
DMX mode: 1-13 channels  
Synchronised shows (internal microphone)  
Simplified control (EASY-2 compatible)  
Master / Slave mode  
Drop-down menu display to assign and select different modes  
Bar rotation over 240°  
DMX IN / OUT by XLR 3-pin plugs POWER IN / OUT by IEC plugs  
Power consumption: 64.5W max.  
Power supply: AC 100/230V - 50/60Hz  
Dimensions: 843 x 170 x 84 mm  
Net weight: 4.9 Kg

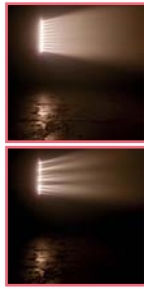

### SunBar103W

Bar with 10 warm white 3W LEDs with pixel control

Code : H10653



### FLY4Sunbar103

Flight case for 4x SUNBAR103W

Code : H10738



### SUPER LED RAINBOW

Powerful multibeam LED effects

Code : B04171



10 3W Warm White LED sources  
17 variable speed or sound-based pixel scrolling programmes  
Strobe, pulse effect and random strobe  
Electronic dimmer variable from 0 to 100%  
DMX mode: 1, 3, 5, 10 or 15 channels  
Synchronised shows (internal microphone)  
Simplified control (EASY-2 compatible)  
Master / Slave mode  
Drop-down menu display to assign and select different modes  
DMX IN / OUT by XLR 3-pin plugs POWER IN / OUT by Powercon plugs  
Power consumption: 36W max.  
Power supply: AC 100/230V - 50/60Hz  
Dimensions: 999 x 170 x 50 mm  
Net weight: 3.4 Kg

6 10W RGBW LED sources  
Beam opening 9° per lens  
Synchronised shows (internal microphone)  
Automatic or musical programmes  
Master / Slave mode  
DMX control: 1, 8 or 28 channels  
Simplified control (CA-8 compatible)  
Drop-down menu display to assign and select different modes  
DMX IN / OUT by XLR 3-pin plugs POWER IN / OUT by IEC plugs  
Power consumption: 80.6W max.  
Power supply: AC 100/230V - 50/60Hz  
Dimensions: 418 x 233 x 122 mm  
Net weight: 4.18 kg



### Beam-4x10QC

Multibeam coloured light bar 4x10W Compact multi-beam effect

Code : H10179



### Beam-4x10WH

Multibeam white light bar 4x10W Compact multibeam effect

Code : H10180



### FLASHBEAM

Double light bar with 8 9W TRI LEDs and 4 white Flash LEDs

Code : H10481



4 10W RGBW LED sources  
Beam opening 6° per lens  
Strobe, pulse effect and random strobe  
Electronic dimmer variable from 0 to 100%  
DMX mode: 1-18 channels  
Synchronised shows (internal microphone)  
Simplified control (EASY-2 compatible)  
Master / Slave mode  
Drop-down menu display to assign and select different modes  
DMX IN / OUT by XLR 3-pin plugs POWER IN / OUT by IEC plugs  
Power consumption: 45W max.  
Power supply: AC 100/230V - 50/60Hz  
Dimensions: 380x165x80mm  
Net weight: 2.7 Kg

4 10W White LED sources  
Beam opening 6° per lens  
Strobe, pulse effect and random strobe  
Electronic dimmer variable from 0 to 100%  
DMX mode: 1-6 channels  
Synchronised shows (internal microphone)  
Simplified control (EASY-2 compatible)  
Master / Slave mode  
Drop-down menu display to assign and select different modes  
DMX IN / OUT by XLR 3-pin plugs POWER IN / OUT by IEC plugs  
Power consumption: 45W max.  
Power supply: AC 100/230V - 50/60Hz  
Dimensions: 380x165x80mm  
Net weight: 2.7 Kg

8 9W RGB LED sources  
Beam opening 3° per lens + 4 White 1W LEDs (stroboscope)  
Pre-programmed shows, Colour control and stroboscopic LEDs  
Electronic dimmer variable from 0 to 100%  
Master / Slave mode  
DMX mode: 1, 4, 14 or 15 channels  
DMX IN / OUT by XLR 3-pin plugs POWER IN / OUT by IEC plugs  
Power consumption: 76W max.  
Power supply: AC 100/230V - 50/60Hz  
Dimensions: 605 x 184 x 268 mm  
Net weight: 3.2 kg





# ANIMATION EFFECTS



## SUPER QUADRA BEAM

Extremely dynamic scanning LED

Code : B04180



4 groups of 9 pcs 1W LEDs  
 (8 x red, 8 x green, 8 blue, 12 x white)  
 Synchronised shows (internal microphone)  
 Automatic or musical programmes  
 Master / Slave mode  
 DMX control: 1 or 3 channels  
 Simplified control (CA-8 compatible)  
 Drop-down menu display to assign and select different modes  
 DMX IN / OUT by XLR 3-pin plugs POWER IN / OUT by IEC plugs  
 Power consumption: 66 W max.  
 Power supply: AC 100/230V - 50/60Hz  
 Dimensions: 830 x 171 x 202 mm  
 Net weight: 5 kg



## SUPER ORION

Extremely dynamic scanning LED effect

Code : B04179



4 groups of 9 pcs 1W LEDs  
 (8 x red, 8 x green, 8 blue, 12 x white)  
 Synchronised shows (internal microphone)  
 Automatic or musical programmes  
 Master / Slave mode  
 DMX control: 1 or 3 channels  
 Simplified control (CA-8 compatible)  
 Drop-down menu display to assign and select different modes  
 DMX IN / OUT by XLR 3-pin plugs POWER IN / OUT by IEC plugs  
 Power consumption: 67 W max.  
 Power supply: AC 100/230V - 50/60Hz  
 Dimensions: 430 x 256 x 172 mm  
 Net weight: 4.1 kg



## ORION

LED effect

Code : B04143



4 groups with a total of 224 LEDs  
 (80 red, 60 green, 48 blue, 36 white)  
 Synchronised shows (internal microphone)  
 Automatic or musical programmes  
 Master / Slave mode  
 DMX control: 1, 4 and 7 channels  
 Simplified control (CA-8 compatible)  
 Drop-down menu display to assign and select different modes  
 DMX IN / OUT by XLR 3-pin plugs POWER IN / OUT by IEC plugs  
 Power consumption: 30 W max.  
 Power supply: AC 100/230V - 50/60Hz  
 Dimensions: 475 x 290 x 160 mm  
 Net weight: 5.3 kg



## ALIEN

LED effect + UV + stroboscope + Laser

Code : B06200



3 projectors with 9 8 W RGB+UV LEDs  
 Effect with 84 0.75 W RGB+UV LEDs  
 Stroboscopic: 12 0.5 W white LEDs  
 Laser: red (100 mW) and green (30 mW)  
 laser motifs  
 IR remote control included  
 Synchronised shows (internal microphone)  
 Automatic or musical programmes  
 Master / Slave mode  
 DMX control: 3, 9, 11 or 28 channels  
 Drop-down menu display to assign and select different modes  
 DMX IN / OUT by XLR 3-pin plugs POWER IN / OUT by IEC plugs  
 Power consumption: 66 W max.  
 Power supply: AC 100/230V - 50/60Hz  
 Dimensions: 830 x 171 x 202 mm  
 Net weight: 5 kg

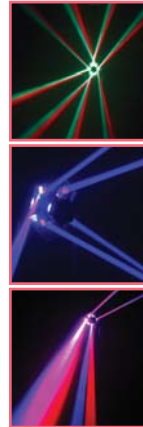

## BEAM TWISTER

Compact and innovative LED projector

Code : B04183



32W RGBW LED source  
 Synchronised shows (internal microphone)  
 Automatic or musical programmes  
 Master / Slave mode  
 DMX control: 1 or 4 channels  
 Simplified control (CA-8 compatible)  
 Drop-down menu display to assign and select different modes  
 DMX IN / OUT by XLR 3-pin plugs POWER IN / OUT by IEC plugs  
 Power consumption: 50W max.  
 Power supply: AC 100/230V - 50/60Hz  
 Dimensions: 350 x 352 x 203 mm  
 Net weight: 3.3 kg



## GOBOBEAM

Animation effect with 8 3W LEDs with projection of moving gobos

Code : H10662



8 3W RGB LED sources  
 Synchronised shows (internal microphone)  
 Automatic or musical programmes  
 Master / Slave mode  
 DMX control: 1, 8 or 12 channels  
 Simplified control (EASY-2 compatible)  
 Drop-down menu display to assign and select different modes  
 DMX IN / OUT by XLR 3-pin plugs POWER IN / OUT by IEC plugs  
 Power consumption: 40W max.  
 Power supply: AC 100/230V - 50/60Hz  
 Dimensions: 290 x 160 x 220 mm  
 Net weight: 3 kg





### LED-BLASTER

Animation effect Multibeam rotation  
2 RGBW 10W LEDs

Code : H9915



### DELirium

Animation effect Multibeam 320 RGBW  
LEDs

Code : H9893



### INVADER

Multieffect: 23W LED eff. + 200mW  
red+green laser

Code : B04176



2 10W RGBW LED sources  
Synchronised shows (internal microphone)  
Automatic or musical programmes  
Master / Slave mode  
DMX control: 1 or 3 channels  
Simplified control (EASY-2 compatible)  
Drop-down menu display to assign and select different modes  
DMX IN / OUT by XLR 3-pin plugs POWER IN / OUT by IEC plugs  
Power consumption: 34W max.  
Power supply: AC 100/230V - 50/60Hz  
Dimensions: 296 x 271 x 140 mm  
Net weight: 3.8 kg

320 LED sources (80 Red, 80 green, 80 blue, 80 white)  
Synchronised shows (internal microphone)  
Automatic or musical programmes  
Master / Slave mode  
DMX control: 4 channels  
Drop-down menu display to assign and select different modes  
DMX IN / OUT by XLR 3-pin plugs POWER IN / OUT by IEC plugs  
Power consumption: 40W max.  
Power supply: AC 100/230V - 50/60Hz  
Dimensions: 309 x 309 x 227 mm  
Net weight: 3.8 Kg

Effect with 5 3 W RGBWA LEDs  
Stroboscopic: 8 1 W white LEDs  
Laser: red (150 mW) and green (50 mW) laser motifs  
Synchronised shows (internal microphone)  
Automatic or musical programmes  
Master / Slave mode  
DMX control: 1 or 9 channels  
Drop-down menu display to assign and select different modes  
DMX IN / OUT by XLR 3-pin plugs POWER IN / OUT by IEC plugs  
Power consumption: 66 W max.  
Power supply: AC 100/230V - 50/60Hz  
Dimensions: 240 x 220 x 110 mm  
Net weight: 3.75 kg



### LED-GUN

Multibeam animation effect with TRI  
10W LED

Code : H9541



### LED-BEAMER

Derby with 2 3-colour 9W LEDs

Code : H10023



### PARTY DERBY

Compact projector with 2 different led effects

Code : B04186



10W RGBW LED source  
Synchronised shows (internal microphone)  
Automatic or musical programmes  
Master / Slave mode  
DMX control: 3 channels  
Simplified control (EASY-2 compatible)  
Drop-down menu display to assign and select different modes  
DMX IN / OUT by XLR 3-pin plugs POWER IN / OUT by IEC plugs  
Power consumption: 12.5 W max.  
Power supply: AC 100/230V - 50/60Hz  
Dimensions: 271 x 176 x 213 mm  
Net weight: 3.0 kg

2 9W RGB LED sources  
Modes of operation:  
- Independent  
- Musical (internal microphone)  
Power consumption: 20W  
Power supply: AC 100/230V - 50/60Hz  
Dimensions: 310 x 205 x 310 mm  
Net weight: 3.4 kg

Derby LED effect  
Stroboscopic: 16 white LEDs  
IR remote control included  
Synchronised shows (internal microphone)  
Automatic or musical programmes  
Master / Slave mode  
DMX control: 1 or 5 channels  
Drop-down menu display to assign and select different modes  
DMX IN / OUT by XLR 3-pin plugs POWER IN / OUT by IEC plugs  
Power consumption: 28 W max.  
Power supply: AC 100/230V - 50/60Hz  
Dimensions: 190 x 258 x 182 mm  
Net weight: 1.72 kg

# ANIMATION EFFECTS

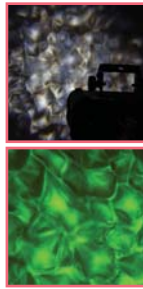

## LED AQUA

25W LED water simulator

Code : B04545



25W White LED source  
6 progressively changing colours  
The colour change can be blocked on 1 colour  
Adjustable focus  
Power consumption: 43.3W max.  
Power supply: AC 100/230V - 50/60Hz  
Dimensions: 255 x 245 x 196 mm  
Net weight: 3.4 kg



## LED VIRTUAL FLAME

Flame simulator 36cm diameter

Code : B04544



Equipped with 5 1W LED light emitting diodes  
The nearly silent fan allows a flame to be projected to a height of about 35 cm  
Place it on a flat surface or hang it with the set of fine mesh chains provided.  
Diameter of the fire cup: 36 cm  
Power consumption: 16.5W max.  
Power supply: AC 100/230V - 50/60Hz  
Net weight: 3.55 kg



## BEAMSPOT-4BAR NW

T-BAR with 4 BEAMSPOT NW 4500K

Code : B05508



4 white 15W 4500K LED sources  
4° opening [10° and 45° filters included]  
Electronic dimmer from 0 to 100%  
2 Mode dimmer: Slow, Fast  
4 Dimmer curves [LINEAR, SQUARE, INV.SQUARE, S-CURVE]  
DMX mode: 1, 2, 4 or 5 channels  
Wireless DMX: WTR-DMX dongle (optional)  
Drop-down menu display  
DMX IN / OUT by XLR 3/5-pin plugs  
POWER IN / OUT by PowerCON plugs  
Spigot support 28mm  
Power supply: AC 100/230V - 50/60Hz  
Dimensions: 552 x 85 x 315 mm  
Net weight: 6.74 Kg



## BEAMSPOT-4BAR WW

T-BAR with 4 BEAMSPOT WW 3200K

Code : B05507



4 15W Warm white 3200K LED sources  
4° opening per lens [10° and 45° filters included]  
Electronic dimmer variable from 0 to 100%  
2 Mode dimmer: Slow (halogen), Fast (LED)  
4 Dimmer curves [LINEAR, SQUARE, INV.SQUARE, S-CURVE]  
DMX mode: 1, 2, 4 or 5 channels  
Wireless DMX: WTR-DMX dongle (optional)  
Drop-down menu display to assign and select different modes  
DMX IN / OUT by XLR 3/5-pin plugs  
POWER IN / OUT by PowerCON plugs  
Spigot support 28mm  
Power consumption: 71W max.  
Power supply: AC 100/230V - 50/60Hz  
Dimensions: 552 x 85 x 315 mm  
Net weight: 6.74 Kg



## PARTY BAR

The PARTY BAR is a fabulous set of 4-in-1 lights for mobile DJs!

Code : B04184



2 Derby effects equipped with a 3 W RGB LED  
2 projectors with 3 RGB 9 W LEDs  
4 cool white LEDs to create stroboscopic effects  
The bi-colour red/green laser  
IR remote control included  
Synchronised shows (internal microphone)  
Automatic or musical programmes  
Master / Slave mode  
DMX control: 3, 5, 6, 9 or 27 channels  
Wireless DMX: WTR-DMX dongle (optional)  
Drop-down menu display to assign and select different modes  
DMX IN / OUT by XLR 3-pin plugs  
POWER IN / OUT by IEC plugs  
Power consumption: 48 W max.  
Power supply: AC 100/230V - 50/60Hz  
Dimensions: 1185 x 386 x 110 mm  
Net weight: 8.35 kg



## PARTY BEAMS

This extremely compact bar is equipped with two different light effects to create superb light effects

Code : B04185



8 9W RGB LED sources  
Beam opening 7° per lens + 4 White 1W LEDs (stroboscope)  
Pre-programmed shows, Colour control and stroboscopic LEDs  
Electronic dimmer variable from 0 to 100%  
Master / Slave mode  
DMX mode: 3, 9 or 14 channels  
DMX IN / OUT by XLR 3-pin plugs  
POWER IN / OUT by IEC plugs  
Power consumption: 76W max.  
Power supply: AC 100/230V - 50/60Hz  
Dimensions: 605 x 184 x 268 mm  
Net weight: 3.2 kg





### SUPER BOOGIE

Double Led Flower DMX

Code : B04178



### SUPER ATLAS

Flower LED 9 x 1Watt

Code : B04177



### LED KAOS

Flower effect with 3 Watt LED

Code : B04175



Equipped with 2 sets of 9 1 Watt LEDs (4 x red, 4 x green, 4 blue, 6 x white)  
Synchronised shows (internal microphone)  
Automatic or musical programmes  
Master / Slave mode  
DMX control: 1 or 3 channels  
Simplified control (CA-8 compatible)  
Drop-down menu display to assign and select different modes  
DMX IN / OUT by XLR 3-pin plugs POWER IN / OUT by IEC plugs  
Power consumption: 35 W max.  
Power supply: AC 100/230V - 50/60Hz  
Dimensions: 246 x 230 x 164 mm  
Net weight: 2.6 kg

Equipped with 9 1 Watt LEDs (2 x red, 2 x green, 2 blue, 3 x white)  
Automatic programmes (internal microphone)  
Consumption: 20 W max.  
Power supply: AC 100/230V - 50/60Hz  
Dimensions: 141 x 224 x 203 mm  
Net weight: 1.4 kg

Flower effect equipped with one 3 Watt LED  
Plug & play  
3 operating modes: Static, automatic rotation, activated to the rhythm of the music.  
Double reflector  
Internal microphone  
External power supply transformer  
Consumption: 10 W max.  
Power supply: AC 100/230V - 50/60Hz  
Dimensions: 286 x 165 x 134 mm  
Net weight: 0.74 kg



### LED MOON

Rotating Flower Effect with extremely compact LED

Code : B04174



### LED DIAMOND

A DMX effect with very compact LED

Code : B04170



### LED DIAMOND II

A LED projector controlled by very attractive and compact DMX

Code : B04188



Rotating Flower effect equipped with one 3 Watt LED  
Plug & play  
3 operating modes: Static, automatic rotation, activated to the rhythm of the music.  
Double reflector  
Internal microphone  
External power supply transformer  
Consumption: 10 W max.  
Power supply: AC 100/230V - 50/60Hz  
Dimensions: 195 x 165 x 134 mm  
Net weight: 0.64 kg

6 3W LED sources (2 x red, 2 x green, 2 x blue)  
The 80 lenses project a full set of coloured rays covering a space of 360 degrees  
Synchronised shows (internal microphone)  
Automatic or musical programmes  
Master / Slave mode  
DMX control: 1 or 6 channels  
Drop-down menu display to assign and select different modes  
DMX IN / OUT with 3-pin plugs  
Power consumption: 35 W max.  
Power supply: AC 100/230V - 50/60Hz  
Dimensions: dia 183 x 157 mm  
Net weight: 1.07 kg

6 3W LED sources (1 red + 1 green + 1 blue + 1 white + 1 orange + 1 violet)  
The various lenses project many beams of clean colour over more than 360 degrees  
Synchronised shows (internal microphone)  
Automatic or musical programmes  
Master / Slave mode  
DMX control: 1 or 6 channels  
Drop-down menu display to assign and select different modes  
DMX IN / OUT with 3-pin plugs  
Power consumption: 24 W max.  
Power supply: AC 100/230V - 50/60Hz  
Dimensions: dia 190 x 175 mm  
Net weight: 0.42 kg



# ANIMATION EFFECTS



## NightBall

Half-sphere with 3 1W RGB LEDs With infrared remote control

Code : H10711



3 RGB 1W LEDs  
Automatic mode  
Sound mode  
Weight: 0.195 Kg  
Power consumption: 5W  
Dimensions: 125 x 105 x 120 mm  
AC 240V - 50Hz / 5 V DC adaptor supplied



## NightMotion

Mushroom type animation effect with 3 3W RGB LEDs With infrared remote control

Code : H10645



3 RGB 3W LEDs  
Automatic mode  
Sound mode  
Weight: 0.950 Kg  
Power consumption: 10W  
Dimensions: 180 x 160 x 190 mm  
AC 240V - 50Hz / 12 V DC adaptor supplied



## NightDerby

Derby type animation effect with 3 3W RGB LEDs With infrared remote control

Code : H10647



3 RGB 3W LEDs  
Automatic mode  
Sound mode  
Weight: 0.950 Kg  
Power consumption: 10W  
Dimensions: 180 x 160 x 200 mm  
AC 240V - 50Hz / 12 V DC adaptor supplied



## NightFlower

Flower type animation effect with 9W RGB LED With infrared remote control

Code : H10646



1 3-in-1 RGB 9W LED  
Automatic mode  
Sound mode  
Weight: 0.950 Kg  
Power consumption: 10W  
Dimensions: 180 x 160 x 190 mm  
AC 240V - 50Hz / 12 V DC adaptor supplied



## NightColor

Wash projector with 3 1W RGB LEDs With infrared remote control

Code : H10648



3x1W 1R 1G 1B LED  
Automatic mode  
Sound mode  
Weight: 0.55 Kg  
Power consumption: 5W  
Dimensions: 190 x 60 x 110 mm  
AC 240V - 50Hz / 12 V DC adaptor supplied



## LED MARVEL

LED Projector

Code : B04543



6 LED panels  
216 LEDs (72 red, 72 green, 72 blue)  
Static or sound-activated programmes (internal microphone)  
IR remote control included  
Control by DMX possible: 21 channels  
Weight: 0.6 Kg  
Power consumption: 12W  
Dimensions: 68 x 39 x 434 mm  
AC 240V - 50Hz / 12 V DC adaptor supplied



### NightFluo

Bar with 5 UV 1W LEDs and 4 Flash LEDs  
With infrared remote control

Code : H10649



5 UV LEDs  
4 Flash LEDs  
Automatic mode  
Sound mode  
Weight: 0.245 Kg  
Power consumption: 12W  
Dimensions: 530 x 40 x 60 mm  
AC 240V - 50Hz / 12 V DC adaptor supplied



### LED POLICE LIGHT BLUE

Blue LED rotating beacon

Code : B04540



Rotating beacon with 108 extremely brilliant LEDs  
Adjustable rotation speed  
Weight: 0.86 Kg  
Dimensions: dia 143 x 182 mm  
AC 240V - 50Hz / 12 V DC adaptor supplied



### LED POLICE LIGHT RED

Red LED rotating beacon

Code : B04541



Rotating beacon with 108 extremely brilliant LEDs  
Adjustable rotation speed  
Weight: 0.86 Kg  
Dimensions: dia 143 x 182 mm  
AC 240V - 50Hz / 12 V DC adaptor supplied



### LED SIXLIGHT

6-channel chaser with integrated microphone

Code : B04538



6 channel chaser  
Equipped with 282 LEDs (47 red, 47 green, 94 blue, 47 orange and 47 yellow)  
Modular: possibility of changing the shape of the device  
Integrated microphone  
Adjustable speed and audio sensitivity  
Weight: 2.1 Kg  
Dimensions: 365 x 347 x 182 mm  
AC 240V - 50Hz / 14 V DC adaptor supplied





# LASERS



## BT-LASER1500 RGB

1.5 W - R:500 mW - G:200 mW - B:800 mW

Code : B04235



## SPECTRA-3D Laser

480 mW - R:100 mW - G:80 mW - B:300 mW

Code : B04230



## MULTIBEAM LASER

850 mW - 2xR: 150 mW - G: 50 mW - B: 500 mW

Code : B04236



Superb 1.5Watt Class IV laser  
Incorporates 3 powerful coloured lasers (RVB):  
Red laser 500 mW (638 nm)  
Green laser 200 mW (532 nm)  
Blue laser 800 mW (450 nm)  
20Kpps scanners for clean, flawless RGB images!  
100% ILDA compatible for maximum flexibility in use!  
SD card reader to project your own motifs and logos.  
6 user modes  
CONTROLLED BY THE MUSIC  
MASTER/SLAVE  
AUTOMATIC  
DMX mode: 1 or 13 channels  
ILDA mode  
SD CARD mode  
Power consumption: 45W max.  
Power supply: AC 100/230V - 50/60Hz  
Dimensions: 300 x 240 x 160 mm  
Net weight: 7.8 kg  
Meets EN/IEC 60825-1 Ed2, 2007-03 safety standards with respect to lasers

RGB Class III 480mW laser  
Incorporates 3 powerful coloured lasers (RGB):  
Red laser 100 mW (638 nm)  
Green laser 80 mW (532 nm)  
Blue laser 300 mW (450 nm)  
25Kpps scanners combined with 4 effect wheels, Motifs and 3D effect shows, 80 motifs and RGB beams, burst effects... ILDA compatible for maximum use flexibility!  
User modes:  
MASTER/SLAVE  
STANDALONE: automatic and sound  
DMX mode: 1, 2 or 19 channels  
ILDA mode  
Power consumption: 40W max.  
Power supply: AC 100/230V - 50/60Hz  
Dimensions: 290 x 240 x 110 mm  
Net weight: 4.16 kg  
Meets EN/IEC 60825-1 Ed2, 2007-03 safety standards with respect to lasers

RGRB White Class 3B 850 mW laser equipped with 4 powerful temperature controlled lasers:  
2 150 mW red lasers (650 nm)  
1 50 mW green laser (532 nm)  
1 500 mW blue laser (450 nm)  
4 user modes:  
Musical mode: 100% plug&play  
MASTER/SLAVE mode  
AUTOMATIC mode  
DMX mode: 2 or 10 channels  
Infrared remote control included  
LED display to facilitate navigation in the configuration menu  
Power consumption: 65W max.  
Power supply: AC 100/230V - 50/60Hz  
Dimensions: 537 x 268 x 170 mm  
Net weight: 5 kg  
Meets EN/IEC 60825-1 Ed2, 2007-03 safety standards with respect to lasers



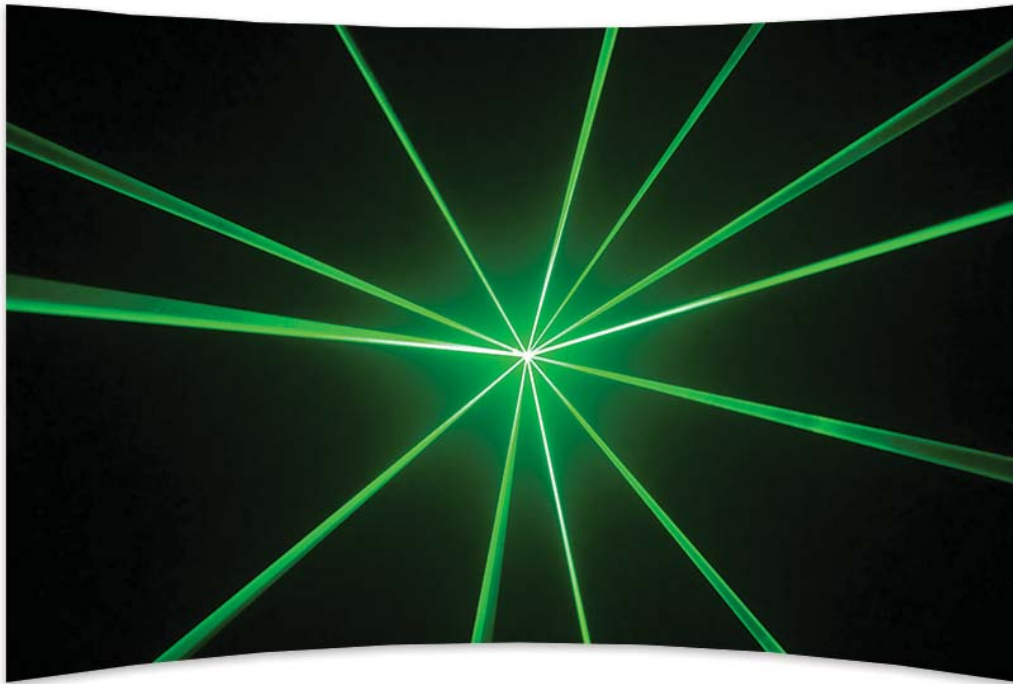

### SPACE-4 Laser

G: 40mW

Code : B04232



Green 40mW Class 3B compact laser  
 Several modes are available:  
 DMX mode: 1 or 8 channels  
 Standalone mode: sound activated (via internal microphone) or automatic mode  
 Infrared remote control included  
 Master/Slave mode  
 3-digit LED display for simple navigation of the menus  
 Power consumption: 12W max.  
 Power supply: AC 100/230V - 50/60Hz  
 Dimensions: 145 x 160 x 80 mm  
 Net weight: 1.48 kg  
 Meets EN/IEC 60825-1 Ed2, 2007-03 safety standards with respect to lasers

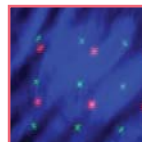

### LOUNGE LASER DMX

190 mW R: 150 mW -G: 40 mW

Code : B04221



190mW laser with one green 40mW laser and one 150mW red laser + blue LED projector with waterwave style!  
 Several modes are available:  
 DMX mode: 1 or 7 channels  
 Standalone mode: sound activated (via internal microphone) or automatic mode  
 Master/Slave mode  
 3-digit LED display for simple navigation of the menus  
 Power consumption: 15W max.  
 Power supply: AC 100/230V - 50/60Hz  
 Dimensions: 233 x 165 x 200 mm  
 Net weight: 1.9 kg  
 Meets EN/IEC 60825-1 Ed2, 2007-03 safety standards with respect to lasers

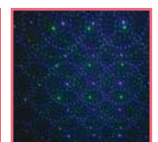

### μ-PHOTON Laser

120 mW - G: 40 mW - B: 80 mW

Code : B04229



Laser using a green 40mW 532nm laser and a blue 80mW 450nm laser  
 Plug-and-Play: no controller necessary!  
 Infrared remote control included  
 Standalone mode with integrated microphone or automatic shows mode.  
 Stroboscopic effect available  
 Adjustable support and AC adaptor included.  
 Power consumption: 5.7 W max.  
 Power supply: AC 100/230V - 50/60Hz  
 Dimensions: 117 x 92 x 46 mm  
 Net weight: 0.64 kg  
 Complies with EN/IEC 60825-1 Ed2, 2007-03 standards concerning Laser Safety

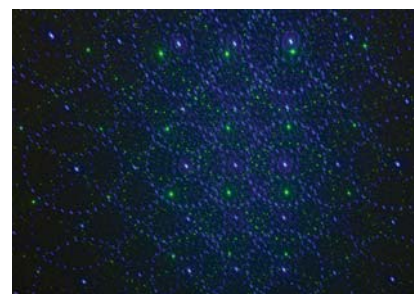

# LASERS



## RADIANT LASER

240 mW - G: 40 mW - B: 200 mW

Code : B04222



## SMOOTH SCAN-BLUE Laser

G: 400 mW

Code : B04227



## SMOOTH SCAN-3 Laser

140 mW - G: 100 mW - V: 40 mW

Code : B04226



## LASER INTERLOCK SWITCH

Emergency stop mushroom button for Laser

Code : B04210



Class 3B Laser with one green 40mW 532nm laser and one blue 200mW 450nm laser.  
Several modes are available:  
DMX mode: 1 or 10 channels  
Standalone mode: sound activated (via internal microphone) or automatic mode  
Master/Slave mode  
Simplified control (CA-8 compatible)  
Compatible with RF-DMX Converter:  
3-character LED screen for easy navigation through the menus.  
Power consumption: 30W max.  
Power supply: AC 100/230V - 50/60Hz  
Dimensions: 250 x 240 x 190 mm  
Net weight: 2.92 kg  
Meets EN/IEC 60825-1 Ed2, 2007-03 safety standards with respect to lasers

Class 3B Laser based on one blue 400mW 450nm laser.  
Fluid movements, 80 motifs, numbers, designs, words, etc....  
Several modes are available:  
DMX mode: 1 or 17 channels  
Standalone mode: sound activated (via internal microphone) or automatic mode  
Infrared remote control included  
Master/Slave mode  
3-digit LED display for simple navigation of the menus  
Power consumption: 13W max.  
Power supply: AC 100/230V - 50/60Hz  
Dimensions: 190 x 170 x 80 mm  
Net weight: 1.61 kg  
Meets EN/IEC 60825-1 Ed2, 2007-03 safety standards with respect to lasers

Class 3B Laser based on one green 40mW 532nm laser and one red 100mW 650nm laser.  
Fluid movements, 80 motifs, numbers, designs, words, etc....  
Several modes are available:  
DMX mode: 1 or 17 channels  
Standalone mode: sound activated (via internal microphone) or automatic mode  
Infrared remote control included  
Master/Slave mode  
3-digit LED display for simple navigation of the menus  
Power consumption: 13W max.  
Power supply: AC 100/230V - 50/60Hz  
Dimensions: 190 x 170 x 80 mm  
Net weight: 1.61 kg  
Meets EN/IEC 60825-1 Ed2, 2007-03 safety standards with respect to lasers

This emergency switch is additional safety for your laser projector.







**μ-QUANTUM Laser**  
180 mW - R: 100 mW - B: 80 mW

Code : B04228



Laser using one red 100mW 650nm laser and one blue 80mW 450nm laser  
 Plug-and-Play: no controller necessary!  
 Infrared remote control included  
 Standalone mode with integrated microphone or automatic shows mode.  
 Stroboscopic effect available  
 Adjustable support and AC adaptor included.  
 Power consumption: 5.7 W max.  
 Power supply: AC 100/230V - 50/60Hz  
 Dimensions: 117 x 92 x 46 mm  
 Net weight: 0.64 kg  
 Complies with EN/IEC 60825-1 Ed2, 2007-03 standards concerning Laser Safety

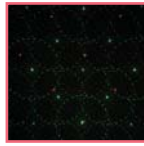

**μ-QUASAR Laser**  
140 mW - G: 40 mW - R: 100 mW

Code : B04225



Laser using one red 100mW 650nm laser and one green 40mW 532nm laser  
 Plug-and-Play: no controller necessary!  
 Infrared remote control included  
 Standalone mode with integrated microphone or automatic shows mode.  
 Stroboscopic effect available  
 Adjustable support and AC adaptor included.  
 Power consumption: 5.7 W max.  
 Power supply: AC 100/230V - 50/60Hz  
 Dimensions: 117 x 92 x 46 mm  
 Net weight: 0.64 kg  
 Complies with EN/IEC 60825-1 Ed2, 2007-03 standards concerning Laser Safety



**μ-STAR Laser**  
140 mW - G: 40 mW - R: 100 mW

Code : B04224



Laser using one red 100mW 650nm laser and one green 40mW 532nm laser  
 Plug-and-Play: no controller necessary!  
 Infrared remote control included  
 Standalone mode with integrated microphone or automatic shows mode.  
 Stroboscopic effect available  
 Adjustable support and AC adaptor included.  
 Power consumption: 5.7 W max.  
 Power supply: AC 100/230V - 50/60Hz  
 Dimensions: 117 x 92 x 46 mm  
 Net weight: 0.64 kg  
 Complies with EN/IEC 60825-1 Ed2, 2007-03 standards concerning Laser Safety

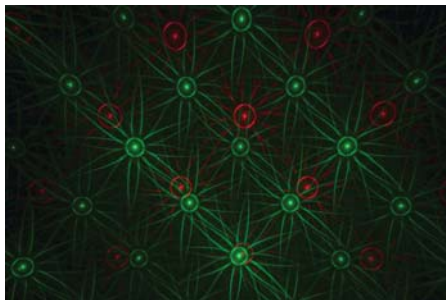
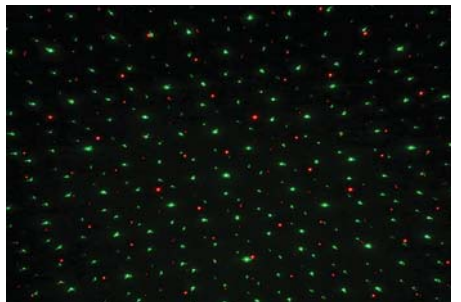

# STROBES



## BT-GIGAFLASH RGB

Colour LED strobe with 3 separately controllable segments and 1260 RGB strobe LEDs

Code : B04716



## BT-GIGAFLASH

Strobe LED with 9 separately controllable segments and a light output of +/- 100 000 lm.

Code : B04714



## BT-MAGICFLASH RGB

Colour LED strobe with 3 separately controllable segments and 324 RGB strobe LEDs

Code : B04717



1260 RGB LEDs source  
3 independent sections frequency from 0 to 30 Hz and Blinder mode  
Flicker free  
7 different DMX modes with 1 to 13 channels  
LCD display with drop-down menu  
Reflector shutters for more rendering  
DMX 3 and 5 XLR  
Powercon In and Out  
Forced and regulated ventilation  
Power supply: 240V/50Hz 800 W max  
Dimensions: 471 x 195 x 274 mm  
Weight: 8.5 kg

1260 4500°K LEDs source  
9 independent sections frequency from 0 to 30 Hz and Blinder mode  
Flicker free  
7 different DMX modes with 1 to 13 channels  
LCD display with drop-down menu  
Reflector shutters for more rendering  
DMX 3 and 5 XLR  
Powercon In and Out  
Forced and regulated ventilation  
Power supply: 240V/50Hz 900 W max  
Dimensions: 471 x 195 x 274 mm  
Weight: 8.5 kg

324 RGB LEDs source  
3 independent sections frequency from 0 to 30 Hz and Blinder mode  
Flicker free  
7 different DMX modes with 1 to 13 channels  
LCD display with drop-down menu  
DMX XLR 3  
Powercon In and Out  
Forced and regulated ventilation  
Power supply: 240V/50Hz 140 W max  
Dimensions: 336 x 126 x 212 mm  
Weight: 4.0 kg



## BT-MAGICFLASH

Powerful LED strobe with 9 separately controllable segments and a light output of +/- 35,000 lm.

Code : B04715



## BT-STROBE3000

Powerful professional strobe with outstanding brightness.

Code : B04711



## BT-STROBE 1500

A powerful 1,500 W professional strobe, 2 DMX channels with intense light output.

Code : B04713



324 4500°K LEDs source  
9 independent sections frequency from 0 to 30 Hz and Blinder mode  
Flicker free  
7 different DMX modes with 1 to 13 channels  
LCD display with drop-down menu  
DMX XLR 3  
Powercon In and Out  
Forced and regulated ventilation  
Power supply: 240V/50Hz 250 W max  
Dimensions: 336 x 126 x 212 mm  
Weight: 4.0 kg

PX-3000 Xenon lamp source  
Variable frequency and effects  
4 different DMX modes with 1 to 4 channels  
Drop-down menu LED display  
DMX 3 and 5 XLR  
Power supply: 240V/50Hz 250 W max  
Dimensions: 486 x 154 x 255 mm  
Weight: 6.8 kg

1500W Xenon lamp source  
Variable frequency and effects  
Adjustment of speed and dimmer by potentiometer  
2 DMX channels (speed and dimmer)  
DMX XLR 3  
Input Jack for CA-8 controller  
Power supply: 240V/50Hz  
Dimensions: 458 x 147 x 116 mm  
Weight: 3.58 kg





### STB-520

1500 W active sound strobe and DMX

Code : H7122



Xenon XOP15 1500 W lamp source  
Variable frequency and audio mode  
Adjustment of speed and dimmer by dip switches  
2 DMX channels (speed and dimmer)  
DMX XLR 3  
Power supply: 240V/50Hz  
Dimensions: 455 x 205 x 137 mm  
Weight: 5.2 kg



### LED STROBE

Strobe, 68x 5mm white led, 4prog/sound.

Code : B04705



68 LEDs of 5mm source  
Variable frequency, sound mode and effects  
Adjustment of modes, speed and dimmer by potentiometer  
Power supply: 240V/50Hz  
Dimensions: 132 x 188 x 164 mm  
Weight: 0.5 kg

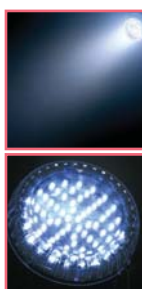

### LED MINI FLASH

Strobe, 20x 5mm white led, 1-20 FL/sec

Code : B04706



20 LEDs of 5mm source  
Frequency variable from 0 to 20 Hz  
Speed adjustment by potentiometer  
Power supply: 240V/50Hz  
Dimensions: 110 x 90 x 70 mm  
Weight: 0.22 kg



# BLACK LIGHT



## UV-GUN 100W LED

UV projector with 100W "COB" LED

Code : B03807



UV 100W COB LED on individual reflector  
 Beam angle: 100°  
 DMX IN/OUT by XLR 3  
 4-digit display with drop-down menu IR remote control for:  
 Dimmer, Strobe, audio mode, Master/Slave  
 Regulated fan cooling  
 Power supply: AC 100/240V - 50/60Hz  
 Dimensions: 263 x 309 x 300 mm  
 Net weight: 4.1 Kg



## UV-BAR LED

Reliable ultraviolet LED light bar with many advantages over a traditional UV lamp

Code : B03806



12 UV 3W LEDs on individual reflector  
 Beam angle: 100°  
 DMX IN/OUT by XLR 3  
 4-digit display with drop-down menu IN/OUT power supply via IEC plug  
 IR remote control for:  
 Dimmer, Strobe, audio mode, Master/Slave  
 Convection cooling without fan  
 Power supply: AC 100/240V - 50/60Hz  
 Dimensions: 1050 x 93 x 88 mm  
 Net weight: 2.7 Kg



## LED-UV8

Black light projector with 8pcs 1W UV LEDs

Code : H9956



8 UV 1W LEDs on metal reflector  
 Beam angle: 65°  
 ON/OFF switch  
 Convection cooling without fan  
 Power supply: AC 100/240V - 50/60Hz  
 Dimensions: 160 x 80 x 60 mm  
 Net weight: 0.950 Kg



## LED-UV12

Floodlight with 12 3W UV LEDs

Code : H10288



12 UV 3W LEDs on individual reflector  
 Beam angle: 65°  
 4-digit display with drop-down menu  
 DMX IN/OUT by XLR 3  
 IN/OUT power supply by IEC plug  
 Convection cooling without fan  
 Power supply: AC 100/240V - 50/60Hz  
 Dimensions: 295 x 228 x 95 mm  
 Net weight: 2.2 Kg



# MIRROR BALLS



**MIRROR BALL 20/50 cm**  
Mirror ball 20"/50 cm

Code : B02026



**MIRROR BALL 16/40 cm**  
Mirror ball 16"/40 cm

Code : B02024

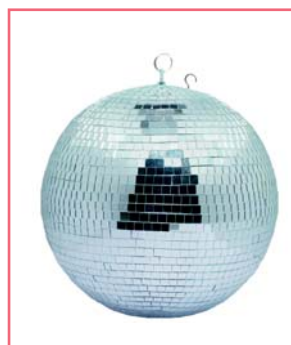

**MIRROR BALL 12/30 cm**  
Mirror ball 12"/30 cm

Code : B02023

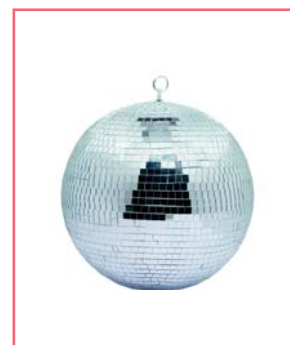

**MIRROR BALL 8/20 cm**  
Mirror ball 8"/20 cm

Code : B02022



**MIRROR BALL 4/10 cm**  
Mirror ball 4"/10 cm

Code : B02027



**MB ROTATOR Heavy duty**  
Motor for mirror balls up to a weight of 10 kg

Code : B04123



**MB ROTATOR STANDARD**  
Mirror ball motor: 1.5 rpm.

Code : B02021



**MB ROTATOR BATTERY**  
Motor for mirror balls with a maximum diameter of 20 cm

Code : B02020





# CONTROLLERS

Chromateq® offers innovative DMX lighting control solutions (lighting and multimedia) for professional architectural lighting and the entertainment world.

It is a solution adapted to all types of projects and for all sectors of activity: audio system, discos, theatres, concerts, live performances, LED installations, architectural lighting inside and outside, monuments, exhibitions and other services.

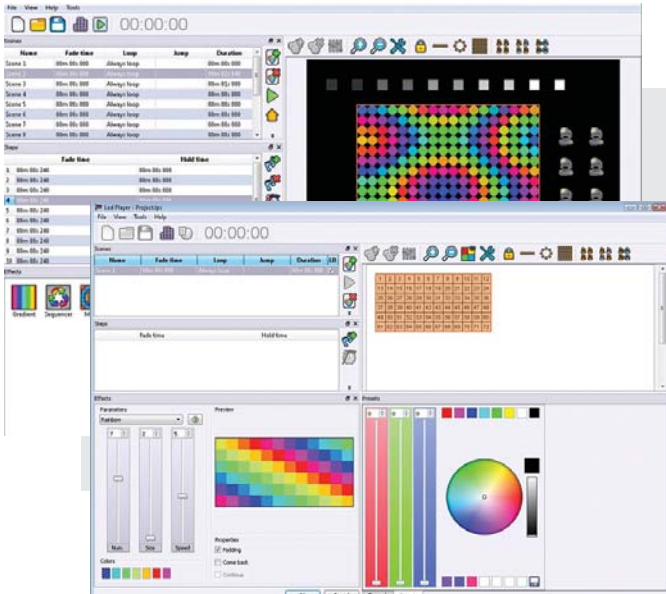

## LED PLAYER

Led Player is ideal for all DMX (architectural and entertainment) applications and fixed installations. It can control all standard DMX devices and can record a show in the interfaces. The LED Player is the easiest and most economical solution for DMX lighting control.



**LD-512WALL+**  
DMX wall controller.  
For CHROMATEQ software.

Code : B05016



**LD-512BOX**  
512-channel DMX interface with remote control IR  
For CHROMATEQ software

Code : B05005



**LD-1024BOX**  
DMX interface with 1024 DMX channels.  
For CHROMATEQ software

Code : B05006



**LD-512EASY+**  
512-channel DMX interface with 8 buttons.  
For CHROMATEQ software.

Code : B05012



Wall interface compatible with "Chromateq Led Player" software (supplied)  
512 DMX channels  
Internal memory for max. 255 scenes  
Activation by external contacts  
Access to 10 scenes by buttons  
Direct access to the interface:  
Trigger, Speed, Dimmer  
Calendar function  
Merger mode  
Operating system: Windows & MAC OS X & Linux  
DMX outputs on terminal block  
Power supply: By mini USB 5V or DC 9-36 V  
Art-Net Universe available: 1

Compact DMX interface  
Wall interface compatible with "Chromateq Led Player" software (supplied)  
IR remote control  
512 DMX channels  
256 channels in standalone  
Internal memory for max. 255 scenes  
IR remote control included for:  
Choice of scenes, speed, dimmer, BO  
Operating system: Windows & MAC OS X & Linux  
DMX outputs on XLR connectors  
Power supply: By mini USB 5V (cable supplied)  
Art-Net Universe available: 1

Standalone compact DMX interface  
Compatible with "Chromateq Led Player" and "Chromateq Pro DMX" software. (supplied)  
1024 DMX channels [2x512]  
132 channels in standalone  
Internal memory for max. 255 scenes  
IR receiver for optional remote control  
Operating system: Windows & MAC OS X & Linux  
DMX Inputs and Outputs on XLR and terminal block connectors.  
Power supply: By mini USB 5V (cable supplied)  
Art-Net Universe available: 2

Compact DMX interface  
"Chromateq Led Player" and "Chromateq Pro DMX". (supplied)  
512 DMX channels  
Internal memory for max. 255 scenes  
SD card slot for more memory  
Activation by external contacts  
Access to 80 programs by 8 buttons  
Direct access to the interface:  
Trigger, Page, Colour, Speed, Dimmer  
Calendar function  
Splitter mode 2x512  
Operating system: Windows & MAC OS X & Linux  
DMX outputs on XLR connectors  
Power supply: By mini USB 5V or DC 9-36 V  
Art-Net Universe available: 1

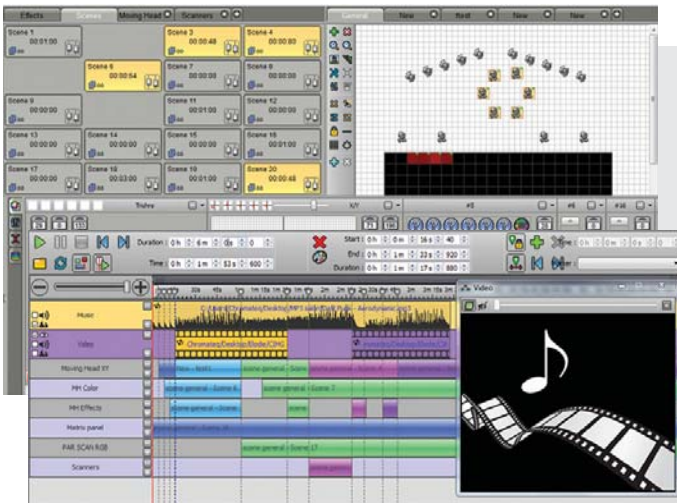

## PRO DMX

Professional software for experienced users and the production of quality shows. Thanks to the Timeline, it is the indispensable controller for Live performances and synchronizations in Audio, Video and lighting. Pro DMX will animate and embellish all your artistic creations easily.



## WI-LIGHT

The application can be used as a WIFI remote control with the LED Player software and LD-512WIFI interface. It can control all Live Board mode and standalone mode controls through a local WIFI connection. For smartphones and tablets.



### LD-512WIFI

DMX interface with 512 DMX channels. For CHROMATEQ software and Wi-Light app

Code : B05009



Compact DMX interface compatible with Wi-Light application.  
Compatible with "Chromateq Led Player" and "Chromateq Pro DMX" software. (supplied)  
512 DMX channels  
Internal memory for max. 3 x 255 scenes  
The application allows you to manage colours, speed and channels.  
Activation by external contacts  
Calendar function  
Operating system: Windows & MAC OSX & Linux  
DMX outputs on XLR power connectors:  
Supplied with external power supply (9 to 36 V) for use in standalone mode



### LD-1024DIN

DMX interface 1024 channels in DIN rail format. For CHROMATEQ software

Code : B05013



Interface in DIN rail format  
1024 DMX channels  
Compatible with "Chromateq Led Player" and "Chromateq Pro DMX" software. (supplied)  
Internal 4MB memory for storing programs.  
Internal memory for max. 255 scenes  
Activation by external contacts or optional remote control  
Calendar function  
Splitter mode 2x512  
Merger mode  
Chaining in Master/Slave possible  
Operating system: Windows & MAC OSX & Linux  
DMX inputs and outputs on connectors.  
Power supply: By mini USB 5V or DC 9-36V  
Art-Net Universe available: 1



### LD-512KIT-IR

Infrared set for CHROMATEQ interfaces

Code : B05011



Infrared set including 2 wireless remotes and 1 IR receiver board that can be installed anywhere in the room. Remote controls can also be used with LD standalone interfaces already integrating an IR receiver.



# CONTROLLERS

Software available in full French version

Windows  
macOS

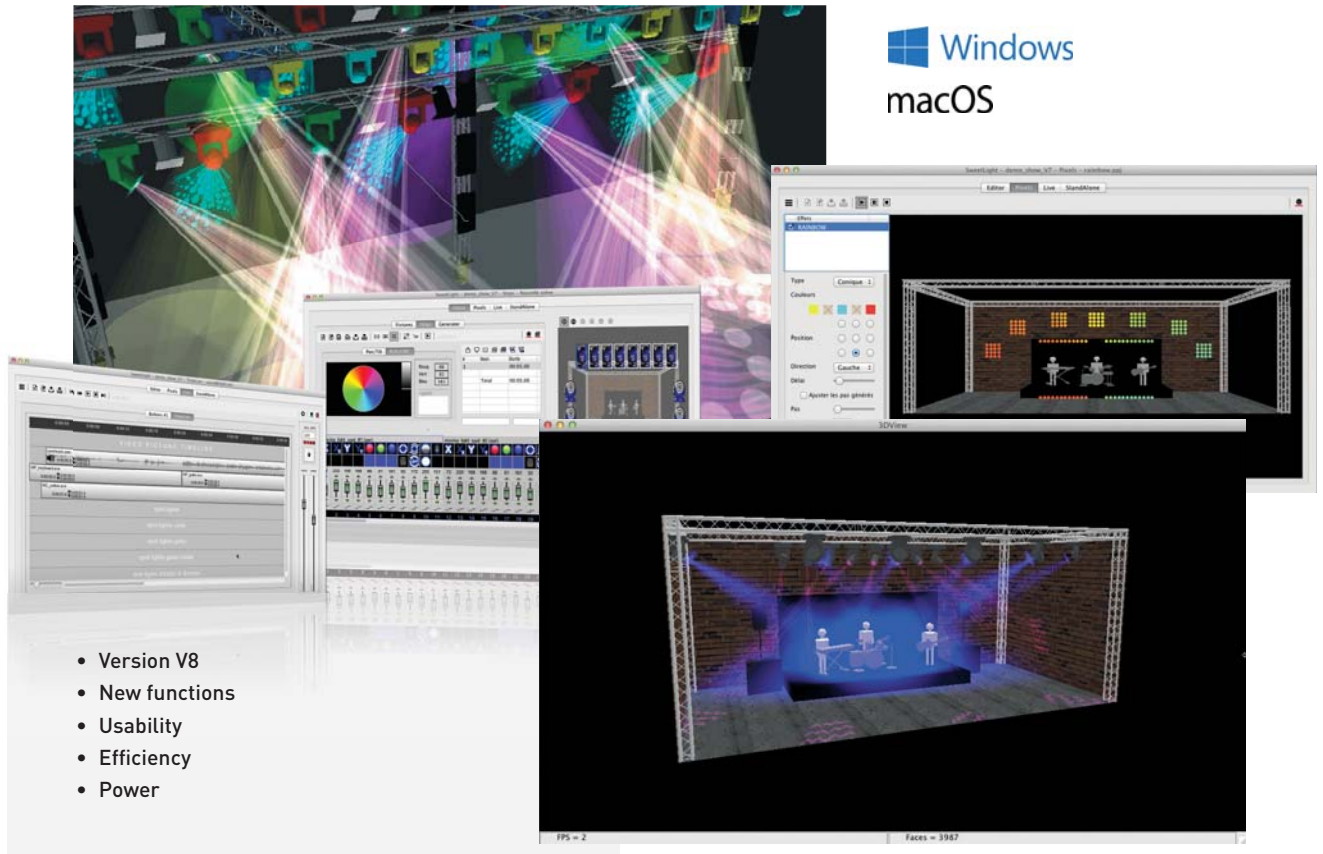

- Version V8
- New functions
- Usability
- Efficiency
- Power

Windows  
macOS



**SWEETRACK**  
The ultimate 19-inch interface. For SWEET-LIGHT software

Code : H10485



Standalone interface capable of storing 18 scenes/chases.  
16 programs (previously programmed on Sweet Light) accessible and triggerable on the front  
Calendar function  
Indication: Power, USB link, DMX input  
Operating system: Windows & MAC  
Memories: 18  
DMX channel: 512  
DMX output: 3-pin female XLR with optical isolation  
DMX input: 3-pin male XLR with optical isolation  
Power supply: By USB or 9-12V, 300mA AC/DC  
Dimensions: 482 x 136 x 44mm  
Weight: 1.7 Kg

Windows  
macOS



**SWEET REMOTE**  
DMX interface with infrared remote control For SWEETLIGHT software

Code : H9635



Compact interface in a metallic box  
512 DMX channels - Unlimited number of projectors  
Access to 3D and DMX modes simultaneously integrated infrared sensor + connector for offset - Control your scenes from your remote control  
Standalone rendering of 10 scenes of 512 channels (4 simultaneous)  
Internal "date and time" calendar trigger  
Mini-Din connector for external contact triggering  
Windows and MacOS compatible  
Opto-isolated DMX output (surge protection)

Windows  
macOS



**SWEET D512**  
Compact, complete and standalone interface. For SWEETLIGHT software

Code : H9634



Compact interface in a metallic box  
512 DMX channels - Unlimited number of projectors  
Access to 3D and DMX modes simultaneously  
Thermal protection  
USB powered - USB Cable supplied  
Windows and MacOS compatible  
Standalone rendering of a 512-channel scene

Windows



**SWEET CABLE**  
DMX interface on USB stick. For SWEET-LIGHT software

Code : H8287



Compact and self-powered USB interface  
100 DMX channels, up to 20 simultaneous scenes  
Driver up to 10 DMX projectors  
Access to 3D mode or DMX  
Windows compatible

## 1 - SIMPLIFY YOUR LIGHT

- Quick and precise creation of your projectors under Setup
- Library containing most market models and all DMX Contest products
- Sharing your creations with other users on the forum
- Creating scenes with Editor like on traditional consoles
- Possibility of creating pallets to save time.
- Numerous simplification tools (Pan and Tilt with the mouse, RGB colours in 1 click, etc..)

## 2 - SAVE TIME

- Preparation, simulation and creation assisted in a few clicks
- Automatic patch creation, dip-switch position per projector
- Manage projectors in groups with multi-group management
- 3D simulation of your shows
- Possibility of repatching products without loss of programming.

- Creating complex scenes with offset management via Generator
- Record your favourite movements and reproduce them
- Copy, paste and cut your scenes at will

## 3 - MASTER LIVE

- One scene per button, organize your pages according to your needs
- Keyboard shortcuts, grouping, MIDI and DMX control
- Autonomous broadcast interfaces (Sweet-Remote, Sweet-Rack) controlled boot programs
- Simple creation of scenes with DMX, video, music and synchronized animated gifs
- Exemplary stability, even on the most modest configurations
- New Sequential List function

## 4 - BECOME THE ARCHITECT OF YOUR COLOURS

- Import your own visuals of buildings or spaces to showcase
- Determine the placement of your projectors
- Create Chaser, Text and Rainbow effects with ease



### SWEET-TELEC

Infrared remote control.  
For SWEET-REMOTE interface

Code : H9819



18 buttons to launch scenes  
Speed adjustment button:  
- Allows you to reduce the rendering speed of the scene  
+ Allows you to increase the rendering speed of the scene  
= Returns to the default programming speed

	CABLE	D512	REMOTE	RACK
<b>WITH A COMPUTER</b>				
Operating system	Windows	Win/Mac	Win/Mac	Win/Mac
Communication	USB	USB	USB	USB
Number of channels	100	DMX512 + 512 Artnet	DMX512 + 512 Artnet	DMX512 + 512 Artnet
Maximum number of interfaces	1	6	6	6
dmx input				✓
dmx optical isolation			✓	✓
<b>STANDALONE MODE</b>				
Number of dmx channels	0	512	512	512
Number of scenes (dynamic)		1	18	16
Number of zones		1	4	4
Number of push buttons				16
Infrared remote control			✓	
Calendar			✓	✓
External contacts			4	

## LIVE MOBILE

Control the show remotely

Live Mobile is available on AppStore for iPhone, iPad, and on the Market for Android smartphones.

- Download the full software for a FREE TRIAL on our site!
- Download updates, manuals, and tutorials regularly



[WWW.SWEETLIGHT-CONTROLLER.COM](http://WWW.SWEETLIGHT-CONTROLLER.COM)

# CONTROLLERS



## MEMORY-24

24-channel DMX console for power blocks

Code : H9067



Organ playing with 2 courses of 12 circuits or 1 course of 24 circuits  
4,600 memories and 48 programmable sequences  
Crossfade  
Adjustable speed and rise time of sequences  
Backup memories internally  
Possibility of mixing several sequences  
Sound mode  
Manual triggering by Tap synchro  
Triggering scenes and sequences in MIDI  
DMX 512 output on 3-pin XLR plug  
External power supply (DC 9 V - 12 V, 500 mA)  
Dimensions: 483 x 265 x 90mm  
Weight: 4.6 kg



## PILOT-192PRO

192-channel DMX controller with joystick

Code : H9073



192 channels (12 projectors of 16 channels)  
30 banks of 8 programs each  
12 chases (240 steps per chase)  
Pan/Tilt  
Fade Time  
MIDI control of memories and blackout  
Assignable joystick for Pan/Tilt movements  
Connection for foot control and smoke machine  
Sound mode  
Dimensions: 483 x 82 x 135 m  
Weight: 2.2 kg



## SCM-1 SCENEMASTER

16 DMX channels with MIDI output

Code : B04624



64 channels (4 projectors of 16 channels)  
16 scenes of 16 channels  
MIDI control of faders and flashes  
Midi In controls scenes with compatible software  
16 buttons for flashes or scenes  
Dimensions: 483 x 85 x 133 m  
Weight: 2.5 kg



## LEDCON-XL

LEDCON-XL controller

Code : B04661



64 channels (8 projectors with 8 channels each) patchable  
Control of colours, fades and chases.  
8 faders for other functions  
4- or 8-channel modulators with speed control or sound mode  
Choice of RGB, white RGB, amber white RGB modes, etc.  
UV button for 6-in-1 LED projectors that include a UV LED.  
Separate control for strobe and dimmer.  
Instant access to 9 preprogrammed colour chasers  
Static or audio chaser mode 32-colour spectral blend.  
Dimensions: 483 x 75 x 133 m  
Weight: 2.2 kg



## CONTROLLER CASE 3U

Compact flight case for all kinds of small 19" controllers

Code : B03224

Compact flight case for controllers  
19" up to 3U  
Accessory compartment  
Rubber feet





### PILOT-8

Programmable 8x8 channels controller

Code : H10126



64 patchable channels (8 projectors with 8 channels each)  
 8 colours recorded and 24 free  
 8 pre-programmed colours and 24 free  
 Assignable patch for RGBWA and dimmer functions  
 2 assignable free channels  
 Strobe function  
 Adjustable sequence speed  
 Connectors:  
 - DMX output on XLR  
 - RJ45 for DMX control of the Contest Architecture range using the PILOT  
 - Jack for external controller Easy-2 for launching programs, choice of colours and Blackout  
 - USB for the night light supplied  
 Dimensions: 400 x 200 x 68 mm  
 Weight: 2.3 kg



### MANU-6X

DMX 6 channels + master controller

Code : H9064



6-channel DMX console  
 6 faders + Master  
 Operates on 9 V battery  
 Supplied AC adapter  
 Ideal for the control of architectural colour changers  
 DMX output: 3-pin XLR  
 Dimensions: 173 x 153 x 55 mm  
 Weight: 0.8 kg



### PARCONTROL34

RGB and RGBW compatible DMX controller

Code : H9913



Control of colour, prog, strobe.  
 Direct access to 12 colours and 3 shades of whites  
 RGBW colour graduation  
 Audio mode  
 Strobe speed  
 2 control modes  
 Mode 1: R,G,B, Dim/Strobe, White  
 Mode 2: R,G,B,White  
 Power supply: DC 9-12V 300mA  
 Dimensions: 270 x 170 x 60 mm  
 Weight: 1.1 Kg



### PARCONTROL

DMX controller for RGB projector

Code : H9406



Control of colour, prog, strobe.  
 Direct access to 9 colours  
 RGB colour graduation  
 Audio mode  
 Strobe speed  
 Fixed patch R, G, B, Dimmer/Strobe.  
 Power supply: DC 9-12V 300mA  
 Dimensions: 220 x 140 x 36 mm  
 Weight: 1 Kg



### LEDCON-02 Mk2

Small pre-programmed LED controller

Code : B04660



Control of colour, prog, strobe.  
 Direct access to 9 colours  
 Faders for chasers, speed and Dimmer  
 Audio mode  
 Fixed patch R,G,B, Dimmer/Strobe  
 Works in 4 or 8 channel mode  
 Power supply: DC 9-12V 300mA  
 Dimensions: 210 x 140 x 46 mm  
 Weight: 1 Kg



### PARPILOT

DMX control box for PAR LEDs CONTEST and LED4STAGE

Code : H9658



Control of colour, prog, strobe.  
 2 control modes: Fixed colour and running light  
 Fixed patch R,G,B, Dimmer/Strobe  
 Works in 4 or 16 DMX channels  
 10 pre-memorized internal programs  
 Musical Mode, Tap Tempo and Colour Variation  
 Quick access to 8 fixed colours  
 Management of scroll speed and intensity  
 Strobe effect  
 Net or progressive colour chaining  
 Blackout  
 Power supply: DC 12 V 100 mA (supplied)  
 Dimensions: 70 x 110 x 33 mm  
 Weight: 0.31 kg



# CONTROLLERS



## CA-8

Remote compatible with most lighting effects

Code : B04192



Colour/gobo control of programs and of Blackout.  
Connectivity: 6.35 stereo jack  
Cable length: 11 m



## EASY-2

Universal remote control for Contest devices

Code : H8701



Colour/gobo control of programs and of Blackout.  
Connectivity: 6.35 stereo jack  
Cable length: 11 m



## BT-STR4

4-channel controller for strobes.

Code : B04712



Strobe controller  
Analog outputs and DMX (2-channel)  
Manual or automatic operation 10 different programs  
Single flash, Full on / Blinder, Blackout  
Adjustable speed  
Dimmer (only in DMX)  
Audio mode  
Compatible with analog strobes using 12V DC pulses such as: MEGA STROBE 1500, ...  
Compatible with DMX strobes using 2 channels such as: MEGA STROBE 1500 DMX, BT-STROBE 3000, ...



## FL-01CX

Strobe controller, analog pulses

Code : B02029



1-channel controller for strobes  
Manual or automatic operation  
Adjustable speed: 1 to 12 bursts per second  
Up to 4 possible strobes  
Mono jack/jack cable to be ordered separately (e.g. 2-0426)  
Compatible with: FL1800, STR300, FL045/B, ZAP Strobes



## DMS-26

The perfect all-in-one solution for securing your DMX installations: MERGER + SPLITTER + BOOSTER.

Code : B04625



SPLITTER:  
100% electrical insulation  
2 inputs and 6 DMX outputs  
BOOSTER:  
signal reconstruction  
MERGER:  
Mixer:  
HTP: Priority to the highest value  
Backup: if signal A is faulty then relay on signal B  
Priority channel address per input.  
DMX speed 23 ms to 45 ms.  
Signal loss setting:  
Null, Hold, Clear  
4-character LED display.  
Dimensions: 482 x 150 x 44 mm  
Weight: 2.9 kg



## DS 12

PRO splitter DMX+IEC 1in/2out

Code : B04631



SPLITTER:  
100% electrical insulation  
1 input and 2 DMX outputs  
BOOSTER:  
signal reconstruction  
Bidirectional RDM compatible  
Inputs:  
DMX 3 and 5 XLR  
IEC 10A  
Outputs:  
2 DMX XLR3  
2 IEC 10A  
Dimensions: 130 x 132 x 56 mm  
Weight: 0.95 kg



## SPLIT-2

DMX line splitter of 1 input 2 outputs

Code : H7546



SPLITTER:  
100% electrical insulation  
1 input and 2 DMX outputs  
BOOSTER:  
signal reconstruction  
Inputs:  
DMX 3 and 5 XLR  
Outputs:  
2 DMX 3 and 5 XLR  
Overvoltage protection on each channel by fuse: 500 mA - 250 V  
Signal presence indicators  
Dimensions: 245 x 165 x 72 mm  
Weight: 1.9 kg





**MINI DMX-SPLITTER**  
Mini DMX splitter 1in/2out

Code : B04630



**SPLITTER:**  
100% electrical insulation  
1 input and 2 DMX outputs  
**BOOSTER:**  
signal reconstruction  
Inputs:  
DMX XLR 3  
Outputs:  
2 DMX XLR3  
Dimensions: 102 x 72 x 40 mm  
Weight: 0.24 kg



**airBOX-ER1**  
Wireless DMX transmitter and receiver box of 512 DMX channels and 7 WiFi frequencies

Code : H9966



Transceiver operation in automatic transmitter and receiver  
- ISM 2.400-2.483GHz frequency band  
Channel selection button with tricolour LED  
Choice of 7 different channels to make groups of projectors  
Power supply:  
- AC 100/240 V - 50/60 Hz  
Input and output power  
DMX input and output on XLR3  
Maximum transmission power: 20 dBm/100 mW  
Removable bracket for hanging on structures and wall attachment  
Dimensions: 165 x 120 x 53 mm  
Net weight: 0.5 kg



**M-DMX TRANSCEIVER**  
Wireless DMX! Compatible with WTR-DMX DONGLE.

Code : B04646



Transceiver can operate in transmitter or receiver mode  
- 2.4 GHz frequency band  
Compatible with the "Wireless Solution" W-DMX™ Protocol  
Works perfectly with Briteq WR-DMXG4 (4632) in WT-DMXG4 (4633)  
5V DC power supply via micro USB or adapter included  
DMX input and output on XLR3  
Dimensions: 103 x 76 x 36 mm  
Net weight: 0.250 kg



**WTR-DMX DONGLE**  
The perfect solution for anyone looking for an extremely reliable wireless DMX!

Code : B04645



Transceiver can operate in transmitter or receiver mode  
- 2.4 GHz frequency band  
Compatible with the "Wireless Solution" W-DMX™ Protocol  
Works perfectly with Briteq WR-DMXG4 (4632) in WT-DMXG4 (4633)  
5V DC power supply via USB port  
DMX connection via USB port  
Dimensions: 71 x 42 x 11 mm  
Net weight: 0.02 kg



**FIRMWARE UPDATER**  
This device allows you to do firmware updates on DMX projectors and light effects.

Code : B04319



Firmware update box for compatible devices.  
Works with the software that allows you to load the program via the USB port.  
Possible to update multiple devices in one time.  
Check the compatibility of your device.



**FIRMWARE UPDATER 2**  
Standalone programmer that makes it easy to update the firmware of projectors on site.

Code : B04379



Firmware update box for compatible devices. The update is loaded on the micro-SD card  
Possible to update multiple devices in one time.  
Possible to store firmware files for different projectors.  
Charging the internal battery via a mini USB input.  
Output: 3-pin XLR  
USB stick adapter/micro-SD card  
Supplied with mini USB cable and micro-SD card  
Check the compatibility of your device.



**FIRMWARE UPDATER 3**  
Firmware update cable

Code : B04389



Firmware update cable for compatible devices.  
Works with the software that allows you to load the program via the USB port.  
Possible to update multiple devices in one time.  
Check the compatibility of your device.



**DMS-26**

The perfect all-in-one solution to secure your installations.

# ELECTRICAL DISTRIBUTION



## DIM-6X16

6x16A DMX 6-channel block with faders

Code : H9058



Power rating: 16 A (3500 W) per channel / 96 A max. resistive/inductive  
 Protection of each channel by bipolar circuit breaker  
 LEDs indicating charge presence on each channel  
 DMX addressing Dip Switch  
 6 linear potentiometers for manual dimming  
 Power supply: single-phase or three-phase on internal terminal blocks (230 V - 50 Hz)  
 6 16A French plug outputs on the back  
 DMX input and output: on 3-pin XLR connectors  
 Dimensions: 482 x 390 x 90  
 Weight: 7 kg



## BT-626/FRA

6-channel professional Dimmer/Switch pack for rack mounting 19".

Code : B04634



Power rating: 16 A (3500 W) per channel / 96 A max. resistive/inductive  
 Protection of each channel by circuit breaker  
 LEDs indicating charge presence on each channel  
 Independent addressing of each channel  
 6 linear potentiometers for manual dimming  
 Preheat control of lamps from 0 to 6%  
 LED display to monitor all functions, including internal temperature  
 Power supply: single-phase or three-phase on terminal blocks (230 V - 50 Hz)  
 6 16A French plug outputs on the back  
 DMX XLR 3 and RJ11 input and output  
 0/10V input on DB9  
 Dimensions: 482 x 312 x 90  
 Weight: 8 kg



## BT-626/GER

6-channel professional Dimmer/Switch pack for rack mounting 19".

Code : B04635



Same as BT-626/FRA but with outputs on 6 standard German plugs.



## DSP-4 Mk2 /F

Multifunctional dimmer/switch pack with 4 sockets (French Schuko).

Code : B04643



Power rating: 8 A (1850 W) per channel / 15 A max. resistive/inductive  
 Protection of each channel by fuse  
 Independent addressing of each channel  
 LED display with drop-down menu  
 Power supply: 240V - 50Hz single phase  
 4 16A French plug outputs on the front  
 DMX XLR 3 input and output  
 Dimensions: 482 x 100 x 88  
 Weight: 2.9 kg



## DSP-4 Mk2 /G

Multifunctional dimmer/switch pack with 4 sockets (German Schuko).

Code : B04644



identical to the DSP-4 MK2 but with outputs on 4 standard German plugs.





### DIM-1X10

1-channel 1x10A DMX block with PC output fader

Code : H9061



Power rating: 10 A (2200W) resistive/ inductive  
 Linear potentiometers for manual dimming  
 Cable length of the remote fader: 1.8 m  
 LED display with drop-down menu  
 DMX input/output on 3-pin XLR plugs  
 Output on French plug  
 Power supply: AC 230 V, 50 / 60 hz  
 Dimensions: 150 x 125 x 82 mm  
 Weight: 1.5 kg



### DIM-4X5

4-channel 4 x 5A compact DMX block with faders

Code : H9057



Power rating: 5 A (1100 W) per channel / 16 A max. resistive/inductive  
 16 internal chase programs with variable speed  
 Individual fader per channel, with speed adjustment  
 4 DMX channels with independent assignment in DMX 512  
 Modes: Master/slave, program, DMX, sound via build-in microphone.  
 Switch/dimmer pack  
 Control of 4 DMX channels via faders  
 Outputs on 4 French mains plugs  
 Power supply: AC 120 V / 230 V - 50 / 60 Hz, 16 A maximum  
 Dimensions: 250 x 208 x 68 mm  
 Weight: 2.5 kg



### RG8USB

1U rackable strip, 8 European plugs + 2xUSB

Code : H10840



1U rackable 19" strip with:  
 8 sockets on the back  
 2 USB ports (1A) on the front  
 1 bipolar switch on the front panel to control the outlets  
 Standard German plugs with child protection  
 3G1.5mm<sup>2</sup> cable - length 2m  
 Dimensions: 483 x 46 x 90 mm  
 Power supply: 230V - 50 Hz  
 Weight: 1 kg



### PC-8 Mk2 FRA/BEL

8-channel dispatch with bipolar switches

Code : B02049



Outputs on 8 IP54 outlets  
 Standard French plugs  
 8 bipolar switches  
 6.3 amp fuse for each channel  
 the total charge cannot exceed 15 amps (3300 W)  
 Rackable 19 inches / 2U  
 Dimensions: 483 x 80 x 97 mm  
 Power supply: 230V - 50 Hz  
 Weight: 2 kg



### PC-8 Mk2 GER

8-channel dispatch with bipolar switches

Code : B02059



Outputs on 8 IP54 outlets  
 Standard German plugs  
 8 bipolar switches  
 6.3 amp fuse for each channel  
 the total charge cannot exceed 15 amps (3300 W)  
 Rackable 19 inches / 2U  
 Dimensions: 483 x 80 x 97 mm  
 Power supply: 230V - 50 Hz  
 Weight: 2 kg



### RG2x8

1U double-sided rackable strip, 2x8 European plugs

Code : H10837



1U rackable 19" strip with:  
 8 sockets in front / 16A protection  
 8 sockets at the rear / 16A protection  
 2 front bipolar switches to control front outlets and rear outlets  
 Standard German plugs with child protection  
 3G1.5mm<sup>2</sup> cable - length 2m  
 Dimensions: 483 x 46 x 90 mm  
 Power supply: 230V - 50 Hz  
 Weight: 1.33 kg



# ELECTRICAL DISTRIBUTION



## PD-63SH/FRA-BEL

Distributor 63A Tetra / 12x16A Mono + 2x 16PIN + 2x19PIN + 1 CEE 63A output.

Code : B04647



1 x 63A 4-pole circuit breaker (3P+N) for protection of all outputs, including 63A output  
 1 x 30 mA 63A differential circuit breaker for the protection of persons  
 12 x bipolar circuit breakers for 12 16A standard French outlets (4 outlets per phase)  
 V-meters + A-meters per phase  
 1.5 m mains input cable with CEE 63A plug  
 1 x CEE 63A output connector  
 2 x 16-pin harting type connector  
 2 x 19 pin socapex type connector  
 Dimensions: 482 x 266 x 326 mm  
 Rackable 19" height 6U  
 Power supply: 400V - 50 Hz (3P+N+E)  
 Weight: 11.74 kg



## PD-63SH/GERMAN

Distributor 63A Tetra / 12x16A Mono + 2x 16PIN + 2x19PIN + 1 CEE 63A output.

Code : B04648



1 x 63A 4-pole circuit breaker (3P+N) for protection of all outputs, including 63A output  
 1 x 30 mA 63A differential circuit breaker for the protection of persons  
 12 x bipolar circuit breakers for 12 16A standard German outlets (4 outlets per phase)  
 V-meters + A-meters per phase  
 1.5 m mains input cable with CEE 63A plug  
 1 x CEE 63A output connector  
 2 x 16-pin harting type connector  
 2 x 19 pin socapex type connector  
 Dimensions: 482 x 266 x 326 mm  
 Rackable 19" height 6U  
 Power supply: 400V - 50 Hz (3P+N+E)  
 Weight: 11.74 kg



## PD-63A Mk2/FRA-BEL

Distributor 63A Tetra / 2 x outputs CEE 32A + 3 x 16A Mono.

Code : B04639



1 x 30 mA 63A differential circuit breaker for the protection of persons  
 2 x 32A 4-pole circuit breakers (3P+N) for the protection of two P17 32A outputs  
 3 x bipolar circuit breakers for 3 16A standard French outlets (1 outlet per phase)  
 V-meters + A-meters per phase  
 1.5 m mains input cable with CEE 63A plug  
 2 x CEE 32A output connectors  
 Dimensions: 482 x 274 x 152 mm  
 Rackable 19" height 3U  
 Power supply: 400V - 50 Hz (3P+N+E)  
 Weight: 11.74 kg



## PD-63A Mk2/GER-NL

Distributor 63A Tetra / 2 x outputs CEE 32A + 3 x 16A Mono.

Code : B04640



1 x 30 mA 63A differential circuit breaker for the protection of persons  
 2 x 32A 4-pole circuit breakers (3P+N) for the protection of two P17 32A outputs  
 3 x bipolar circuit breakers for 3 16A standard German outlets (1 outlet per phase)  
 V-meters + A-meters per phase  
 1.5 m mains input cable with CEE 63A plug  
 2 x CEE 32A output connectors  
 Dimensions: 482 x 274 x 152 mm  
 Rackable 19" height 3U  
 Power supply: 400V - 50 Hz (3P+N+E)  
 Weight: 11.74 kg



### PD-32SH/FRA-BEL

Distributor 32A Tetra / 6 x 16A Mono + 1 x 16PIN + 1x19PIN + 1 x CEE 32A output.

Code : B04636



1 x 30 mA 32A differential circuit breaker for the protection of people  
 1 x 32A 4-pole circuit breaker (3P+N) for protection of all outputs, including the 32A output  
 6 x bipolar circuit breakers for 6 16A standard French outlets (2 outlets per phase)  
 V-meters + A-meters per phase  
 1.5 m mains input cable with CEE 32A plug  
 1 x CEE 32A output connector  
 2 x 16-pin harting type connector  
 2 x 19 pin socapex type connector  
 Dimensions: 482 x 258 x 152 mm  
 Rackable 19" height 3U  
 Power supply: 400V - 50 Hz (3P+N+E)  
 Weight: 8.78 kg



### PD-32SH/GERMAN

Distributor 32A Tetra / 6 x 16A Mono + 1 x 16PIN + 1x19PIN + 1 x CEE 32A output.

Code : B04637



1 x 30 mA 32A differential circuit breaker for the protection of people  
 1 x 32A 4-pole circuit breaker (3P+N) for protection of all outputs, including the 32A output  
 6 x bipolar circuit breakers for 6 16A standard German outlets (2 outlets per phase)  
 V-meters + A-meters per phase  
 1.5 m mains input cable with CEE 32A plug  
 1 x CEE 32A output connector  
 2 x 16-pin harting type connector  
 2 x 19 pin socapex type connector  
 Dimensions: 482 x 258 x 152 mm  
 Rackable 19" height 3U  
 Power supply: 400V - 50 Hz (3P+N+E)  
 Weight: 8.78 kg



### BREAK-3X32

3x32A power supply block on 6 outlets and 1CEE32 - vu-meter

Code : H9070



1 x 30 mA 32A differential circuit breaker for the protection of people  
 6 x bipolar circuit breakers for 6 16A standard French outlets (2 outlets per phase)  
 V-meters + A-meters per phase  
 AC input cable with CEE 32A plug  
 1 x CEE 32A output connector  
 Dimensions: 482 x 260 x 152 mm  
 Rackable 19" height 3U  
 Power supply: 400V - 50 Hz (3P+N+E)  
 Weight: 7 kg



### BREAK-3X16

3x16A power supply block on 6 outlets with vu-meter

Code : H9059



3 x bipolar circuit breakers for 6 16A standard French outlets (2 outlet per phase)  
 V-meters + A-meters per phase  
 1 x CEE 32A input connector  
 1 x 16A socket in front on phase 1  
 Dimensions: 482 x 260 x 152 mm  
 Rackable 19" height 2U  
 Power supply: 400V - 50 Hz (3P+N+E)  
 Weight: 3.8 kg



# ELECTRICAL DISTRIBUTION

**NEW**



**DIST3x2F**  
TRI 1xCEE16A distributor - 3x2 French outlets

---

Code : H10838

---

**Contest** 

**NEW**



**DIST3x2E**  
TRI 1xCEE16A distributor - 3x2 European outlets

---

Code : H10839

---

**Contest** 

**NEW**



**DIST-CUBE**  
Tri 1xCEE16A distributor / 3 x European outlets

---

Code : H10868

---

**Contest** 

Rackable distributor 19" height 1U  
Power input cable in 5G1.5mm<sup>2</sup> with a length of 2 m + Tetra CEE 16A plug  
6 16A standard French sockets on the front (2 outlets per phase)  
Weight: 1.1 Kg

Rackable distributor 19" height 1U  
Power input cable in 5G1.5mm<sup>2</sup> with a length of 2 m + Tetra CEE 16A plug  
6 16A standard German sockets on the front (2 outlets per phase)  
Weight: 1.1 Kg

Cube format distributor  
2 M10inserts  
Tetra CEE 16A input plug  
3 16A standard German plugs (1 outlet per phase)  
Dimensions: 160 x 136 x 102 mm  
Weight: 0.86 Kg



# LIFTING CONTROL



## RICO-V8

8-channel chain lift motor controllers with separate UP / DOWN buttons and master / slave function.

Code : B07000



Standalone controller for chain lift motors. Control up to 8 motors independently. Compatible with the RICO-V4 model. Multiple units can be connected as master/slave. Simultaneous control of the hoists using the UP/DOWN buttons on the master controller. Emergency stop. "Slave" LED indicator light. Manual phase inversion switch for each output. Choice of different outputs: 4 16 A outputs, 4 individual CEE poles. 2x 16-pin connectors, Harting® type. 2x 19-pin connectors, Socapex® type. 1x PowerCON 16 A power outlet. XLR input for the remote control [RICO-REMOTE] (optional). Phase indicators available. A 4-pole 32A circuit breaker protects ALL outlets, including the 32A output to the next unit in the chain. In case of emergency, all the phases AND the neutral are disconnected. 2x C16 bipolar automatic circuit breakers (16 A - 1P+N) for the protection of circuits + auxiliary output. AC input cable (3 x 32 A, 5 wires), equipped with CEE 32 A input socket (3P+N+T). Output connector bypass (3 x 32 A, 5 wires) of EEC type (3P+N+T) (19 inches)/4 U rugged metallic box. Designed and manufactured in Europe. Dimensions: 482 x 184 x 430 mm. Power supply: 400V - 50 Hz (3P+N+E). Weight: 13.5 kg.



## RICO-V4

4-channel chain lift motor controllers with separate UP / DOWN buttons and master / slave function.

Code : B04649



Standalone controller for chain lift motors. Control up to 4 motors independently. Multiple units can be connected as master/slave. Simultaneous control of the hoists using the UP/DOWN buttons on the master controller. Emergency stop. "Slave" LED indicator light. Manual phase inversion switch for each output. Choice of different outputs: 4 16 A outputs, 4 individual CEE poles. 1x 16-pin connectors, Harting® type. 1x 19-pin connectors, Socapex® type. 1x PowerCON 16 A power outlet. XLR input for the remote control [RICO-REMOTE] (optional). Phase indicators available. A 4-pole 32A circuit breaker protects ALL outlets, including the 32A output to the next unit in the chain. In case of emergency, all the phases AND the neutral are disconnected. 2x C16 bipolar automatic circuit breakers (16 A - 1P+N) for the protection of circuits + auxiliary output. AC input cable (3 x 32 A, 5 wires), equipped with CEE 32 A input socket (3P+N+T). Output connector bypass (3 x 32 A, 5 wires) of EEC type (3P+N+T) (19 inches)/4 U rugged metallic box. Designed and manufactured in Europe. Dimensions: 482 x 184 x 430 mm. Power supply: 400V - 50 Hz (3P+N+E). Weight: 13.5 kg.



## RICO-REMOTE

Remote control for RICO-V4 and RICO-V8

Code : B04650



Equipped with:  
2 UP / DOWN buttons  
1 backlit emergency stop button  
1 6.5m cable (XLR 5pin male / female)

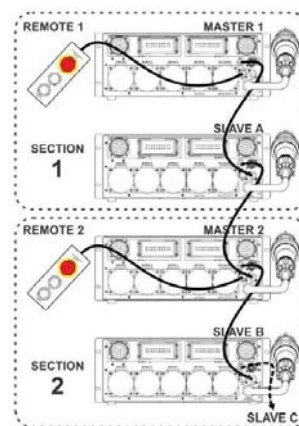





# EFFECT MACHINES

SMOKE, FOG, BUBBLE AND SNOW  
MACHINES  
PERFUMES AND LIQUIDS





# EFFECT MACHINES

**F-7 Smaze**  
All-in-one solution: fog and mist modes

Code : B04844



Tank: 5 litres  
 Preheating time: 8 minutes  
 Output volume:  
 Fog mode: 650 m3 per minute  
 Faze mode: 170 m3 per minute  
 Max. consumption  
 Fog mode: 140 ml/min  
 Faze mode: 28 ml/min  
 Control panel: LCD screen, smoke volume and diffusion fan speed management  
 DMX mode: 3 channels  
 Integrated DMX wireless receiver:  
 Use liquid:  
 Power supply: 230V - 50Hz  
 Power consumption: 1650W max.  
 Dimensions: 710 x 412 x 710 mm  
 Net weight: 52.5 Kg



**HZ-500**  
Hazer machine

Code : B04817



Tank: 2.5 litres  
 Output volume: 85 m3 per minute  
 Max. consumption: 1.1ml/min  
 Control panel: LCD display  
 Volume and Timer Mode  
 DMX mode: 1 channel  
 Noise level: lower than 70 dB from 10cm  
 Use hazer liquid HZL-5  
 Power supply: 230V - 50Hz  
 Power consumption: 480W max.  
 Dimensions: 490 x 351 x 338 mm  
 Net weight: 31.5 Kg



**HZ-350**  
Hazer machine

Code : B04826



Tank: 2.5 litres  
 Output volume: 57 m3 per minute  
 Max. consumption: 0.8 ml/min  
 Control panel: LCD display  
 Volume and Timer Mode  
 DMX mode: 1 channel  
 Wireless remote included  
 Use hazer liquid HZL-5  
 Power supply: 230V - 50Hz  
 Power consumption: 390 W max.  
 Dimensions: 492 x 273 x 314.5 mm  
 Net weight: 14.2 Kg



**F-5D**  
Fazer machine trustworthy and efficient.

Code : B04846



Heating element: 800W  
 Preheating time: 4 minutes  
 Tank: 2.8 litres  
 Output volume: 85 m3 per minute  
 Max. consumption 3ml/min at 100%  
 Control panel: LCD screen, smoke volume and diffusion fan speed management  
 DMX mode: 2 channels  
 Integrated DMX wireless receiver:  
 Use liquid:  
 Power supply: 230V - 50Hz  
 Power consumption: 800W max.  
 Dimensions: 535 x 465 x 225 mm  
 Net weight: 22.9 Kg



**HAZETEC**  
Smoke / Fazer machine

Code : H10487



Heating element: 1400W (preheating), 90W (operation)  
 Preheating time: 46 seconds  
 Tank: 6 litres  
 Output volume: 99m3 per minute  
 Max. consumption 17ml/min at 100%  
 Control panel with smoke volume and diffusion fan speed management  
 2 DMX channels: Smoke volume and diffusion fan speed  
 Use liquid:  
 Power supply: 230V - 50Hz  
 Power consumption: 900W max.  
 Dimensions: 343 x 364 x 290 mm  
 Net weight: 11.9 Kg



**FLY-HAZETEC**  
Flight case for HAZETEC

Code : H10510







### FazeTEC

Hazer 700W

Code : H10204



Heating element: 700W  
 Preheating time: 4 minutes  
 Tank: 1.3 litres  
 Output volume: 85m<sup>3</sup>/min  
 Max. consumption: 3ml/min at 100%  
 Control panel with smoke volume and fan management  
 2 DMX channels: Smoke/fan  
 Use liquid: HD5L  
 Power supply: 230V - 50Hz  
 Power consumption: 900W max.  
 Dimensions: 320 x 153 x 391 mm  
 Net weight: 8.8 kg



### CTL-FazeTec

Remote Volume/On/Off for FazeTEC

Code : H10246



Wired remote for FazeTEC  
 Connector: stereo jack 6.35 mm  
 Function: Volume, start/stop



### Z-380

Hazer machine

Code : B04847



Heating element: 1500W  
 Preheating time: 1.5 minutes  
 Tank: 1.2 litres  
 Output volume: 170m<sup>3</sup>/min  
 Max. consumption: 6 ml/min at 100%  
 Control panel with smoke volume and fan management  
 DMX mode: 1 or 2 channels  
 Use liquid:  
 Power supply: 230V - 50Hz  
 Power consumption: 1500W  
 Dimensions: 328 x 248 x 265 mm  
 Net weight: 8.48 kg



### Z-350

Fazer

Code : B04828



Heating element: 700W  
 Preheating time: 4 minutes  
 Tank: 1.3 litres  
 Output volume: 85m<sup>3</sup>/min  
 Max. consumption: 3ml/min at 100%  
 Control panel with smoke volume and fan management  
 2 DMX channels: Smoke/fan  
 Use liquid:  
 Power supply: 230V - 50Hz  
 Power consumption: 900W max.  
 Dimensions: 320 x 153 x 391 mm  
 Net weight: 8.8 kg



### Z-3

ANTARI wired remote Z-350

Code : B04829



Wired remote for Z-350  
 Connector: stereo jack 6.35 mm  
 Function: Volume, start/stop



### FAZE-700

Fazer

Code : B04891



Heating element: 700W  
 Preheating time: 3 minutes  
 Tank: 1.2 litres  
 Output volume: 39.65 m<sup>3</sup>/min  
 Adjustable fog output:  
 Via the integrated control panel.  
 Via wired remote (included).  
 Use liquid: FOG LIQUID HI-TECH or FOG LIQUID STD  
 Power supply: 230V - 50Hz  
 Power consumption: 700W  
 Dimensions: 300 x 147 x 290 mm  
 Net weight: 5 kg



# EFFECT MACHINES

**NEW**



**FT-200**  
Smoke machine - 1600 W designed for fire training

Code : B04881





**FT-100**  
Smoke machine - 1500 W designed for fire training

Code : B04880



**NEW**



**FT-20**  
Portable smoke machine 600 W on batteries designed for fire training

Code : B04882



Heating element: 1600W  
Preheating time: 7 minutes  
Tank: 2.4 litres  
Max. consumption 270 ml/min at 100%  
Coverage: Height 8 metres  
Control panel: LCD display  
Volume and Timer Mode  
DMX mode: 1 channel  
Wireless W-2 remote included  
Z-3 remote optional  
Use liquid FLP-6  
Power supply: 230V - 50Hz  
Power consumption: 1600 W max.  
Dimensions: 301 x 194 x 414 mm  
Net weight: 16 Kg

Heating element: 1500W  
Preheating time: 7.5 minutes  
Tank: 6 litres  
Max. consumption 100 ml/min at 100%  
Output volume: 560 m3 per minute  
Control panel: LCD display  
Volume and Timer Mode  
DMX mode: 1 channel  
Wireless W-2 remote included  
Z-3 remote optional  
Use liquid FLP-6  
Power supply: 230V - 50Hz  
Power consumption: 1500 W max.  
Dimensions: 580 x 278 x 264 mm  
Net weight: 14.6 Kg

Heating element: 600W  
Battery: DC 12V  
Preheating time: 1 sec  
Tank: 0.4 litres  
Max. consumption 16 ml/min at 100%  
Control panel:  
Manual: on/off  
DMX mode: 1 channel  
WTR-20 optional  
Z-3 remote optional  
Use liquid FLP-6  
Charger: AC 230V - 50Hz / DC 12V  
Power consumption: 600 W max.  
Dimensions: 580 x 278 x 264 mm  
Net weight: 14.6 Kg



**NEW**



**WTR-20**

Wireless transmitter and receiver 433MHz

Code : B04883



1 x W-2 transmitter  
1 x W-2 receiver  
frequencies: 315MHz and 433MHz



**W-515D**

Smoke machine 1500W

Code : B04842



Heating element: 1500W  
Preheating time: 10 minutes  
Tank: 6 litres  
Output volume: 566 m3/min  
Max. consumption: 10 min/litre at 100%  
Wireless remote included  
Control panel: LCD display  
Management: Volume, Timer  
DMX mode: 1 channel  
Integrated DMX wireless receiver  
Use liquid: FLG-5  
Power supply: 230V - 50Hz  
Power consumption: 1500W max.  
Dimensions: 561 x 278 x 186 mm  
Net weight: 14 kg



**W-530D**

Smoke machine 3000 W

Code : B04843



Heating element: 3000W  
Preheating time: 12 minutes  
Tank: 6 litres  
Output volume: 1132 m3/min  
Max. consumption: 6 min/litre at 100%  
Wireless remote included  
Control panel: LCD display  
Management: Volume, Timer  
DMX mode: 1 channel  
Integrated DMX wireless receiver  
Use liquid: FLG-5  
Power supply: 230V - 50Hz  
Power consumption: 3000W max.  
Dimensions: 581 x 278 x 186 mm  
Net weight: 14 kg



**Z-3000 II**

Smoke machine 3000W + remote

Code : B04809



Heating element: 3000W  
Preheating time: 12 minutes  
Tank: 6 litres  
Output volume: 1132 m3/min  
Max. consumption: 200 ml/min at 100%  
Detachable control panel:  
Management: Volume, Timer, Manual  
DMX mode: 1 channel  
Use liquid: FLG-5  
Power supply: 230V - 50Hz  
Power consumption: 3000W max.  
Dimensions: 581 x 278 x 186 mm  
Net weight: 14 kg



**Z-1500 II**

Smoke machine 1500W + remote

Code : B04808



Heating element: 1500W  
Preheating time: 9.5 minutes  
Tank: 6 litres  
Output volume: 566 m3/min  
Max. consumption: 110 ml/min at 100%  
Detachable control panel:  
Management: Volume, Timer, Manual  
DMX mode: 1 channel  
Use liquid: FLG-5  
Power supply: 230V - 50Hz  
Power consumption: 1500W max.  
Dimensions: 688 x 285 x 257 mm  
Net weight: 14 kg

**NEW**



**Z-30PRO-433**

Wireless control module for Z-1500II / Z-3000II

Code : B04827



**Z-1200 II**

Smoke machine 1200W + remote

Code : B04807



Heating element: 1200W  
Preheating time: 9.5 minutes  
Tank: 2.5 litres  
Output volume: 510 m3/min  
Max. consumption: 90 ml/min at 100%  
Control panel:  
Management: Volume, Timer, Manual  
DMX mode: 1 channel  
Use liquid: FLG-5  
Power supply: 230V - 50Hz  
Power consumption: 1200W max.  
Dimensions: 458 x 243 x 251 mm  
Net weight: 10.9 kg

# EFFECT MACHINES



## Smotec1500

Smoke machine DMX 1500W  
With HF remote and control panel

Code : H9577



Heating element: 1500W  
Preheating time: 8 minutes  
Tank: 10 litres  
Output volume: 566 m3/min  
Max. consumption: 8.6 litres / hour  
RF Remote control: on/off  
Control panel: output interval + volume controls  
DMX channel: 1  
Use liquid:  
Power supply: 230V - 50Hz  
Power consumption: 1600W max.  
Dimensions: 668 x 319 x 170 mm  
Net weight: 15 kg



## Smotec1000

Smoke machine DMX 1000W  
With HF remote and Timer

Code : H9576



Heating element: 1000W  
Preheating time: 12 minutes  
Tank: 2.8 litres  
Output volume: 283m3 / minute  
Max. consumption: 2.5 litres / hour  
RF Remote control: on/off  
Control panel: output interval + volume controls  
DMX channel: 1  
Use liquid:  
Power supply: 230V - 50Hz  
Power consumption: 1100W max.  
Dimensions: 468 x 250 x 148 mm  
Net weight: 11.4 kg



## Smotec800

Smoke machine 800W  
With timer remote

Code : H9575



Heating element: 800W  
Preheating time: 1.5 minutes  
Tank: 0.8 litre  
Output volume: 85m3/minute  
Consumption type: 0.6 litre / hour  
Remote control : With duration and interval setting from 5 to 200 seconds  
Use liquid: HD5L  
Power supply: 230V - 50Hz  
Power consumption: 900W max.  
Dimensions: 315 x 128 x 165.5 mm  
Net weight: 3.5 kg



## FX-1200

Smoke machine - 1200W

Code : B04895



Heating element: 1200W  
Preheating time: 5 minutes  
Tank: 2.5 litre  
Output volume: 510 m3/minute  
Wired and wireless remote included  
Use liquid: FOG LIQUID HI-TECH or FOG LIQUID STD  
Wireless FC-5 remote optional  
Power supply: 230V - 50Hz  
Power consumption: 1200W max.  
Dimensions: 475 x 253 x 200 mm  
Net weight: 6.55 kg



## FX-700

Smoke machine - 700 W

Code : B04818



Heating element: 700W  
Preheating time: 5 minutes  
Tank: 0.8 litres  
Output volume: 70 m3/minute  
Wired remote included  
Use liquid: FOG LIQUID HI-TECH or FOG LIQUID STD  
Wireless FC-5 remote optional  
Power supply: 230V - 50Hz  
Power consumption: 700W max.  
Dimensions: 330 x 160 x 130 mm  
Net weight: 3.65 kg



## FC-5

Wireless remote for FX-700

Code : B04819



Wireless remote for F-80Z, FX-700 and FX-100  
The receiver's magnetic housing can be attached to the smoke machine  
Range: ± 30m



### FIRE FOG

Smoke machine equipped with 3 amber LED lights to colour smoke

Code : B04890



### MAGICAN

Fog in a tank!

Code : B04833



Heating element: 400W  
 Preheating time: 3 minutes  
 Tank: 0.5 litre  
 Output volume: 57 m<sup>3</sup>/minute  
 Max. consumption: 4 ml/min  
 Wired remote included  
 Use liquid: FOG LIQUID HI-TECH or FOG LIQUID STD  
 Power supply: 230V - 50Hz  
 Power consumption: 400W max.  
 Dimensions: 240 x 120 x 163 mm  
 Net weight: 1.81 kg

Very original.  
 Fog in a tank!  
 For use in small rooms  
 Always ready for use  
 Non-toxic, non-irritating, does not damage ozone layer



### M-7 RGBA

Vertical smoke machine with an intense output to simulate CO<sub>2</sub> effects.

Code : B04845



Light source: 22 3W LEDs  
 5 red, 6 green, 6 blue, 5 amber  
 Heating element: 1550W  
 Preheating time: 5 minutes  
 Tank: 2.5 litres  
 Max. consumption: 25 ml/ 10s at 100%  
 Functions with liquid FLC-5  
 HF remote with 4 programmable buttons  
 - Control panel with emission interval, smoke volume and LED management  
 DMX mode: 9 channels  
 Can operate in both vertical and horizontal position  
 Power supply: 230V - 50Hz  
 Power consumption: 1600W max.  
 Dimensions: 340 x 195 x 380 mm  
 Net weight: 10.9 kg



### GeyTEC

Geyser machine with 22 3W LEDs - 1550W

Code : H10202



Light source: 22 3W LEDs  
 8 red, 7 green, 7 blue  
 Heating element: 1550W  
 Preheating time: 5 minutes  
 Tank: 2.5 litres  
 Max. consumption: 25 ml/ 10s at 100%  
 Functions with rapid dissipation liquid CONTEST® FD5L  
 HF remote with 4 programmable buttons  
 - Control panel with emission interval, smoke volume and LED management  
 DMX mode: 8 channels  
 Can operate in both vertical and horizontal position  
 Power supply: 230V - 50Hz  
 Power consumption: 1600W max.  
 Dimensions: 340 x 195 x 380 mm  
 Net weight: 10.9 kg



### FLY-GeyTECx2

Flight case for 2 GeyTEC or 2 M-7 RGBA

Code : H10337





# EFFECT MACHINES



**Z-1020**  
ANTARI Z-1020 smoke machine

Code : B04806



Heating element: 1050W  
Preheating time: 13 minutes  
Tank: 2.4 litres  
Output volume: 453 m3/min  
Max. consumption: 90 ml/min at 100%  
Wired remote included  
Control panel:  
Management: Manual on/off  
DMX mode: 1 channel  
Use liquid: **FLG-5**  
Power supply: 230V - 50Hz  
Power consumption: 1050W max.  
Dimensions: 408 x 295 x 199 mm  
Net weight: 9.8 kg



**COLOR JET**  
Powerful vertical jet smoke machine with 6 3 W RGB LEDs

Code : B04892



Light source: 6x3W RGB LEDs  
Heating element: 900W  
Preheating time: 4 minutes  
Tank: 2.5 litres  
HF remote with 4 programmable buttons  
DMX mode: 4 channels  
Functions with liquid **FLC-5**  
Power supply: 230V - 50Hz  
Power consumption: 950W max.  
Dimensions: 340 x 250 x 130 mm  
Net weight: 5.5 kg



**BUBBLE-01**  
Bubble machine

Code : B04893



This machine functions with a special ready to use liquid.  
Use liquid: **BUBBLE LIQUID 5L**  
Power supply: 230V - 50Hz  
Power consumption: 30W max.  
Dimensions: 200 x 240 x 210 mm  
Net weight: 1.57 kg



**YETI**  
A powerful 1200W snow machine

Code : B04894



Snow machine 1200 W  
Produces a large amount of artificial snow flakes.  
Adjustable snow output volume  
Wired remote (included).  
Wireless remote (included).  
Recommended liquid **SNOW LIQUID 5L**  
Power supply: 230V - 50Hz  
Power consumption: 1200W max.  
Dimensions: 530 x 260 x 320 mm  
Net weight: 8.7 kg



**S-500**  
Professional snow machine, controlled by DMX and set up in a flight case.

Code : B04848



DMX-controlled air volume and liquid flow  
Tank: 20 litres  
Max. consumption: 400 ml/min at 100%  
Effect output equipped with a 10m air hose.  
Control panel: LCD display  
Volume and Timer Mode  
Integrated DMX wireless receiver:  
DMX mode: 2 channels  
Horizontal movement motor PM-1 (120°) optional  
Power supply: 230V - 50Hz  
Power consumption: 890W max.  
Dimensions: 592 x 551 x 651 mm  
Net weight: 37.2 kg



**PM-1**  
Horizontal movement motor for ANTARI S-500 snow machine.

Code : B04849



Horizontal movement motor (120°)  
Compatible with S-500



**BT-HURRICANE**  
DMX high power fan

Code : B04850



Studio and stage fan controlled by DMX  
Power: up to 3500m<sup>3</sup>/h or 58m<sup>3</sup>/min (2060 cfm)  
Sound level:  
30 dB minimum speed - 72 dB maximum speed  
Air flow direction adjustable over 180°  
Continuous adjustment of air flow  
Control options:  
DMX 1 channel (XLR 3&5 pins)  
Wireless DMX (WTR-DMX DONGLE option)  
Manual operation (LED display)  
Power supply: 230V - 50Hz  
Power consumption: 200W max.  
Dimensions: 584 x 476 x 397mm  
Net weight: 16.5 kg



# PERFUMES AND LIQUIDS

SMOKE LIQUID		
Code	Name	Brand
B04836	FLP-6 - Fog Liquid for FT-100 (fire training) - 6L	ANTARI
B04838	FLG-5 - Heavy Fog Liquid - 5L (green)	ANTARI
H9656	HD5L - 5L high density smoke liquid drum SM CONTEST	CONTEST
B04835	F0G LIQUID HI-TECH 1L - Fogger liquid Hi-Tech, 1L	JB SYSTEMS
B04812	F0G LIQUID HI-TECH 5L - Fogger liquid Hi-Tech, 5L	JB SYSTEMS
B04810	F0G LIQUID STD 1L - Fogger liquid standard, 1L	JB SYSTEMS
B04811	F0G LIQUID STD 5L - Fogger liquid standard, 5L	JB SYSTEMS
H10203	FD5L - Fast dissipating geyser machine liquid - 5L	CONTEST
B04834	FLC-5 - Superfast dissipating Fog for Jet Operation	ANTARI
H10491	MD6L - 6L medium density smoke liquid drum CONTEST	CONTEST
B04832	HZL-5 - Oil based Haze liquid, 5L	ANTARI
B04813	SNOW LIQUID 5L - Liquid for Snow machine 5L	JB SYSTEMS
B04831	FOAM LIQUID CC 20L - Concentrated foam liquid 20L	JB SYSTEMS
B04830	FOAM LIQUID CC 5L - Concentrated foam liquid 5L	JB SYSTEMS
B01911	BUBBLE LIQUID 5L - 5L liquid for bubble machine	JB SYSTEMS
PERFUMES		
H4748	FLAG/MINT - Smoke liquid perfume - Mint	CONTEST
H4749	FLAG/JASMINE - Smoke liquid perfume - Jasmine	CONTEST
H4750	FLAG/FLOWER - Smoke liquid perfume - Orange blossom	CONTEST
H4751	FLAG/APPLE - Smoke liquid perfume - Apple	CONTEST
H4752	FLAG/COCONUT - Smoke liquid perfume - Coconut	CONTEST
H4753	FLAG/VANILLA - Smoke liquid perfume - Vanilla	CONTEST
H4754	FLAG/TROPICAL - Smoke liquid perfume - Tropical	CONTEST
H4755	FLAG/LEMON - Smoke liquid perfume - Lemon	CONTEST
H4756	FLAG/LAVENDER - Smoke liquid perfume - Lavender	CONTEST
H4757	FLAG/STRAWBERRY - Smoke liquid perfume - Strawberry	CONTEST
B04822	Fragrance - Apple - Smoke liquid perfume	JB SYSTEMS
B04820	Fragrance - Coco - Smoke liquid perfume	JB SYSTEMS
B04823	Fragrance - Musk - Smoke liquid perfume	JB SYSTEMS
B04821	Fragrance - Strawberry - Smoke liquid perfume	JB SYSTEMS
B04825	Fragrance - Tutti Frutti - Smoke liquid perfume	JB SYSTEMS

## WARNING

### ONLY USE THE RECOMMENDED SMOKE LIQUIDS FOR YOUR MACHINES.

These liquids are compliant with the latest health and environmental regulations.

These liquids have been specially tested for your machine and guarantee the best possible results.

These are the only liquids that guarantee long term operation, use of other liquids will damage your machine by clogging the heating element and wearing out the pump.

Repairs for clogged heating elements will only be covered after expert evaluation. The warranty will only be valid if the recommended liquid was used.



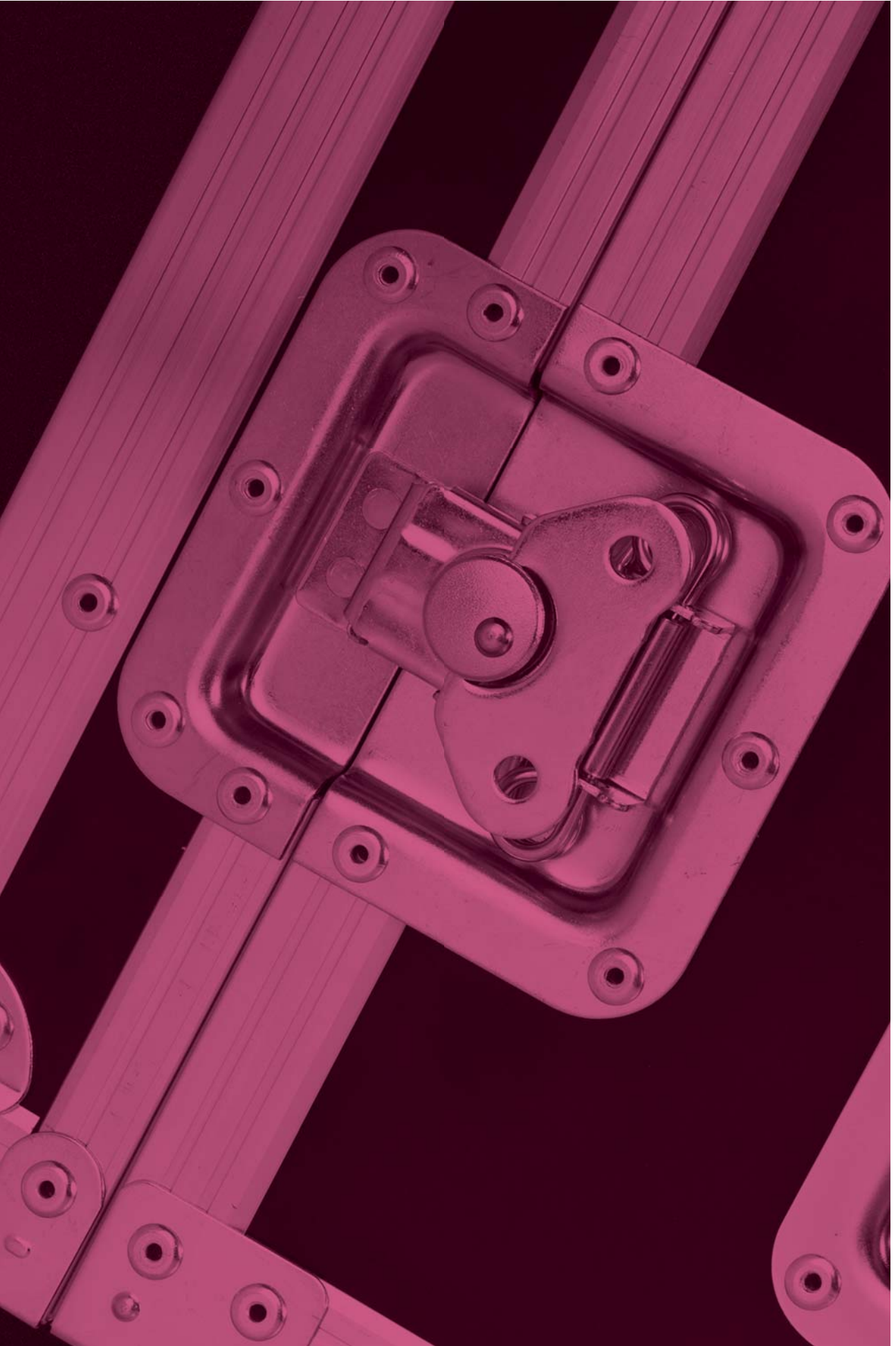

# FLIGHT-CASES

AUDIO FLIGHT-CASES  
FLIGHT-CASES FOR LIGHTS  
19" RACKS



# AUDIO FLIGHT-CASES



**CASE FOR 2x SC-15**  
Flight-case for 2x SC-15.

Code : B03262



**CASE FOR 2x SC-12**  
Flight-case for 2x SC-12.

Code : B03261



**CASE FOR 4x SC-08**  
Flight-case for 4x SC-08

Code : B03260



**CASE FOR 8x SC-05**  
Flight-case for 8x SC-05

Code : B03259



**RACK CASE 10/18U**  
Convenient and versatile Flight-case.

Code : B03240



**CARPET DJ MIXER  
CASE 5U+11U**  
Carpeted DJ Flight-case.

Code : B03200



**TT-CASE**  
High-quality modern flight-case for DJ turntables (T2, T3, X-TRM1, SL1200, etc.).

Code : B03206



**MICRO CASE 3U**  
Standard 19" Flight-case 3U height, reduced depth 230mm/300mm

Code : B03221



**CASE FOR  
CONTROLLER+LAPTOP**  
For 19" controller + laptop.

Code : B03231



**DJ CASE 10/6U**  
Standard 19" Flight-case 6U height + 10U top

Code : B03227



**PRO 445-4U**  
Standard 19" Flight-case 4U height + 10U top

Code : B03222



**CONTROLLER CASE 3U**  
Flight-case for small depth 19" controllers, up to 3U [e.g. PCM-1, LM430, Scenemaster, USB900, etc.]

Code : B03224





# FLIGHT-CASES FOR LIGHTS



**FLY-Beam-Flex15Rx2**  
Flight-case for 2 Evora-Beam/Flex15R

Code : H10343

**Contest** 



**CASE FOR  
2x BTX-TITAN**  
Flight-case for 2x BTX-TITAN

Code : B03251

**JV** 



**MOVING HEAD CASE 3**  
Flight-case for 4x BTX-SATURN

Code : B03273

**JV** 



**FLY2Fusion180**  
Flight-case for 2x FUSION180

Code : H10737

**Contest** 



**CASE FOR  
2x BTX-BEAM 5R**  
Flight-case for 2x BTX-BEAM 5R.

Code : B03239

**JV** 



**CASE FOR  
4x BTX-BEAM 2R**  
Flight-case for 4x BTX-BEAM 2R

Code : B03248

**JV** 



**FLY-RAY1R-  
HEZ0120Zx4**  
Flight-case for 4 RAY1R or 4 HEZ0120Z

Code : H10610

**Contest** 



**CASE for  
4x BT-TRACKER**  
Flight-case for 4x BT-TRACKER.

Code : B03264

**JV** 



**CASE for  
6x BEAM FURY-1**  
Flight-case for 6x BEAM FURY-1

Code : B03265

**JV** 



**FLY-DARTx6**  
Flight-case for 6x DART60 or DART60i ZOOM

Code : H10611

**Contest** 



**CASE FOR  
BEAM WIZARD5x5**  
Flight-case for 2x BT-BEAM WIZARD

Code : B03256

**JV** 



**FLY2FLAG25i**  
Flight-case for 2 x FLAG25i

Code : H10428

**Contest** 



# FLIGHT-CASES FOR LIGHTS



## FLY2ROT0R7i

Flight-case for 2 x ROT0R7i

Code : H10429

**Contest** 



## CASE FOR 2x BT-DAZZLE

Flight-case for 2 x BT-DAZZLE.

Code : B03258

**JVCase** 



## FLY4Hezo300ZR

Flight-case for 4 x HEZO300ZR

Code : H10736

**Contest** 



## CASE FOR 4x BT- W36L3 / BT-W07L12

For 4x BT-W36L3 / 4x BT-W07L12

Code : B03235

**JVCase** 



## MOVING HEAD CASE2

Flight-case for 4x BT-Orbit/BT-W19L10 ZOOM

Code : B03272

**JVCase** 



## CASE FOR 4x STRIKER

Flight-case for 4x STRIKER

Code : B03267

**JVCase** 



## CASE FOR 4x TORNADO 7

Flight-case for 4x TORNADO 7

Code : B03247

**JVCase** 



## Fly4Ninja-S1

Flight-case for 4 x Ninja-7x15QC

Code : H10076

**Contest** 



## CASE FOR 2x BTX-HAWK

Flight-case for 2x Briteq BTX-HAWK

Code : B03263

**JVCase** 



## FLY2CLUB-S1

Flight-case for Typhoon/Thunder/Cyclone/Wave

Code : H10247

**Contest** 



## FLY2CLUB-S2

Flight-case for 2x Storm-8x10

Code : H10248

**Contest** 

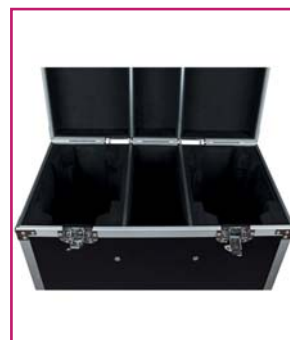

## MOVING HEAD CASE1

Flight-case for 2x BT-METEOR, BT-70LS, BT-BEAM70

Code : B03255

**JVCase** 



**LIGHT EFFECT CASE 4**  
Flight-case for 2x LYNX, 2x BT-20LS,  
2x BT-30FC or 2x BT-W12L10 ZOOM

---

Code : B03225

---





**LIGHT EFFECT CASE 1**  
Flight-case for light effects.

---

Code : B03216

---





**LIGHT EFFECT CASE 3**  
Flight-case for light effects (e.g. 2x LED  
CLUBSCAN OR 2x DYNAMO scan)

---

Code : B03223

---





**LIGHT EFFECT CASE 7**  
Flight-case for The Winner II, Led Victoryscan,  
Led Spinner

---

Code : B03233

---



**PROJECTOR CASE**  
Flight-case for 4x projectors with clamps

---

Code : B03253

---





**PROJECTOR CASE 2**  
Flight-case for POWERPIXEL8-RGB  
POWERPIXEL4-RGB, BEAMBAR10-RGBW,  
BEAMBAR5-RGBW

---

Code : B03257

---





**CASE FOR COB-4BAR**  
Lightweight and compact case, specially  
designed to carry a COB-4BAR

---

Code : B03249

---





**FLY4Sunbar103**  
Flight-case for 4x SUNBAR103W

---

Code : H10738

---



**FLY-FIRESTORMx2**  
Flight-case for 2x FIRESTORM

---

Code : H10339

---



**FLY-HELIWAVEx2**  
Flight-case for 2x HELIWAVE

---

Code : H10340

---





**FLY-HELIPTIC**  
Flight-case for 1x HELIPTIC

---

Code : H10341

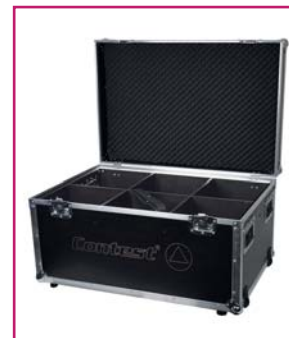
---

**FLY-irLED64x6**  
Flight-case for 6x PAR64

---

Code : H10338

---



# FLIGHT-CASES FOR LIGHTS



## FLY8-irLEDFLAT

Flight-case for 8x FLAT12SIX

Code : H10739



## CASE for 4x COB-PLANO

4x COB-PLANO + LEDCON-02 Mk2

Code : B03252

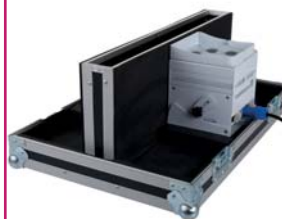

## CASE-2 for 6x ACCU-COLOR

6x ACCU COLOR projectors + accessories

Code : B03268



## FLY-IPairx6

Flight-case for 6x IPair5x12Six

Code : H10464



## FLY4IPANEL

Flight-case for 4 IPANEL24x10QC

Code : H10866



## CASE for 2x BT-VINTAGE

Flight-case for 2x BT-VINTAGE

Code : B03271



## MATRIX5x5-CASE

Flight-case for 6x MATRIX5x5

Code : B04422



## CASE for 6x BT-GLOWPANEL

Flight-case for 6x BT-GLOWPANEL

Code : B03269



## CASE for 8x BT-GLOWBAR

Flight-case for 8x BT-GLOWBAR

Code : B03270



## FLY-GeyTECx2

Flight-case for 2x GeyTEC

Code : H10337



## FLY-HAZETEC

Flight-case for HAZETEC

Code : H10510



## CABLE CASE

Extra solid Flight-case specially designed to carry cables and other heavy objects.

Code : B03244





**NEW**



**FLY4FRESNEL**

For 4 Fresnel 150-250 projectors

Code : H10888



# 19" RACK



**RACK CASE 16U**

Standard 19" Flight-case 16U height, castors included

Code : B03211



**RACK CASE 12U**

Standard 19" Flight-case 12U height, castors included

Code : B03210



**RACK CASE 8U**

Standard 19" Flight-case 8U height

Code : B03209



**RACK CASE 6U**

Standard 19" Flight-case 6U height

Code : B03219



**RACK CASE 4U**

Standard 19" Flight-case 4U height

Code : B03208



**RACK CASE 2U**

Standard 19" Flight-case 2U height

Code : B03212





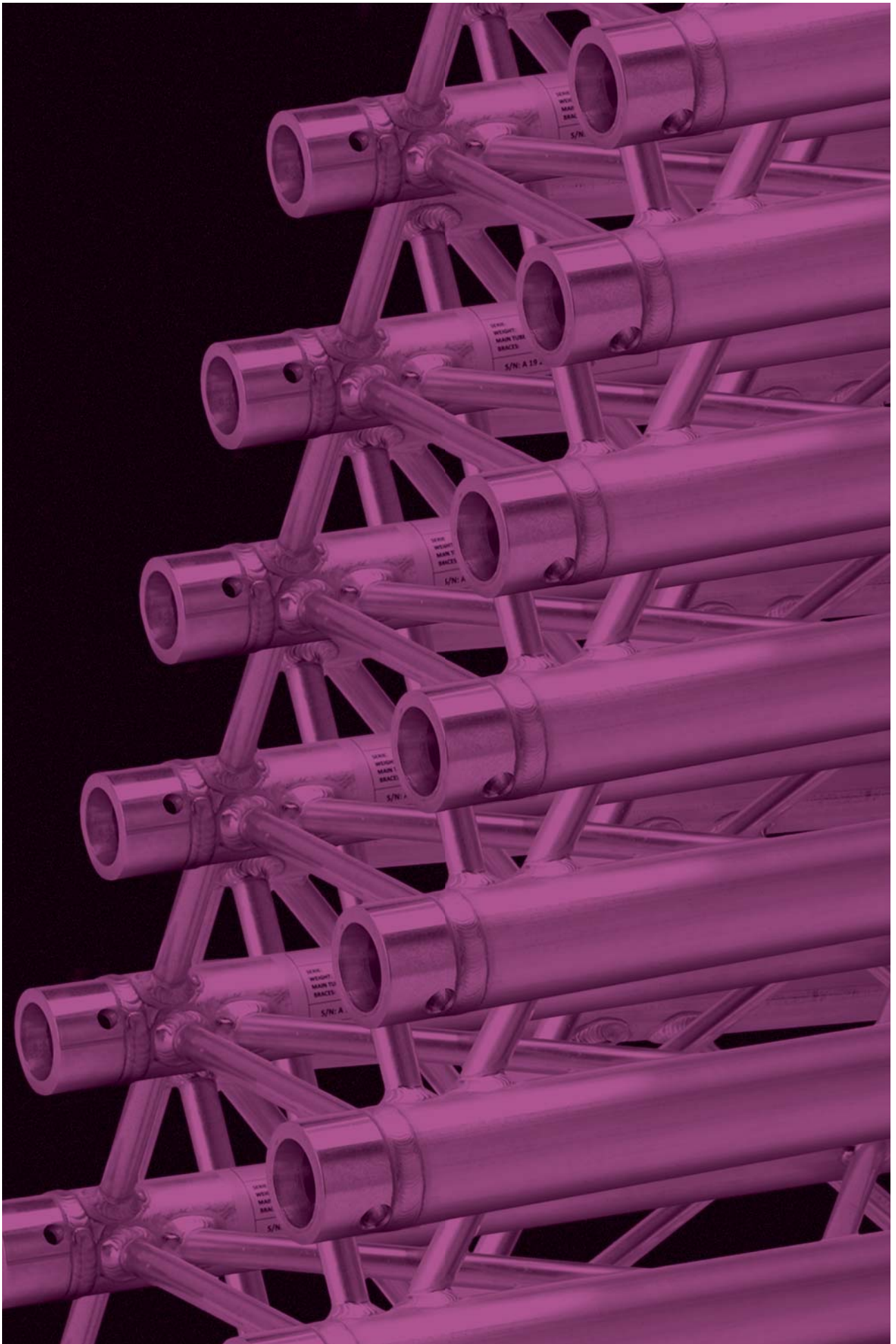

# TRUSSS

QUATRO 290 TRUSS

QUATRO 220 TRUSS

TRIO 290 TRUSS

TRIO 220 TRUSS

TRIO 200 TRUSS

DUO 290 TRUSS

UNO TRUSS

DECO TRUSS

TOTEMS

RIGGING

WINCH STANDS

CABLE CHANNEL

PLATFORMS

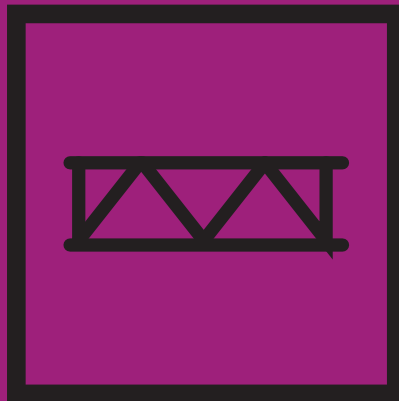

# QUATRO 290 TRUSS



Manufacture according to DIN ISO 4113 and TÜV standards.  
Aluminium alloy truss (EN AW 6082 T6) 50 mm in diameter and 2 mm thick

**50 mm tubes**  
**16 mm braces**  
**Square section with 240 mm spacing between each tube (290 mm exterior)**

**Assembly with conical coupler, spigot pin and Safety R-springs**  
**Section: 290 mm**

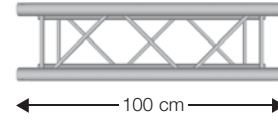
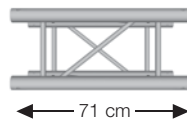
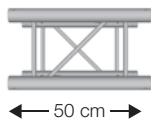
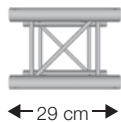

**QUA29-029**  
Square aluminium truss - 290 mm  
Length 29 cm

---

Code : H10118

---

**QUA29-050**  
Square aluminium truss - 290 mm  
Length 50 cm

---

Code : H10049

---

**QUA29-071**  
Quatro aluminium truss - 290 mm  
Length 71 cm

---

Code : H10593

---

**QUA29-100**  
Square aluminium truss - 290 mm  
Length 100 cm

---

Code : H10050

---

**QUA29-200**  
Square aluminium truss - 290 mm  
Length 200 cm

---

Code : H10051

---

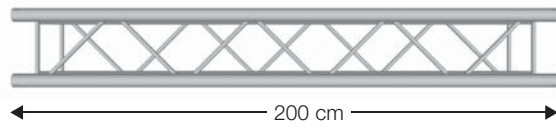

**QUA29-300**  
Square aluminium truss - 290 mm  
Length 300 cm

---

Code : H10052

---

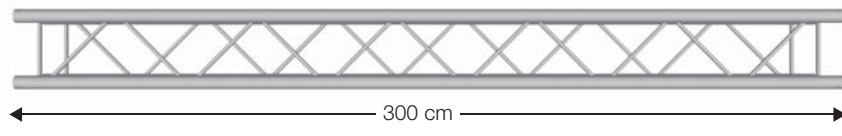

**The CONTEST® truss comes with :**

- 1 connection kit per bar

LENGTH (M)	↔	4	6	8	10	12	14	16
Max centred load (kg)	▼	1177	776.8	574.2	450.8	366.9	305.6	258.5
Deformation (mm)	⤵	12.3	27.9	49.8	78.4	113.8	156.4	206.6
Max distributed load (kg/m)	▼▼▼	449.5	258.9	143.6	90.2	61.2	43.7	32.3
Deformation (mm)	⤵	11.8	34.7	61.7	96.6	139.5	190.4	249.5

The load tables show the weight limits supported between two fixed hook points.  
Centred or distributed loads cannot be added together. Consult a qualified technician.



Manufacture according to DIN ISO 4113 and TÜV standards.  
Aluminium alloy truss (EN AW 6082 T6) 50 mm in diameter and 2 mm thick

**50 mm tubes**  
**16 mm braces**  
**Square section with 240 mm spacing between each tube (290 mm exterior)**

**Assembly with conical coupler, spigot pin and Safety R-springs**  
**Section: 290 mm**

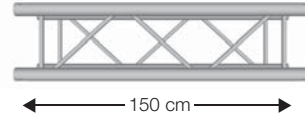
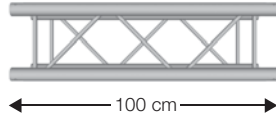
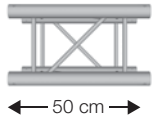

**BT-TRUSS QUAT 29050**

Square aluminium truss - 290 mm  
Length 50 cm

Code : B03650



**BT-TRUSS QUAT 29100**

Square aluminium truss - 290 mm  
Length 100 cm

Code : B03651



**BT-TRUSS QUAT 29150**

Square aluminium truss - 290 mm  
Length 150 cm

Code : B03654



**BT-TRUSS QUAT 29200**

Square aluminium truss - 290 mm  
Length 200 cm

Code : B03652

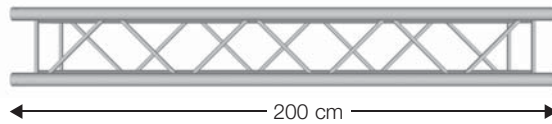

**BT-TRUSS QUAT 29250**

Square aluminium truss - 290 mm  
Length 250 cm

Code : B03657

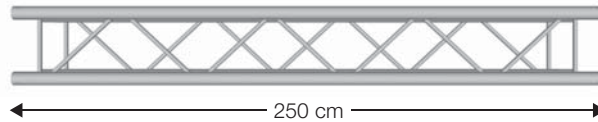

**BT-TRUSS QUAT 29300**

Square aluminium truss - 290 mm  
Length 300 cm

Code : B03653

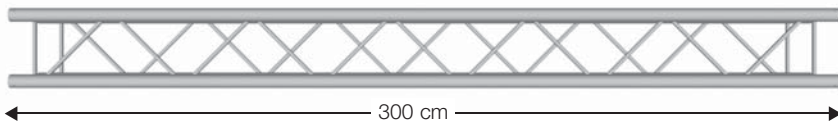

**The BRITEQ® truss is delivered WITHOUT the connection kit**

LENGTH (M)	↔	4	6	8	10	12	14	16
Max centred load (kg)	▼	1177	776.8	574.2	450.8	366.9	305.6	258.5
Deformation (mm)	⌒	12.3	27.9	49.8	78.4	113.8	156.4	206.6
Max distributed load (kg/m)	▼▼▼	449.5	258.9	143.6	90.2	61.2	43.7	32.3
Deformation (mm)	⌒	11.8	34.7	61.7	96.6	139.5	190.4	249.5

The load tables show the weight limits supported between two fixed hook points.  
Centred or distributed loads cannot be added together. Consult a qualified technician.



# QUATRO 290 TRUSS

- The CONTEST® truss comes with :
- 1 x connection kit, angle - 2 directions
  - 2 x connection kits, angle - 3, 4 and 5 directions

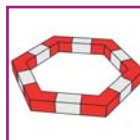
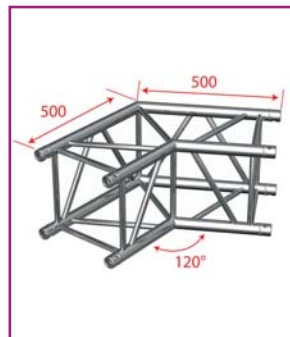
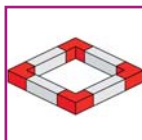
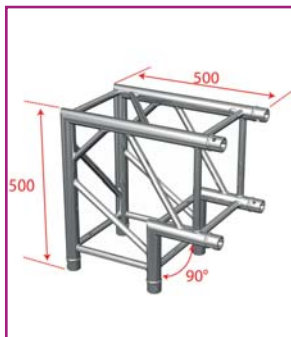
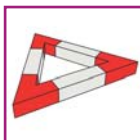
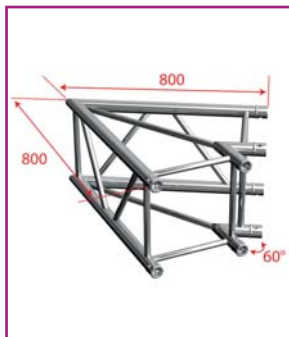

## AGQUA-01

Quatro angle - 80 cm 60° - 2 directions

Code : H10053



## AGQUA-02

Quatro angle - 50 cm 90° - 2 directions

Code : H10054



## AGQUA-03

Quatro angle - 50 cm 120° - 2 directions

Code : H10055

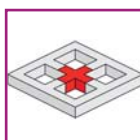
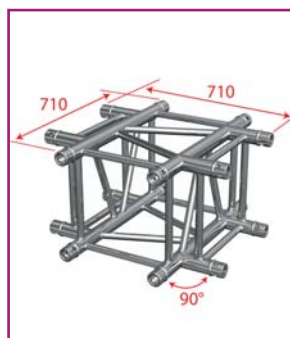
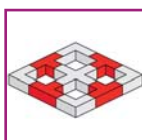
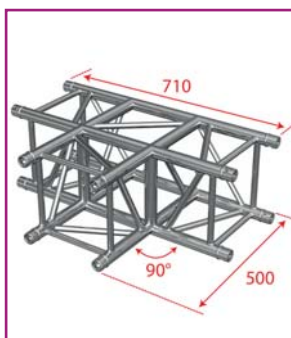
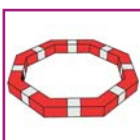

## AGQUA-04

Quatro angle - 50 cm 135° - 2 directions

Code : H10056



## AGQUA-05

Quatro angle - 90° - 3 directions

Code : H10057



## AGQUA-06

Quatro angle - 90° - 4 directions

Code : H10058

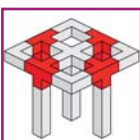
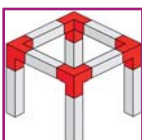
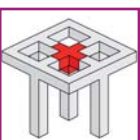

## AGQUA-07

Quatro angle - 90° - 5 directions

Code : H10059



## AGQUA-09

Quatro side piece - 3 directions

Code : H10061



## AGQUA-10

Quatro side piece - 4 directions

Code : H10062





The BRITeQ® truss is delivered WITHOUT the connection kit

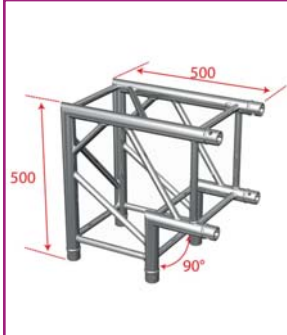

**BT-TRUSS QUAT 29 - A003**  
Quatro angle - 90° - 2 directions

Code : B03660

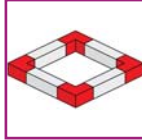

**BT-TRUSS QUAT 29 - A017**  
Quatro angle - 90° - 3 directions

Code : B03666

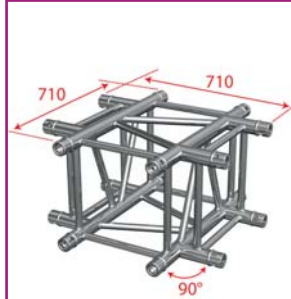
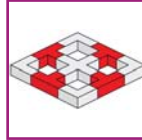

**BT-TRUSS QUAT 29 - A016**  
Quatro angle - 90° - 4 directions

Code : B03667

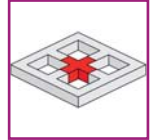

**BT-TRUSS QUAT 29 - A012**  
Quatro side piece - 3 directions

Code : B03665

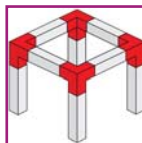

**BT-TRUSS QUAT 29 - A020**  
Quatro side piece - 4 directions

Code : B03668

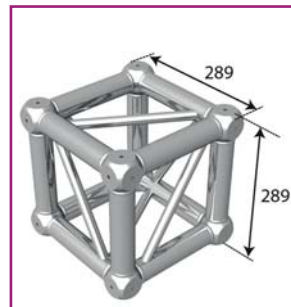
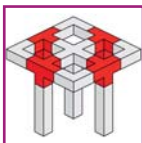

**AGCUB290**  
Connection cube for 290 mm square truss

Code : H10433

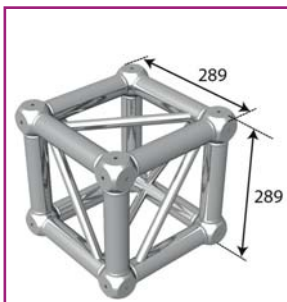

**BT-TRUSS QUAT 29 - BOX CORNER**  
Connection cube for 290 mm square truss

Code : B03670



**BT-TRUSS QUAT 29 - BOX Coupler Set (4 pcs)**  
4 sets of couplers for BT-TRUSS QUAT 29 - BOX CORNER.

Code : B03671



# QUATRO 290 TRUSS



Manufacture according to DIN ISO 4113 and TÜV standards.  
Aluminium alloy truss (EN AW 6082 T6) 50 mm in diameter and 2 mm thick

**Attention: we provide the circles on demand. 60 days lead time.**



## BT-TRUSS QUAT 29 - CIRCLE 2M

Quatro 290 truss, circle D=2m, 2 parts

Code : B03690



## BT-TRUSS QUAT 29 - CIRCLE 3M

Quatro 290 truss, circle D=3m, 2 parts

Code : B03691



## BT-TRUSS QUAT 29 - CIRCLE 4M

Quatro 290 truss, circle D=4m, 4 parts

Code : B03692



## BT-TRUSS QUAT 29 - CIRCLE 5M

Quatro 290 truss, circle D=5m, 4 parts

Code : B03693



## BT-TRUSS QUAT 29 - CIRCLE 6M

Quatro 290 truss, circle D=6m, 6 parts

Code : B03694



**The BRITEQ truss is delivered WITHOUT the connection set**





**BT-TRUSS 29-TROLLEY-BASE**  
Trolley + wheels for 290 mm truss

Code : B03495



**BT-TRUSS 29-TROLLEY-STACK**  
Stacking support for 290 mm

Code : B03496



**BT-TRUSS 29-TROLLEY-TOP**  
Trolley beams for 290 mm

Code : B03497



**EMQUA-B1**  
Quatro aluminium baseplate withcouplers, keys and pins. 290x290 mm

Code : H10064



**BT-TRUSS QUAT 29 - BASEPLATE**  
Quatro baseplate + half-couplers

Code : B03680



**BT-TRUSS Q/T 29 BASE80**  
41 Kg heavy baseplate for Trio/Quat 290 with half-couplers, 800 x 800 mm

Code : B03684



**EM29BLOU40D90**  
40 kg heavy baseplate for TRIO/QUATRO 290 of 90 cm diam

Code : H10835



**EM29BLOU29D74**  
40 kg heavy baseplate for TRIO/QUATRO 290 of 74 cm diam - 29kg

Code : H10463



**MCQUA-KIT**  
Set of 4 conical couplers, 8 spigot pins and 8 Safety R-springs

Code : H10063



**BT-TRUSS QUAT 29 - COUPLER SET**  
ALU TRUSS Quatro 290 coupler set (4pcs)

Code : B03681



**BT-TRUSS QUAT/TRIO 29 - SPIGOT + THREAD**  
Quatro/Trio 290 Spigot with thread (1pc)

Code : B03682



# QUATRO 220 TRUSS



Manufacture according to DIN ISO 4113 and TÜV standards.  
Aluminium alloy truss (EN AW 6082 T6) 50 mm in diameter and 2 mm thick

**35 mm tubes**  
**8 mm braces**  
**Square section with 185 mm spacing between each tube (220 mm exterior)**

**Assembly with conical coupler, spigot pin and Safety R-springs**  
**Section: 220 mm**



## DECO22Q-PT50

Square aluminium truss - 220 mm  
Length 50 cm

Code : H10218

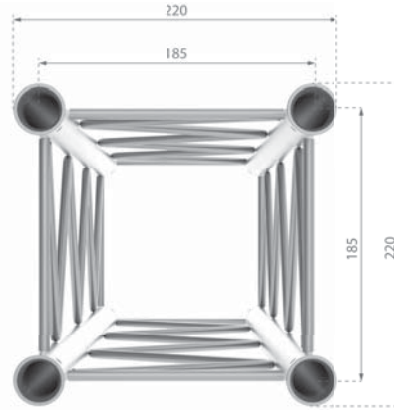
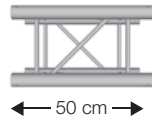

## DECO22Q-PT100

Square aluminium truss - 220 mm  
Length 100 cm

Code : H10219

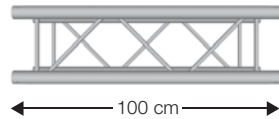

## DECO22Q-PT200

Square aluminium truss - 220 mm  
Length 200 cm

Code : H10220

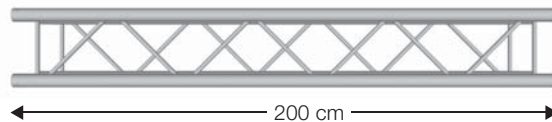

**The CONTEST® truss comes with :**  
• 1 coupler set per bar

LENGTH (M)		2	3	4	5	6
Max centred load (kg)		439.1	334.6	248.5	196.4	161.1
Deformation (mm)		1.9	4.9	8.7	13.7	19.8
Max distributed load (kg/m)		219.5	145.4	108.4	78.5	53.7
Deformation (mm)		1.2	4	9.5	16.9	24.4

The load tables show the weight limits supported between two fixed hook points.  
Centred or distributed loads cannot be added together. Consult a qualified technician.



Manufacture according to DIN ISO 4113 and TÜV standards.  
Aluminium alloy truss (EN AW 6082 T6) 50 mm in diameter and 2 mm thick

**35 mm tubes  
8 mm braces  
Square section with 185 mm spacing between each tube  
(220 mm exterior)**

**Assembly with conical coupler, spigot pin and Safety R-springs  
Section: 220 mm**

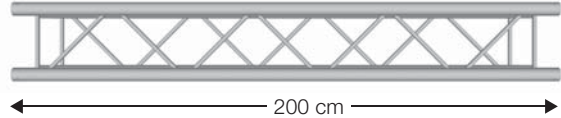
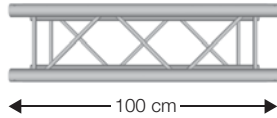
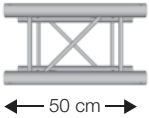

**BT-TRUSS QUAT 22050**

Square aluminium truss - 220 mm  
Length 50 cm

Code : B03550



**BT-TRUSS QUAT 22100**

Square aluminium truss - 220 mm  
Length 100 cm

Code : B03551



**BT-TRUSS QUAT 22200**

Square aluminium truss - 220 mm  
Length 200 cm

Code : B03552



**BT-TRUSS QUAT 22300**

Square aluminium truss - 220 mm  
Length 300 cm

Code : B03553

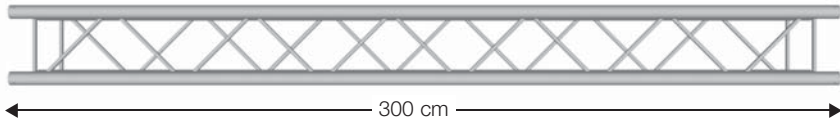

ALU TRUSS Quatro 220 L= 3,00M

**The BRITEQ® truss is delivered WITHOUT the connection kit**

LENGTH (M)		2	3	4	5	6
Max centred load (kg)		439.1	334.6	248.5	196.4	161.1
Deformation (mm)		1.9	4.9	8.7	13.7	19.8
Max distributed load (kg/m)		219.5	145.4	108.4	78.5	53.7
Deformation (mm)		1.2	4	9.5	16.9	24.4

The load tables show the weight limits supported between two fixed hook points.  
Centred or distributed loads cannot be added together. Consult a qualified technician.





# QUATRO 220 TRUSS

The CONTEST® truss comes with :

- 1 x connection kit, angle – 2 directions
- 2 x connection kits - 3, 4 directions

The BRITEQ® truss is delivered WITHOUT the connection kit

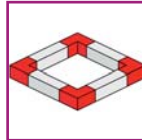

## DEC022Q-AG01

Quatro 220 angle - 50 cm 90° - 2 directions

Code : H10221

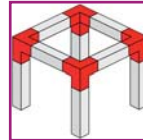

## DEC022Q-AG02

Quatro 220 side piece - 50 cm 90° - 3 directions

Code : H10222

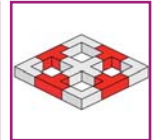

## DEC022Q-AG03

Quatro 220 angle - 90° - 3 directions

Code : H10223

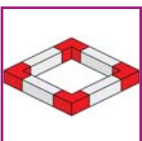

## BT-TRUSS QUAT 22 - A003

Quatro 220 angle - 50 cm 90° - 2 directions  
50 cm 90°

Code : B03560

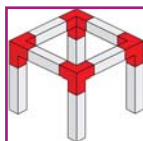
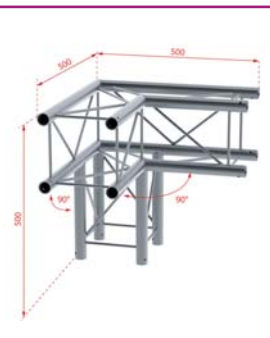

## BT-TRUSS QUAT 22 - A012

Quatro 220 side piece - 50 cm 90° - 3 directions

Code : B03565

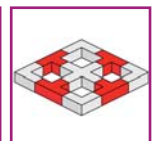
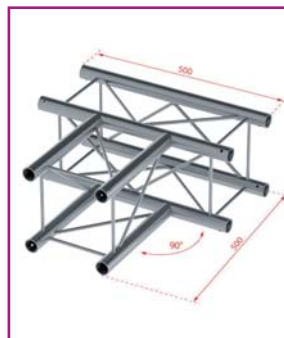

## BT-TRUSS QUAT 22 - A017

Quatro 220 angle - 90° - 3 directions

Code : B03566



## BT-TRUSS QUAT 22 - A016

Quatro 220 cross piece - 4 directions

Code : B03567



## BT-TRUSS QUAT 22 - A020

Quatro side piece - 4 directions

Code : B03568





**DEC022Q-EM-B1**

Quatro 220 aluminium baseplate with coupler kit

Code : H10225

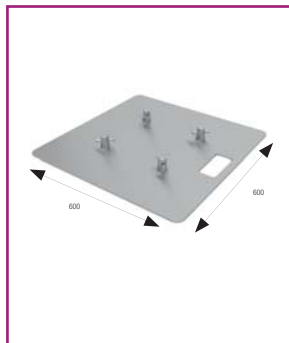

**DEC022-EMB-B3**

Aluminium baseplate 600x600 mm for DEC022T and DEC022Q with coupler kit

Code : H10606



**DEC022Q-MC-KIT**

Kit of 4 couplers, 8 spigot pins and 8 Safety R-springs

Code : H10224



**DEC022-MANCH**

Conical coupler for Deco series aluminium truss

Code : H10226



**DEC022-1/2MANCH**

1/2 conical coupler screw M8 for tube of 35

Code : H10332



**DEC022-CLAV**

Spigot pin for conical coupler DEC022 series by unit

Code : H10227



**DEC022-GOUP**

Safety R-spring for spigot pin for Deco series

Code : H10228



**BT-TRUSS QUAT 22 - COUPLER SET**

ALU TRUSS Quatro 220 Coupler Set (4pcs)

Code : B03581



# TRIO 290 TRUSS



Manufacture according to DIN ISO 4113 and TÜV standards.  
Aluminium alloy truss [EN AW 6082 T6] 50 mm in diameter and 2 mm thick.

**50 mm tubes**  
**16 mm braces**  
**Triangular section with 240 mm spacing between each tube (290 mm exterior)**

**Assembly with conical coupler, spigot pin and Safety R-springs**  
**Average weight per metre: 4.5 kg**  
**Section: 290 mm**

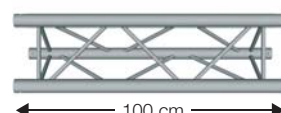
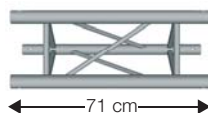
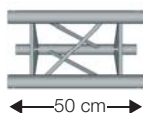

**PT29-029**  
Aluminium truss - 290 mm  
Length 29 cm

---

Code : H4213

---

**PT29-050**  
Aluminium truss - 290 mm  
Length 50 cm

---

Code : H3247

---

**PT29-071**  
Trio aluminium truss - 290 mm  
Length 71 cm

---

Code : H10592

---

**PT29-100**  
Aluminium truss - 290 mm  
Length 100 cm

---

Code : H3248

---

**PT29-200**  
Aluminium truss - 290 mm  
Length 200 cm

---

Code : H3249

---

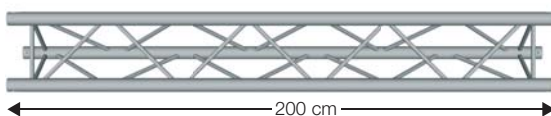

**PT29-300**  
Aluminium truss - 290 mm  
Length 300 cm

---

Code : H3250

---

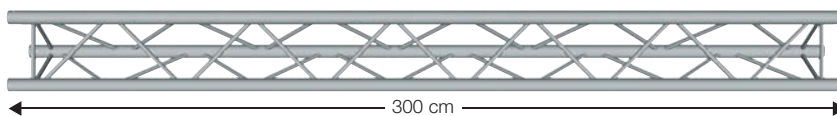

**The CONTEST® truss comes with :**  
• 1 connection kit per bar

LENGTH (M)		2	4	6	8	10	12
Max centred load (kg)		1023.9	506.4	331.5	242.2	187.2	149.2
Deformation (mm)		2.6	10.6	24	43.1	68.2	99.6
Max distributed load (kg/m)		783.1	253.2	110.5	60.6	37.4	24.9
Deformation (mm)		2.5	13.2	29.8	53	83.2	120.3

The load tables show the weight limits supported between two fixed hook points.  
Centred or distributed loads cannot be added together. Consult a qualified technician.

**50 mm tubes**  
**16 mm braces**  
**Triangular section with**  
**240 mm spacing between each**  
**tube (290 mm exterior)**

**Assembly with conical coupler,**  
**spigot pin and Safety R-springs**  
**Average weight per metre:**  
**4.5 kg**  
**Section: 290 mm**



Manufacture according to DIN ISO 4113 and TÜV standards.  
 Aluminium alloy truss (EN AW 6082 T6) 50 mm in diameter and 2 mm thick.

**BT-TRUSS TRIO 29050**

Aluminium truss - 290 mm  
 Length 50 cm

Code : B03600

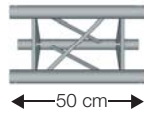

**BT-TRUSS TRIO 29100**

Aluminium truss - 290 mm  
 Length 100 cm

Code : B03601

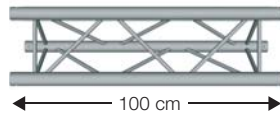

**BT-TRUSS TRIO 29200**

Aluminium truss - 290 mm  
 Length 200 cm

Code : B03602

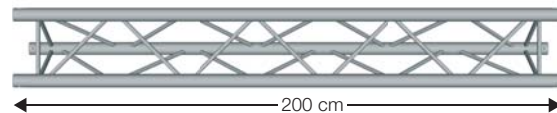

**The BRITEQ® truss is delivered WITHOUT the connection kit**

**BT-TRUSS TRIO 29300**

Aluminium truss - 290 mm  
 Length 300 cm

Code : B03603

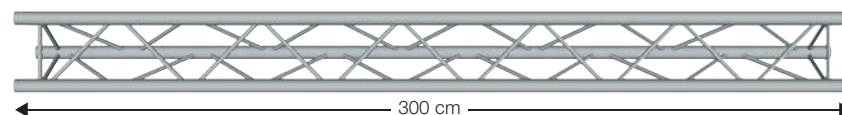

LENGTH (M)		2	4	6	8	10	12
Max centred load (kg)		1023.9	506.4	331.5	242.2	187.2	149.2
Deformation (mm)		2.6	10.6	24	43.1	68.2	99.6
Max distributed load (kg/m)		783.1	253.2	110.5	60.6	37.4	24.9
Deformation (mm)		2.5	13.2	29.8	53	83.2	120.3

The load tables show the weight limits supported between two fixed hook points.  
 Centred or distributed loads cannot be added together. Consult a qualified technician.



# TRIO 290 TRUSS

- The CONTEST® truss comes with :
- 1 x connection kit, angle – 2 directions
  - 2 x connection kits, angle – 3, 4 and 5 directions

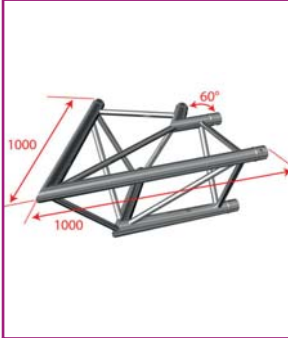

**AG29-020**

Angle - 290 mm 60° - 2 directions -

Code : H7015



**AG29-021**

Angle - 290 mm 90° - 2 directions -

Code : H3251

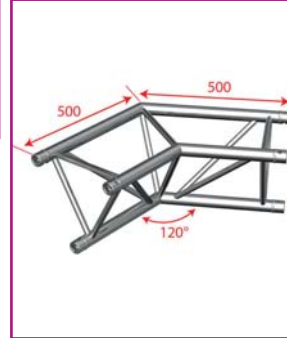
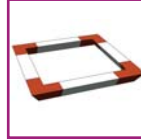

**AG29-022**

Angle - 290 mm 120° - 2 directions -

Code : H7016

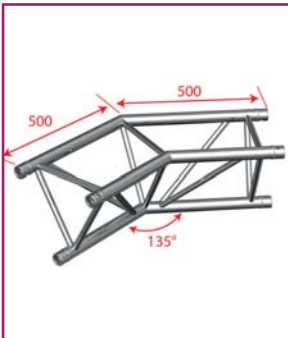
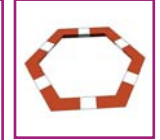

**AG29-023**

Angle - 290 mm 135° - 2 directions -

Code : H3252

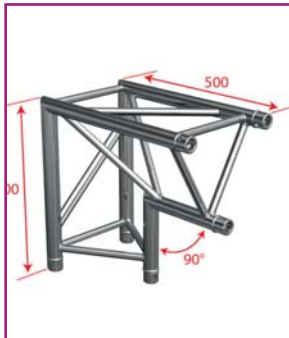

**AG29-025**

Angle - 290 mm 90° - 2 directions -  
Inner vertex

Code : H3253

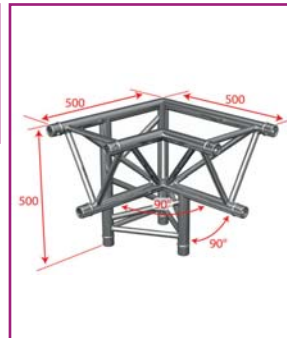

**AG29-033**

Angle - 290 mm 90° - 3 directions - Lower  
upright vertex

Code : H3254



**AG29-034**

Angle - 290 mm 90° - 3 directions -  
Lower left-hand vertex

Code : H3255



**AG29-035**

Vertical tee - 290 mm - 3 directions - Lower  
vertex

Code : H3256

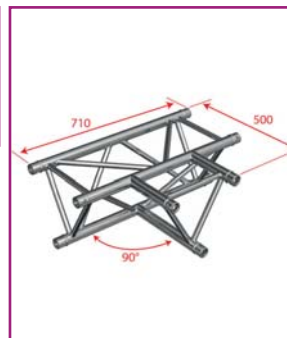

**AG29-036**

Horizontal tee - 290 mm 90° - 3 directions

Code : H3257





The BRITEQ® truss is delivered WITHOUT the connection kit

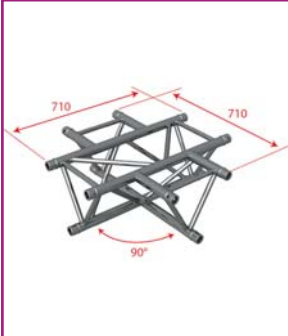

**AG29-041**  
 Cross - 290 mm - 4 directions

---

Code : H3258

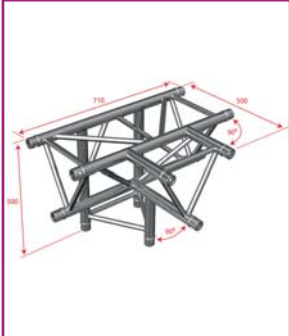

**AG29-042**  
 Tee - 290 mm - 4 directions - Apex down

---

Code : H3259

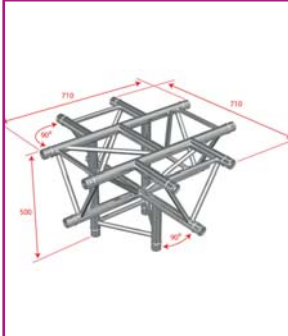

**AG29-053**  
 Cross - 290 mm - 4 directions plus base

---

Code : H4212



**BT-TRUSS TRIO 29 - A003**  
 Angle - 290 mm 90° - 2 directions -

---

Code : B03610



**BT-TRUSS TRIO 29 - A007**  
 Angle - 290 mm 90° - 2 directions - Apex down

---

Code : B03611



**BT-TRUSS TRIO 29 - A013**  
 Angle - 290 mm 90° - 3 directions - Apex down, right

---

Code : B03616



**BT-TRUSS TRIO 29 - A012**  
 Angle - 290 mm 90° - 3 directions - Apex down, left

---

Code : B03615



**BT-TRUSS TRIO 29 - A018**  
 Vertical tee - 290 mm - 3 directions Apex down

---

Code : B03618

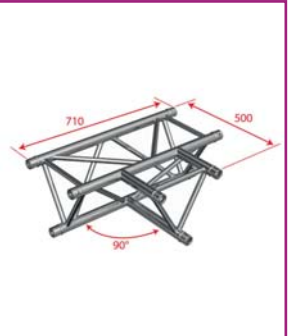

**BT-TRUSS TRIO 29 - A017**  
 Horizontal tee - 290 mm 90° - 3 directions

---

Code : B03617



# TRIO 290 TRUSS

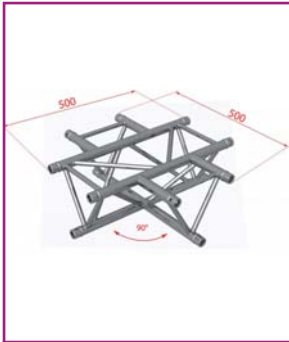

## BT-TRUSS TRIO 29 - A016

Cross - 290 mm - 4 directions

Code : B03619

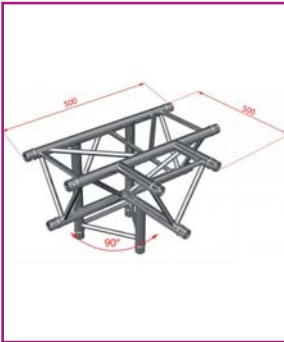
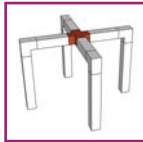

## BT-TRUSS TRIO 29 - A020

Tee - 290 mm - 4 directions - Apex down

Code : B03620

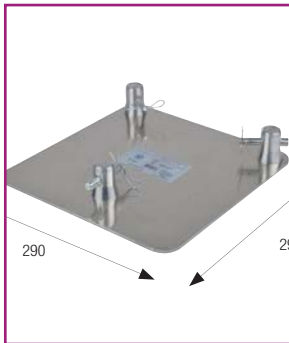

## EM29-B3

Triangular truss baseplate - 290 mm with conical couplers, spigot pins and Safety R-springs

Code : H8884



## EM29-B3T

Light triangular baseplate for PT29

Code : H10833



## MC29-KIT

Set of 3 conical couplers, 6 spigot pins and 6 Safety R-springs

Code : H3261

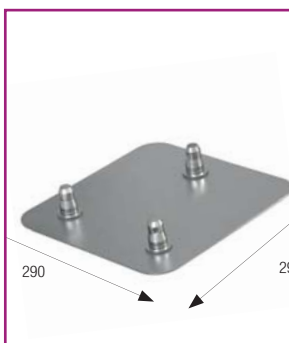

## BT-TRUSS TRIO 29 - BASEPLATE

290 mm baseplate with half-couplers

Code : B03630



## BT-TRUSS TRIO 29 - COUPLER SET

Set of 3 conical couplers, 6 spigot pins and 6 Safety R-springs

Code : B03631



## EM29BLOU29D74

40 kg heavy baseplate for TRIO/QUATRO 290 of 74 cm diam - 29kg

Code : H10835



## EM29BLOU29D74

40 kg heavy baseplate for TRIO/QUATRO 290 of 74 cm diam - 29kg

Code : H10463





**BT-TRUSS TRIO 29 - CIRCLE 2M**

Trio 290, circle D=2m, apex up, 2 parts

Code : B03640



**BT-TRUSS TRIO 29 - CIRCLE 3M**

Trio 290, circle D=3m, apex up, 2 parts

Code : B03641



**BT-TRUSS TRIO 29 - CIRCLE 4M**

Trio 290, circle D=4m, apex up, 4 parts

Code : B03642



**BT-TRUSS TRIO 29 - CIRCLE 5M**

Trio 290, circle D=5m, apex up, 4 parts

Code : B03643



**BT-TRUSS TRIO 29 - CIRCLE 6M**

Trio 290, circle D=6m, apex up, 6 parts

Code : B03644



Manufacture according to DIN ISO 4113 and TÜV standards. Aluminium alloy truss (EN AW 6082 T6) 50 mm in diameter and 2 mm thick.

**Attention: we provide the circles on demand. 60 days lead time.**

**The BRITEQ® truss is delivered WITHOUT the connection kit**



# TRIO 220 TRUSS



Manufacture according to DIN ISO 4113 and TÜV standards.  
Aluminium alloy truss (EN AW 6082 T6)  
50 mm in diameter and 2 mm thick.

**35 mm tubes**  
**8 mm braces**  
**Triangular section with**  
**185 mm spacing between each**  
**tube (220 mm exterior)**

**Assembly with conical coupler,**  
**spigot pin and Safety R-springs**  
**Section: 220 mm**

## DEC022T-PT50

Triangular aluminium truss - 20 mm  
Length 50 cm

Code : H10229

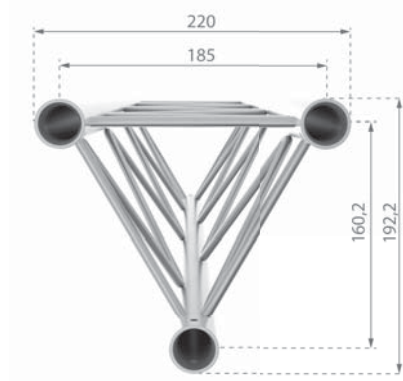
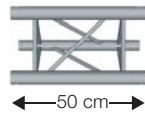

## DEC022T-PT100

Triangular aluminium truss - 220 mm  
Length 100 cm

Code : H10230

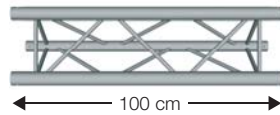

## DEC022T-PT200

Triangular aluminium truss - 220 mm  
Length 200 cm

Code : H10231

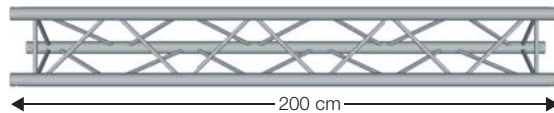

**The CONTEST® truss comes with :**

- 1 connection kit per bar
- 1 x connection kit, angle - 2 directions
- 2 x connection kits, angle - 3 and 4 directions

LENGTH (M)		2	3	4	5	6
Max centred load (kg)		217.7	143.2	105.4	82.3	66.4
Deformation (mm)		1.9	4.2	7.5	11.9	17.3
Max distributed load (kg/m)		190.2	95.5	52.7	32.9	22.1
Deformation (mm)		2	5.2	9.3	14.6	21.1

The load tables show the weight limits supported between two fixed hook points.  
Centred or distributed loads cannot be added together. Consult a qualified technician.

**35 mm tubes**  
**8 mm braces**  
**Triangular section with**  
**185 mm spacing between each**  
**tube (220 mm exterior)**

**Assembly with conical coupler,**  
**spigot pin and Safety R-springs**  
**Section: 220 mm**

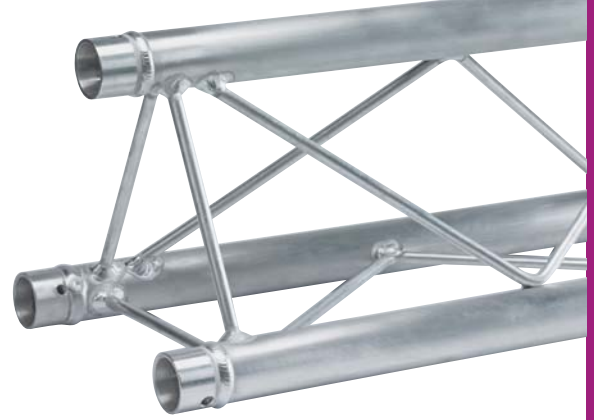

**BT-TRUSS TRIO 22050**

Triangular aluminium truss - 220 mm  
 Length 50 cm

Code : B03500

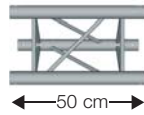

Manufacture according to DIN ISO 4113 and TÜV standards.

Aluminium alloy truss (EN AW 6082 T6) 50 mm in diameter and 2 mm thick.

**BT-TRUSS TRIO 22100**

Triangular aluminium truss - 220 mm  
 Length 100 cm

Code : B03501

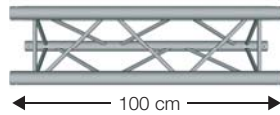

**The BRITEQ® truss is delivered WITHOUT the connection kit**

**BT-TRUSS TRIO 22200**

Triangular aluminium truss - 220 mm  
 Length 200 cm

Code : B03502

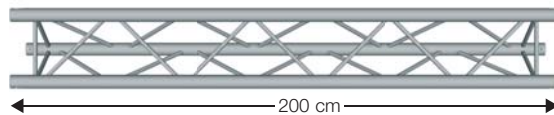

**BT-TRUSS TRIO 22300**

Triangular aluminium truss - 220 mm  
 Length 300 cm

Code : B03503

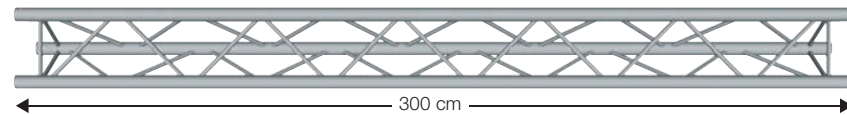

LENGTH (M)		2	3	4	5	6
Max centred load (kg)		217.7	143.2	105.4	82.3	66.4
Deformation (mm)		1.9	4.2	7.5	11.9	17.3
Max distributed load (kg/m)		190.2	95.5	52.7	32.9	22.1
Deformation (mm)		2	5.2	9.3	14.6	21.1

The load tables show the weight limits supported between two fixed hook points. Centred or distributed loads cannot be added together. Consult a qualified technician.





# TRIO 220 TRUSS

- The CONTEST® truss comes with :
- 1 x connection kit, angle – 2 directions
  - 2 x connection kits - 3, 4 directions



## DEC022T-AG01

Triangular angle 220  
2 directions - 50 cm 90°

Code : H10232

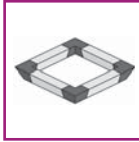

## DEC022T-AG02

Triangular angle 220  
3 directions - 50 cm 90° - upright

Code : H10233

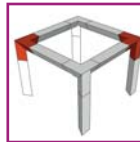

## DEC022T-AG03

Triangular angle 220  
3 directions - 50 cm 90° - left-hand

Code : H10234



## DEC022T-AG04

Triangular angle 220  
3 directions - 90° - flat

Code : H10235

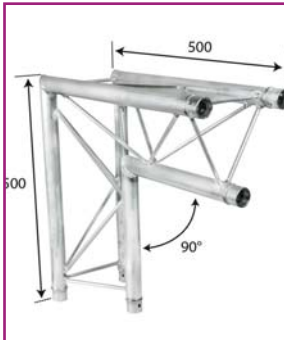

## DEC022T-AG05

Triangular angle 220  
2 directions - 50 cm 90° - right

Code : H10331

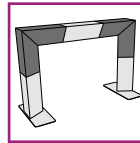

## BT-TRUSS TRIO 22 - A003

Triangular angle 220  
2 directions - 50 cm 90°

Code : B03510

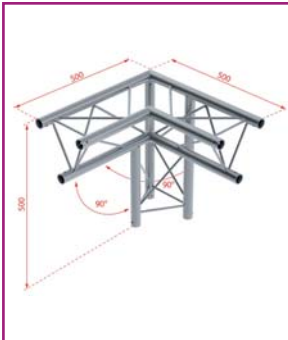
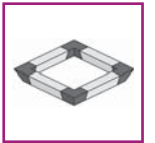

## BT-TRUSS TRIO 22 - A012

Triangular angle 220  
3 directions - 50 cm 90° - upright

Code : B03515



## BT-TRUSS TRIO 22 - A013

Triangular angle 220  
3 directions - 50 cm 90° - left-hand

Code : B03516

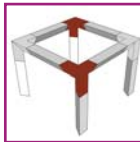

## BT-TRUSS TRIO 22 - A017

Triangular angle 220  
3 directions - 90° - flat

Code : B03517



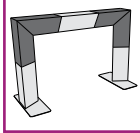

**BT-TRUSS TRIO 22 - A007**  
 Triangular angle 220  
 2 directions - 50 cm 90° - vertical

Code : B03511



**BT-TRUSS TRIO 22 - A016**  
 Triangular angle 220  
 4 directions

Code : B03519



**BT-TRUSS TRIO 22 - A018**  
 Triangular angle 220  
 3 directions

Code : B03518



**BT-TRUSS TRIO 22 - A020**  
 Triangular angle 220  
 4 directions

Code : B03520

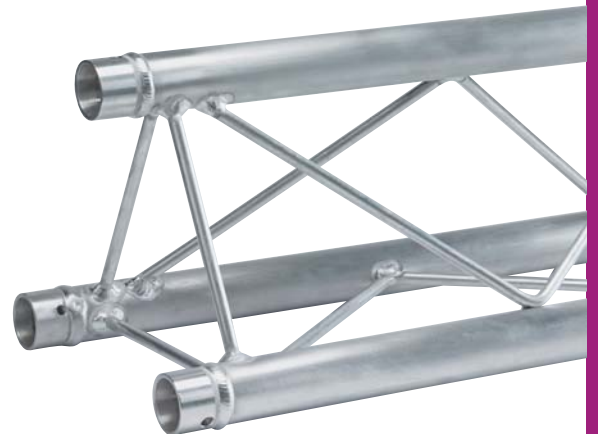

**The BRITEQ® truss is delivered WITHOUT the connection kit**



# TRIO 220 TRUSS

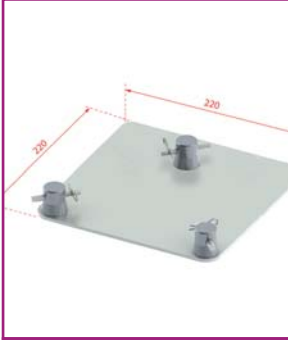

**DECO22T-EM-B1**  
Trio 220 baseplate with conical couplers, spigot pins and Safety R-springs

Code : H10237



**BT-TRUSS TRIO/  
QUAT 22 - BASEPLATE**  
Trio/Quatro 220 baseplate + half-couplers

Code : B03530



**DECO22-EMB2**  
Rectangular baseplate for Deco arch for tube of 35.620 x 240 mm

Code : H10333



**DECO22-MANCH**  
Conical coupler for Deco series aluminium truss

Code : H10226



**DECO22-1/2MANCH**  
1/2 conical coupler and M8 screw for tube of 35

Code : H10332



**DECO22-CLAV**  
Spigot pin for conical coupler DECO22 series by unit

Code : H10227



**DECO22-GOUP**  
Safety R-spring for spigot pin

Code : H10228



**DECO22T-MC-KIT**  
Set of 3 conical couplers, 6 spigot pins and 6 Safety R-springs

Code : H10236



**BT-TRUSS TRIO 22 -  
COUPLER SET**  
Set of 3 conical couplers, 6 spigot pins and 6 Safety R-springs

Code : B03531



# TRIO 200 TRUSS



The CONTEST® truss comes with :

- 1 connection kit per bar
- 1 x M8 fasteners kit for hanging projectors



**PT20-50**  
Metal truss - 200 mm  
Length 50 cm

---

Code : H10033

---

**PT20-75**  
Metal truss - 200 mm  
Length 75 cm

---

Code : H10034

---

**PT20-100**  
Metal truss - 200 mm  
Length 100 cm

---

Code : H10035

---

**PT20-150**  
Metal truss - 200 mm - 1.50 m length With  
5 hooks

---

Code : H8261

---

LENGTH IN (M)		1.5	3	4.5	6	7.5
Max centred load (kg)		100	80	59	45	30
Max distributed load (kg/m)		97	38	15	9	6

The load tables show the weight limits supported between two fixed hook points. Centred or distributed loads cannot be added together. Consult a qualified technician.



**AG20-021**  
Angle - 200 mm 90° - 2 directions -

Code : H8263

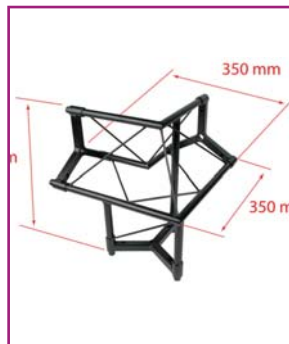

**AG20-033**  
Angle - 200 mm 90° - 3 directions -  
Lower upright vertex

Code : H8264



**AG20-034**  
Angle - 200 mm 90° - 3 directions  
Apex down, left

Code : H10584

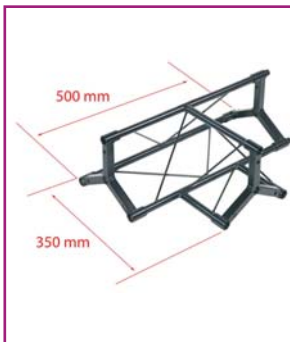

**AG20-035**  
Horizontal tee - 200 mm - 3 directions

Code : H8265



**AG20-036**  
Vertical tee - 200 mm - 3 directions -  
Apex down

Code : H8266



**EM20-BASE**  
Wall or floor baseplate For 200 mm steel  
truss

Code : H8267



# DUO 290 TRUSS



Manufacture according to DIN ISO 4113 and TÜV standards.  
Aluminium alloy truss (EN AW 6082 T6) 50 mm in diameter and 2 mm thick.

**50 mm tubes**  
**16 mm braces**  
**Ladder with 240 mm spacing between each tube (290 mm exterior)**

**Assembly with conical coupler, spigot pin and Safety R-spring**  
**Section: 290 mm**

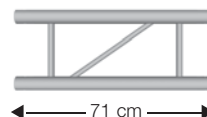
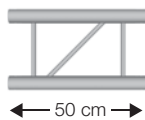
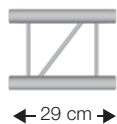

## DU029-029

290 mm aluminium ladder - Length 29 cm

Code : H10036



## DU029-050

290 mm aluminium ladder  
Length 50 cm

Code : H10037



## DU029-071

290 mm aluminium ladder  
Length 71 cm

Code : H10607



## DU029-100

290 mm aluminium ladder  
Length 100 cm

Code : H10038

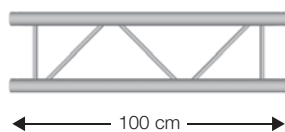

The CONTEST® truss comes with :  
• 1 connection kit per bar

The DU0290 Contest series and the BT-TRUSS DU0 Briteq series are not compatible with each other (trusses and angles)

## DU029-200

290 mm aluminium ladder  
Length 200 cm

Code : H10039

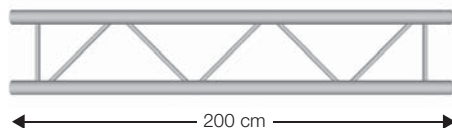

## DU029-300

290 mm aluminium ladder  
Length 300 cm

Code : H10040

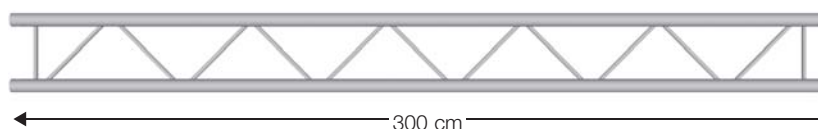

LENGTH (M)		2	3	4	5	6
Max centred load (kg)		904.3	787.9	589.1	469.4	389.2
Deformation (mm)		2.4	6.9	12.3	19.3	27.8
Max distributed load (kg/m)		452.2	300.7	225.0	179.6	129.7
Deformation (mm)		1.5	5.0	11.8	23.0	34.6

The load tables show the weight limits supported between two fixed hook points.

Centred or distributed loads cannot be added together. Consult a qualified technician.





Manufacture according to DIN ISO 4113 and TÜV standards.  
Aluminium alloy truss (EN AW 6082 T6) 50 mm in diameter and 2 mm thick.

**50 mm tubes**  
**16 mm braces**  
**Ladder with 240 mm spacing**  
**between each tube (290 mm exterior)**

**Assembly with conical coupler, spigot pin and Safety R-spring**  
**Section: 290 mm**

**BT-TRUSS DUO 29050**  
290 mm aluminium ladder  
Length 50 cm

---

Code : B03449

---

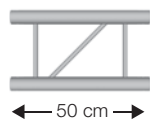

**BT-TRUSS DUO 29100**  
290 mm aluminium ladder  
Length 100 cm

---

Code : B03450

---

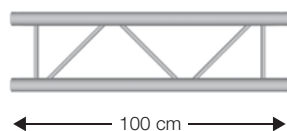

**BT-TRUSS DUO 29200**  
290 mm aluminium ladder  
Length 200 cm

---

Code : B03451

---

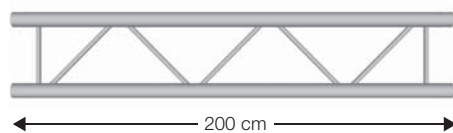

**BT-TRUSS DUO 29300**  
290 mm aluminium ladder  
Length 300 cm

---

Code : B03452

---

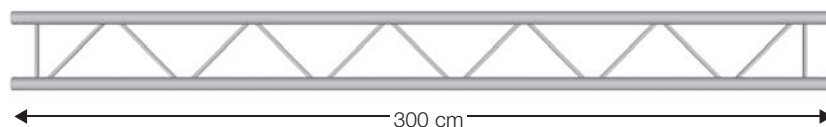

**The BRITEQ® truss is delivered WITHOUT the connection kit**  
**The DU0290 Contest series and the BT-TRUSS DUO Briteq series are not compatible (trusses and angles)**

LENGTH (M)		2	3	4	5	6
Max centred load (kg)		904.3	787.9	589.1	469.4	389.2
Deformation (mm)		2.4	6.9	12.3	19.3	27.8
Max distributed load (kg/m)		452.2	300.7	225.0	179.6	129.7
Deformation (mm)		1.5	5.0	11.8	23.0	34.6

The load tables show the weight limits supported between two fixed hook points.  
Centred or distributed loads cannot be added together. Consult a qualified technician.



# DUO 290 TRUSS

- The CONTEST® truss comes with :
- 1 x connection kit, angle - 2 directions
  - 2 x connection kits, angle - 2, 3, 4 directions

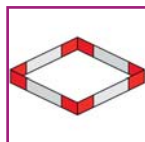

## AGDU029-01

Corner joint - 2 directions - 90° - upright

Code : H10041

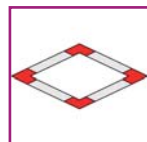
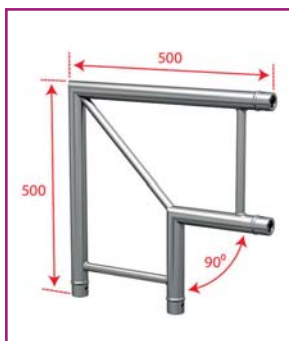

## AGDU029-02

Corner joint - 2 directions - 90° - flat

Code : H10042

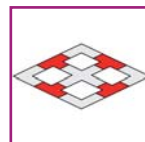
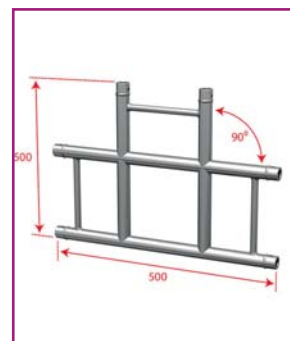

## AGDU029-03

Corner joint - 3 directions - 90° - flat

Code : H10043

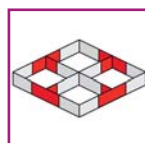

## AGDU029-04

Corner joint - 3 directions - 90° - upright

Code : H10044

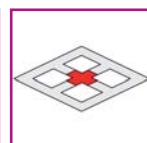
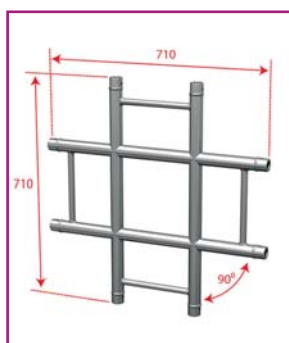

## AGDU029-05

Corner joint - 4 directions - 90° - flat

Code : H10045

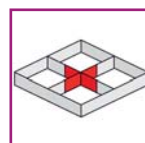
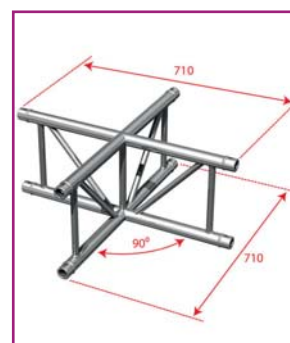

## AGDU029-06

Corner joint - 4 directions - 90° - upright

Code : H10046



## AGDU0-07

Corner joint - 3 directions - 45° - upright

Code : H10863



## AGDU0-08

Corner joint - 3 directions - 90° - upright

Code : H10864



## AGDU0-09

Corner joint - 3 directions - 45° - flat

Code : H10865



The BRITEQ® truss is delivered WITHOUT the connection kit

Attention: we provide the circles on demand. 60 days lead time.



**BT-TRUSS DUO 29-A007**

Aluminium ladder truss. Angle 90°.

Code : B03457



**BT-TRUSS DUO 29-A003**

Aluminium ladder truss. Angle 90°.

Code : B03456



**duo 290 circle 2m**

DUO 290 truss, circle D=2m, Horizontal

Code : B03463



**duo 290 circle 3m**

DUO 290 truss, circle D=3m, Horizontal

Code : B03462



**duo 290 circle 4m**

DUO 290 truss, circle D=4m, Horizontal

Code : B03461



**BT-TRUSS DUO 29**

DUO 290 truss, circle D=5m, Horizontal

Code : B03460



**EMDU0-B1**

DUO baseplate 290 mm with conical couplers, spigot pins and Safety R-springs

Code : H10048



**MCDU0-KIT**

With 2 conical couplers, 4 spigot pins and 4 Safety R-springs

Code : H10047



**SSL-Duo**

Support for DUO29 ladder on 35 mm base

Code : H10609



# UNO TRUSS

The CONTEST® truss comes with :

- 1x coupler per tube
- 2x coupler per angle



**UNO-50**  
Aluminium tube Diameter 50 mm  
length 50 cm

Code : H10238



**UNO-100**  
Aluminium tube Diameter 50 mm  
length 100 cm

Code : H10239



**UNO-150**  
Aluminium tube Diameter 50 mm  
length 150 cm

Code : H10240



**UNO-200**  
Aluminium tube Diameter 50 mm  
length 200 cm

Code : H10241



**UNO-50B**  
Aluminium tube Diameter 50 mm  
length 50 cm-Black

Code : H10417



**UNO-100B**  
Aluminium tube Diameter 50 mm  
length 100 cm-Black

Code : H10418



**UNO-150B**  
Aluminium tube Diameter 50 mm  
length 150 cm-Black

Code : H10419



**UNO-200B**  
Aluminium tube Diameter 50 mm  
length 200 cm-Black

Code : H10420





**BT-TRUSS Tube BLK 250**  
Extension for 'T' DROP ARM or 'H' FRAME.

Code : B03485



**BT-TRUSS Tube BLK 500**  
Extension for 'T' DROP ARM or 'H' FRAME.

Code : B03486



**BT-TRUSS Tube BLK 1000**  
Extension for 'T' DROP ARM or 'H' FRAME.

Code : B03487



**BT-TRUSS Tube BLK 2000**  
Extension for 'T' DROP ARM or 'H' FRAME.

Code : B03488



**UNO-AG01v2**  
Angle for tube Diameter 50 mm UNO + 2 x 1/2 coupler + spigot pin

Code : H10612



**UNO-1/2MANCH**  
Additional half coupler for angle UNO-AG01

Code : H10254



**UNO-T**  
Suspension T for hanging projectors 50 mm tube

Code : H10334



**UNO-H**  
H-Frame for hanging projectors 50 mm tube

Code : H10335



**UNO-A**  
Suspension bracket for projector for 50 mm tube. L 188 mm H 240 mm

Code : H10336

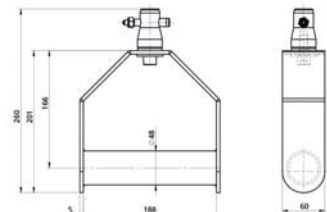
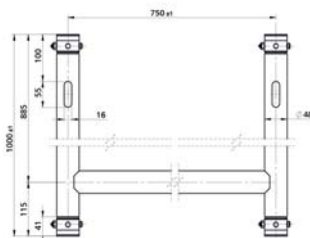
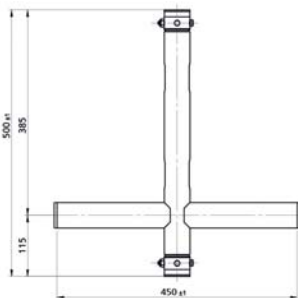



# UNO TRUSS



**BT-TRUSS T-Drop arm  
BLK 450x195**  
Suspension T for hanging projectors

Code : B03483



**BT-TRUSS T-Drop arm  
BLK 450x445**  
Suspension T for hanging projectors

Code : B03482



**BT-TRUSS T-Drop arm Thru  
BLK 450x500**  
Suspension T for hanging projectors

Code : B03484



**BT-TRUSS H-Frame  
BLK 750x1000**  
H-Frame to hang projectors

Code : B03481



**BT-TRUSS H-Frame  
BLK 750x415**  
H-Frame to hang projectors

Code : B03480



**BT-TRUSS Stirrup BLK**  
Projector suspension bracket for 50 mm tube.  
L 188 mm H 240 mm

Code : B03489

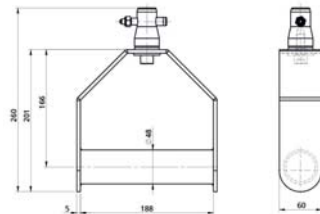
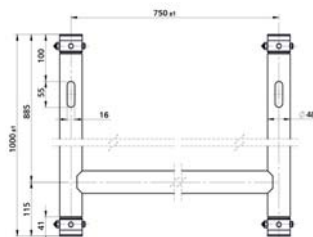
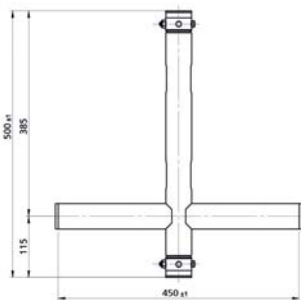

# DECO TRUSS



## DT10-150

DECO TRUSS, L=1.50m and couplers included

Code : B03033



## DT-10 BOX CORNER

DECO TRUSS, box corner (BOX KIT not included)

Code : B03040



## DT-10 BOX KIT

DECO TRUSS, set of 4 couplers for box corner

Code : B03041



## DT10-CLAMP

Clamp for 20 mm diameter tubes

Code : B03039

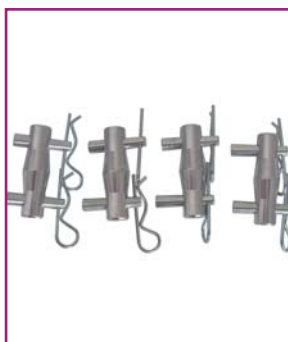

## DT10-COUPLER SET

DECO TRUSS, set of 4 couplers including spigot pins + security R-springs

Code : B03038



# TOTEMS



**TOTEM CONTEST® is delivered with:**

- 4x Tubes
- 2x Baseplates
- 2x Connection kits
- 1x Spandex textile



## TOT-100

Totem height 100 cm  
With baseplates and fabrics

Code : H10243



## TOT-150

Totem height 150 cm  
With baseplates and fabrics

Code : H10244



## TOT-200

Totem height 200 cm  
With baseplates and fabrics

Code : H10245



**TOTEM BRITEQ® is delivered with:**

- 4x Tubes
- 2x Baseplates
- 2x Connection kits
- 1x Spandex textile

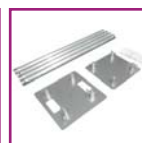

## BT-TRUSS STAND 100

Totem height 100 cm  
With baseplates and fabrics

Code : B03490



## BT-TRUSS STAND 150

Totem height 150 cm  
With baseplates and fabrics

Code : B03491



## BT-TRUSS STAND 200

Totem height 200 cm  
With baseplates and fabrics

Code : B03492





**BT-TRUSS STAND  
100 TUBES**  
Tubes for 100 cm TOTEM

Code : B03470



**BT-TRUSS STAND  
150 TUBES**  
Tubes for 150 cm TOTEM

Code : B03471



**BT-TRUSS STAND  
150 TUBES**  
Tubes for 200 cm TOTEM

Code : B03472



**TOT-BASEground**  
Floor baseplate for Totem with 4 half-couplers

Code : H10255



**TOT-BASEtop**  
Upper baseplate for Totem with 4 half-couplers

Code : H10256



**NEW**

**TOT-CIRCLE**  
Circle in tube of 50 of 96 cm diam. for Totem

Code : H10834



**BT-TRUSS STAND  
BASEPLATE ASSY**

Code : B03473



**TOT-CIRCLE is the only circle held in stock**



**TOT-Spandex1**  
Elastic fire-resistant textile for 1m Totem

Code : H10257



**TOT-Spandex1.5**  
Elastic fire-resistant textile for 1.5m Totem

Code : H10258



**TOT-Spandex2**  
Elastic fire-resistant textile for 2m Totem

Code : H10259



**TOT-Spandex1No**  
Elastic textile for 1m Totem - Black

Code : H10740



**TOT-Spandex1.5No**  
Elastic textile for 1.5m Totem - Black

Code : H10741



**TOT-Spandex2No**  
Elastic textile for 2m Totem - Black

Code : H10742



# HOOK ACCESSORIES



<b>A</b>	1/2MANCH Code : H6530	Conical half coupler Supplied with M12 x 12 screws, countersunk head		<b>B</b>	1/2MANCH-M10 Code : H10323	Conical half coupler with M10 screw for 50 mm tube	
<b>C</b>	CCT-20 Code : H7834	Professional clamp For 20 mm tube		<b>D</b>	CR20 Code : B02659	Professional clamp For 16-20 mm tube	
<b>E</b>	CR 30/LI Code : B02666	Clamp with protection plate.		<b>F</b>	CR30 Code : B02661	Professional clamp For 20-30 mm tube.	
<b>G</b>	CCT-50 Code : H3242	Professional clamp For 30 to 50 mm tube		<b>H</b>	CCT-50B Code : H10414	Professional clamp For 30 to 50 mm tube-Black	
<b>I</b>	CR50 Code : B02660	Professional clamp For 30-50 mm tube		<b>J</b>	CR50/LI Code : B02662	Clamp with protection plate.	
<b>K</b>	CCT-52 Code : H10330	Straight clamp with protection plate for 50 mm tube		<b>L</b>	CCT-55 Code : H7835	Clamp with protection plate For 30 to 50 mm tube	
<b>M</b>	CCT-55B Code : H10415	Clamp with protection plate for 30 to 50 mm tube-Black		<b>N</b>	CLAV Code : H6524	spigot pen for conical coupler / per piece	
<b>O</b>	CLAV/M8 Code : H7840	Key for conical coupler with M8 screw		<b>P</b>	CLP-250-B Code : H10348	Aluminium clamp for 50 mm tube - 250 kg load - Black	
<b>Q</b>	CLP-250-S Code : H10347	Aluminium clamp for tube 50 mm - 250 kg load - Silver		<b>R</b>	CLP-MANCH Code : H10832	CLP250S clamp + half coupler + M8 Spigot pen	
<b>S</b>	BT-TRUSS Code : B03479	Clamp with 1/2 coupler: BLACK ALU - SWL:100 kg		<b>T</b>	FAST CLAMP V2 Code : B02684	Quick fastening clamp for trusses with tubes from 48 to 51 mm diameter.	
<b>U</b>	ULTRA CLAMP Code : B06600	ULTRA CLAMP black Ultra fast clamp SWL 150kg tube 48-51mm		<b>V</b>	OMEGA BRACKET BIG Code : B02678	OMEGA clamp. Big version. Hole distance (centre to centre) : 141 mm.	
<b>W</b>	OMEGA BRACKET SMALL Code : B02677	OMEGA clamp. Small version. Hole distance (centre to centre) : 106 mm.		<b>X</b>	CLP-50-B Code : H10329	Aluminium clamp for 50 mm tube - 120 kg load - Black	
<b>Y</b>	CLP-50-S Code : H10328	Aluminium clamp for 50 mm tube - 120 kg load - Silver		<b>Z</b>	CLR-35 Code : H10324	Aluminium clamp for 35 mm tube - 50 kg load	
<b>A1</b>	CLR-70 Code : H10325	Double aluminium clamp for 35mm tube - 50 kg load		<b>B1</b>	CLR-100 Code : H10028	Double clamp For 50 mm tube	
<b>C1</b>	CLR-150 Code : H10326	Aluminium clamp for 50 mm tube - 100 kg load		<b>D1</b>	CLR-250 Code : H10327	Double aluminium clamp For 50 mm tube - 100 kg load	
<b>E1</b>	SWIVEL CLAMP 302-V2 Code : B02682	Double mounting clamp that can rotate 360°.		<b>F1</b>	SWIVEL CLAMP 502-V2 Code : B02683	Double mounting clamp that can rotate 360°	
<b>G1</b>	CLR-50 Code : H7836	Aluminium clamp For 50 mm tube		<b>H1</b>	CLR50B Code : H10416	Aluminium clamp For 50 mm tube-Black	
<b>I1</b>	ALU CLAMP 101-V2 Code : B02687	Fixing clamp for trusses with 48-51 mm diameter tubes.		<b>J1</b>	ALU CLAMP 301-V2 Code : B02680	Fixing clamp for heavy duty applications for tubes from 48 to 51 mm diameter.	





<b>K1</b>	ALU CLAMP 801-V2 Code : B02681	Fixing clamp for heavy duty applications for tubes up to 48 mm diameter 51 mm		<b>L1</b>	ELG0615 Code : H10459	Sheathed cable - 6 mm diameter and 150 cm length - MWL 400 kg	
<b>M1</b>	ELG0620 Code : H10460	Sheathed cable - 6 mm diameter and 200 cm length - MWL 400 kg		<b>N1</b>	ELG0815 Code : H10461	Sheathed cable - 8 mm diameter and 150 cm length - MWL 700 kg	
<b>O1</b>	ELG0820 Code : H10462	Sheathed cable - 8 mm diameter and 200 cm length - MWL 700 kg		<b>P1</b>	ELG1003 Code : H9971	3 mm steel wire. Length 100 cm, 1 quick-release clip	
<b>Q1</b>	ELG1015 Code : H10444	Sheathed cable - 10 mm diameter and 150 cm length - MWL 1000 kg		<b>R1</b>	ELG1020 Code : H10445	Sheathed cable - 10 mm diameter and 200 cm length - MWL 1000 kg	
<b>S1</b>	ELG301 Code : H9967	1 mm steel wire. L30 cm 1 quick-release clip		<b>T1</b>	ELG602 Code : H9969	2 mm steel wire. Length 60 cm, 1 quick-release clip	
<b>U1</b>	SAFETY CABLE Code : B02685	Safety cable, diameter 2 mm, Length 60 cm.		<b>V1</b>	SAFETY CABLE D4-60CM Code : B02686	4 mm steel wire. Length 60 cm.	
<b>X1</b>	EYE-10F Code : H10436	Female M10 eye bolt MWL 230 kg					
<b>A2</b>	GOUP Code : H6525	Security R-spring by unit		<b>B2</b>	HOOK-1000 Code : H10434	High resistance shackle MWL 1000 kg	
<b>C2</b>	MAIL-750 Code : H10435	Connection link for 750 kg MWL cable		<b>D2</b>	MANCH Code : H6523	Conical coupler by unit	
<b>E2</b>	PAT-50 Code : H7838	Fixing plate For 50 mm tube		<b>F2</b>	SAN-00 Code : H10441	Ratchet strap and 5m 2000 kg MWL hook	
<b>G2</b>	SAN-01 Code : H10030	Safety strap 2000Kg MWL		<b>H2</b>	SAN-02 Code : H10031	Binding band 2000Kg MWL	
<b>I2</b>	SAN-03 Code : H10032	Strap - 4m length, 2000Kg MWL		<b>J2</b>	SAN-04 Code : H10437	Useful 1.5m tubular textile strap 1000 kg MWL	
<b>K2</b>	SAN-05 Code : H10438	Useful 2m tubular textile strap 1000 kg MWL		<b>L2</b>	SAN-06 Code : H10439	Useful 1.5m tubular core steel strap 1000 kg MWL	
<b>M2</b>	SAN-07 Code : H10440	Useful 2m tubular core steel strap 1000 kg MWL		<b>N2</b>	SHA-01 Code : H10029	Metal shackle - 2000 kg MWL	
<b>O2</b>	SPT290 Code : H10027	Suspension piece for 290 mm truss		<b>P2</b>	SST-35 Code : H3240	150 to 350 mm truss support for 35 mm base	
<b>Q2</b>	SST-20 Code : H8262	Fixing tee for PT20-150 truss on 28 mm base		<b>R2</b>	SST-22 Code : H10873	Fixing T for 220 Truss on 35mm base	
<b>S2</b>	SUP-PIL Code : H10608	Post support with clamping chain					



# WINCH STANDS



Self-locking gear winch, combined with quality components and workmanship for high stability.

Transport and installation are facilitated by three articulated legs.

Ergonomic clamping wheel to eliminate play in the mast.



**ELV-400PRO**  
Self-braking winch stand with 3 sections  
4 metres - 80 kg

---

Code : H9996

---



Material: Treated steel  
Electro-galvanized finish and black epoxy paint  
Top mast: Ø 35 mm  
Winch: Self-braking anti-return gear  
Cable: Galvanized steel, diameter 5 mm  
Max height: : 4,00 m  
Max load: : 80 kg  
Folded length: 1.59 m  
Weight: 23 kg  
TÜV approved



**LS-400**  
Self-braking winch stand - 4,00m / 80 kg

---

Code : B00748

---



Winch stand with automatic brake and lockable safety  
Max height: : 4,00 m  
Baseplate: 1.15-1.50m  
Section of the last mat: 35 mm  
Maximum load: 80 kg  
Folded length: 1.60 m  
Weight: 18 kg  
Made in France  
TÜV, GS approved



**ELV-270PRO**  
Self-braking winch stand with 2 sections  
2,7 metres - 60 kg

---

Code : H9995

---



Material: Treated steel  
Electro-galvanized finish and black epoxy paint  
Top mast: Ø 35 mm  
Winch: Self-braking anti-return gear  
Cable: Galvanized steel, diameter 3 mm  
Max height: : 2,70 m  
Max load: : 60 kg  
Folded length: 1.60 m  
Weight: 12 kg  
TÜV approved



**LS-290**  
Self-braking winch stand - 3,00m / 60 kg

---

Code : B00747

---



Winch stand with automatic brake and lockable safety  
Max height: : 3,00 m  
Baseplate: 1.20 m  
Section of the last mat: 35 mm  
Maximum load: 60 kg  
Folded length: 1.55 m  
Weight: 12 kg  
Made in France  
TÜV, GS approved





**LS-270**  
Economical self-braking 2,70m winch stand

---

Code : B00738

---



Winch stand with automatic brake and lockable safety  
Max height: : 2,70 m  
Section of the last mat: 35 mm  
Weight: 11 kg  
TÜV, GS approved



# FLOOR CABLE PROTECTORS

The range of Contest® floor cable protectors is designed to protect your cables during your events. Made of Polyurethane to withstand external aggressions, strong compressions and fire-resistant treatments. They are modular and adapt to the surface.

Easy to use and compact, they can be used temporarily or intensively. In addition, their covers are designed not to open unexpectedly and thus ensure to keep your cables safe.



## XC233

Cable protector with 2 3x3 cm channels and cover - 1m length

Code : H10426



## XC233AG

45° angle for XC233 cable protector

Code : H10427



## XC14

Cable protector with one single channel - 1m length

Code : H10425



## XC5-121

Flexible cable protector with 5 channels. 121mm - 9 m

Code : H10735



Materials: Rubber - polyurethane (base) polyurethane + PVC (cover)  
 Fire resistance: Class B1  
 Electrical safety: Directive 73/23/CE  
 Cable channels: 2  
 Cable channel: 30 mm  
 Static load: 2500 kg on a surface of 20 x 20 cm  
 Width: 250 mm  
 Length: 1000 mm  
 Height: 45 mm  
 Weight: 7.9 Kg

Materials: Rubber - polyurethane (base) polyurethane + PVC (cover)  
 Fire resistance: Class B1  
 Electrical safety: Directive 73/23/CE  
 Cable channels: 2  
 Cable channel: 30 mm  
 Static load: 2500 kg on a surface of 20 x 20 cm  
 Width: 250 mm  
 Length: 285 mm  
 Height: 45 mm  
 Weight: 3 Kg

Materials: Polyurethane  
 Fire resistance: Class B1  
 Electrical safety: Directive 73/23/CE  
 Cable channels: 1  
 Cable channel: 38 mm x 13 mm  
 Static load: 100 kg on a surface of 20 x 20 cm  
 Width: 135 mm  
 Length: 1000 mm  
 Height: 35 mm  
 Weight: 2 Kg

Materials: Injection moulded 80% virgin PVC - 20% NBR  
 Fire resistance: Class B1  
 Electrical safety: Directive 73/23/EC  
 Cable channels : 5  
 Cable channel: 16.7 x 15 mm  
 Static load: 200Kg  
 Width: 121 mm  
 Length: 9m  
 Height: 23 mm  
 Weight: 16.5 Kg



## XC5-64

Flexible cable protector with 5 channels. 64mm - 9 m length

Code : H10734



Materials: Injection moulded 80% virgin PVC - 20% NBR  
 Fire resistance: Class B1  
 Electrical safety: Directive 73/23/CE  
 Cable channels: 5  
 Cable channel: 14 x 9.7 mm  
 Static load: 200Kg  
 Width: 64 mm  
 Length: 9m  
 Height: 9 mm  
 Weight: 7.5 Kg



# PLATFORMS



## FIRE RESISTANCE

Fire resistance class: **Bfl-S1** (corresponds to the French class **M1**). It conforms to the **EN13501-1+A1:2010** European standard.

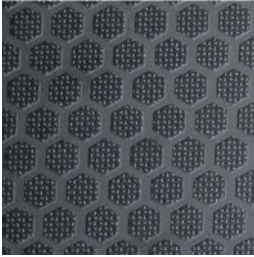

12mm black multi-ply anti-slip plywood

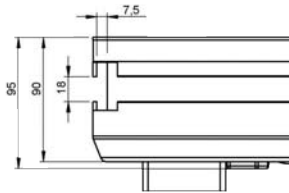

Internal structure of the multi-ply plywood platform and aluminium frame (EN AW6082T6)



## NEW PLATFORMS NEW UNIVERSAL ANGLES



**ROUND LEGS**  
48.3mm

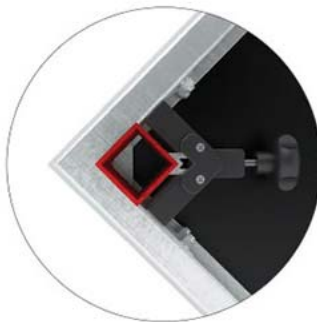

**SQUARE LEGS**  
50X50mm

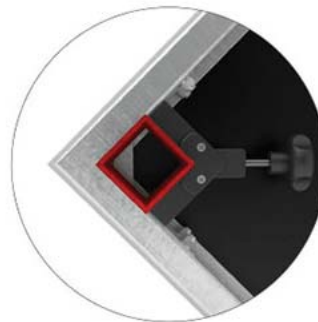

**SQUARE LEGS**  
60X60 mm



### PLTS-1x1

1m Platform x 1m non-slip 750 kg/m<sup>2</sup>- black - Delivered without legs

Code : H10370



Material:  
 - Frame: Aluminium  
 - Tray: 12mm multi-ply  
 Thickness: 90 mm  
 Allowable distributed load: 750 Kg/m<sup>2</sup>  
 Weight: 16 Kg



### PLTS-2x1

2m Platform x 1m non-slip 750 kg/m<sup>2</sup>- black - Delivered without legs

Code : H10369



Material:  
 - Frame: Aluminium  
 - Tray: 12mm multi-ply  
 Thickness: 90 mm  
 Allowable distributed load: 750 Kg/m<sup>2</sup>  
 Weight: 32 Kg



### PLTS-1x0.5

Platform 1x0.5m non-slip 750 kg/m<sup>2</sup>- black - Delivered without legs

Code : H10602



Material:  
 - Frame: Aluminium  
 - Tray: 12mm multi-ply  
 Thickness: 90 mm  
 Allowable distributed load: 750 Kg/m<sup>2</sup>  
 Weight: 8 Kg



### PLTS-2x0.5

Platform 2x0.5m non-slip 750 kg/m<sup>2</sup>- black - Delivered without legs

Code : H10601



Material:  
 - Frame: Aluminium  
 - Tray: 12mm multi-ply  
 Dimension : 2 m x 0.5 m  
 Thickness: 90 mm  
 Allowable distributed load: 750 Kg/m<sup>2</sup>  
 Weight: 16 Kg



### PLTS-T1x1

1x1m anti-slip triangular platform 750 kg/m<sup>2</sup>- black - Delivered without legs

Code : H10603



Material:  
 - Frame: Aluminium  
 - Tray: 12mm multi-ply  
 Dimension : 1 x 1 m  
 Thickness: 90 mm  
 Allowable distributed load: 750 Kg/m<sup>2</sup>  
 Weight: 8 Kg



### PLTS-c1

Platform assembly clamp

Code : H10371



Material: Steel  
 Thickness: 4 mm  
 Weight: 0.42 Kg



### PLT-j1

Junction insert

Code : H10372



Compatible with PLTL and PLTS series  
 Material: Steel  
 Thickness: 3 mm  
 Weight: 78 g



### PLT-j2

Leveling insert

Code : H10373



Compatible with PLTL and PLTS series  
 Material: ABS  
 Weight: 11 g





# PLATFORMS



## PLTS-ft4060

Telescopic square leg - 0.4 m to 0.6m - per unit

Code : H10374



Material: Aluminium  
Thickness: 2 mm  
Section: 60 x 60 mm  
Weight: 1.66 Kg



## PLTS-ft60100

Telescopic square leg - 0.6m to 1m - per unit

Code : H10375



Material: Aluminium  
Thickness: 2 mm  
Section: 60 x 60 mm  
Weight: 1.8 Kg



## PLTS-ft80140

Telescopic square leg - 0.8m to 1.4m - per unit

Code : H10403



Material: Aluminium  
Thickness: 2 mm  
Section: 60 x 60 mm  
Weight: 2.5 Kg



## PLTS-f20

Square leg 20 cm high - per unit

Code : H10376



Material: Aluminium  
Thickness: 2 mm  
Section: 60 x 60 mm  
Weight: 0.42 Kg



## PLTS-f40

Square leg 40 cm high - per unit

Code : H10377



Material: Aluminium  
Thickness: 2 mm  
Section: 60 x 60 mm  
Weight: 0.78 Kg



## PLTS-f60

Square leg 60 cm high - per unit

Code : H10378



Material: Aluminium  
Thickness: 2 mm  
Section: 60 x 60 mm  
Weight: 1.15 Kg



## PLTS-f80

Square leg 80 cm high - per unit

Code : H10379



Material: Aluminium  
Thickness: 2 mm  
Section: 60 x 60 mm  
Weight: 1.52 Kg



## PLTS-f100

Square leg 1 m high - per unit

Code : H10380



Material: Aluminium  
Thickness: 2 mm  
Section: 60 x 60 mm  
Weight: 1.89 Kg

**NEW**



**PLTS-FW24**

Square leg with caster - Height 24,5 cm

Code : H10858



Material: Aluminium  
Thickness: 3 mm  
Section: 60 x 60 mm  
Wheel diameter: 100 mm  
Weight: 1.41 Kg

**NEW**



**PLTS-FW40**

Square leg with caster - Height 40 cm

Code : H10859



Material: Aluminium  
Thickness: 3 mm  
Section: 60 x 60 mm  
Wheel diameter: 100 mm  
Weight: 1.69 Kg

**NEW**



**PLTS-FW60**

Square leg with caster - Height 60 cm

Code : H10860



Material: Aluminium  
Thickness: 3 mm  
Section: 60 x 60 mm  
Wheel diameter: 100 mm  
Weight: 2.06 Kg

**NEW**



**PLTS-FW80**

Square leg with caster - Height 80 cm

Code : H10861



Material: Aluminium  
Thickness: 3 mm  
Section: 60 x 60 mm  
Wheel diameter: 100 mm  
Weight: 2.43 Kg

**NEW**



**PLTS-FW100**

Square leg with caster - Height 100 cm

Code : H10862



Material: Aluminium  
Thickness: 3 mm  
Section: 60 x 60 mm  
Wheel diameter: 100 mm  
Weight: 2.80 Kg



**PLTS-fc2**

Connecting clamp for two square legs

Code : H10381



Material: Aluminium  
Thickness: 5 mm  
For section: 60 x 60 mm  
Weight: 0.48 Kg



**PLTS-fc4**

Connecting clamp for four square legs

Code : H10382



Material: Aluminium/Steel  
Thickness: 4,5 mm  
For section: 60 x 60 mm  
Weight: 0.48 Kg



# PLATFORMS



## PLTS-g1x1

Bar railing lg 1 m without fastener

Code : H10421



Material: Aluminium  
Diameter: 45.2 mm  
Weight: 7.9 Kg  
Length: 1 m  
Height: 1.2 m

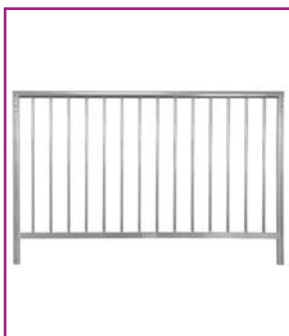

## PLTS-g2x1

Bar railing lg 2 m without fastener

Code : H10422



Material: Aluminium  
Diameter: 45.2 mm  
Weight: 12 Kg  
Length: 2 m  
Height: 1.2 m



## PLTS-gc1

Straight fastener for bar railing

Code : H10454



Straight fastener for guardrail:  
PLTS-g2x1  
PLTS-g1x1



## PLTS-gc2

Angled fastener for bar railing

Code : H10455



Angled fastener for guardrail:  
PLTS-g2x1  
PLTS-g1x1

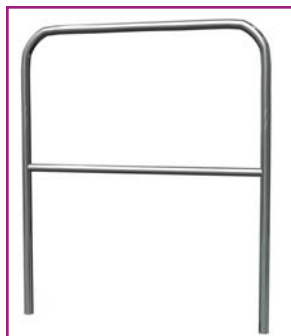

## PLTS-h1x1

Guardrail for platform of 1m length  
Supplied with fasteners

Code : H10392



Material: Aluminium  
Thickness: 2 mm  
Diameter: 35 mm  
Weight: 2.83 Kg  
Length: 1 m  
Height: 1.2 m



## PLTS-h2x1

Guardrail for platform of 2m length  
Supplied with fasteners

Code : H10391



## PLTS-hc1

Platform guardrail fastener - per unit

Code : H10393



Guardrail fastener:  
PLTS-h1x1  
PLTS-h2x1  
Material: Steel  
Thickness: 4 mm  
Weight: 0.45 Kg



## PLTS-hc2

STAGE series guardrail junction clamp

Code : H10394



Junction clamp for guardrail  
PLTS-h1x1  
PLTS-h2x1  
Material: Steel  
Thickness: 5.5 mm  
Weight: 1.14 Kg

## EXAMPLES OF CONFIGURATIONS WITH 4 PLTS PLATFORMS-2x1

NOTE: From a height of 1 metre and to maintain full stability of the assembly, it is advisable to install the connecting clamps for 2 legs (PLTS-fc2) and 4 legs (PLTS-fc4).

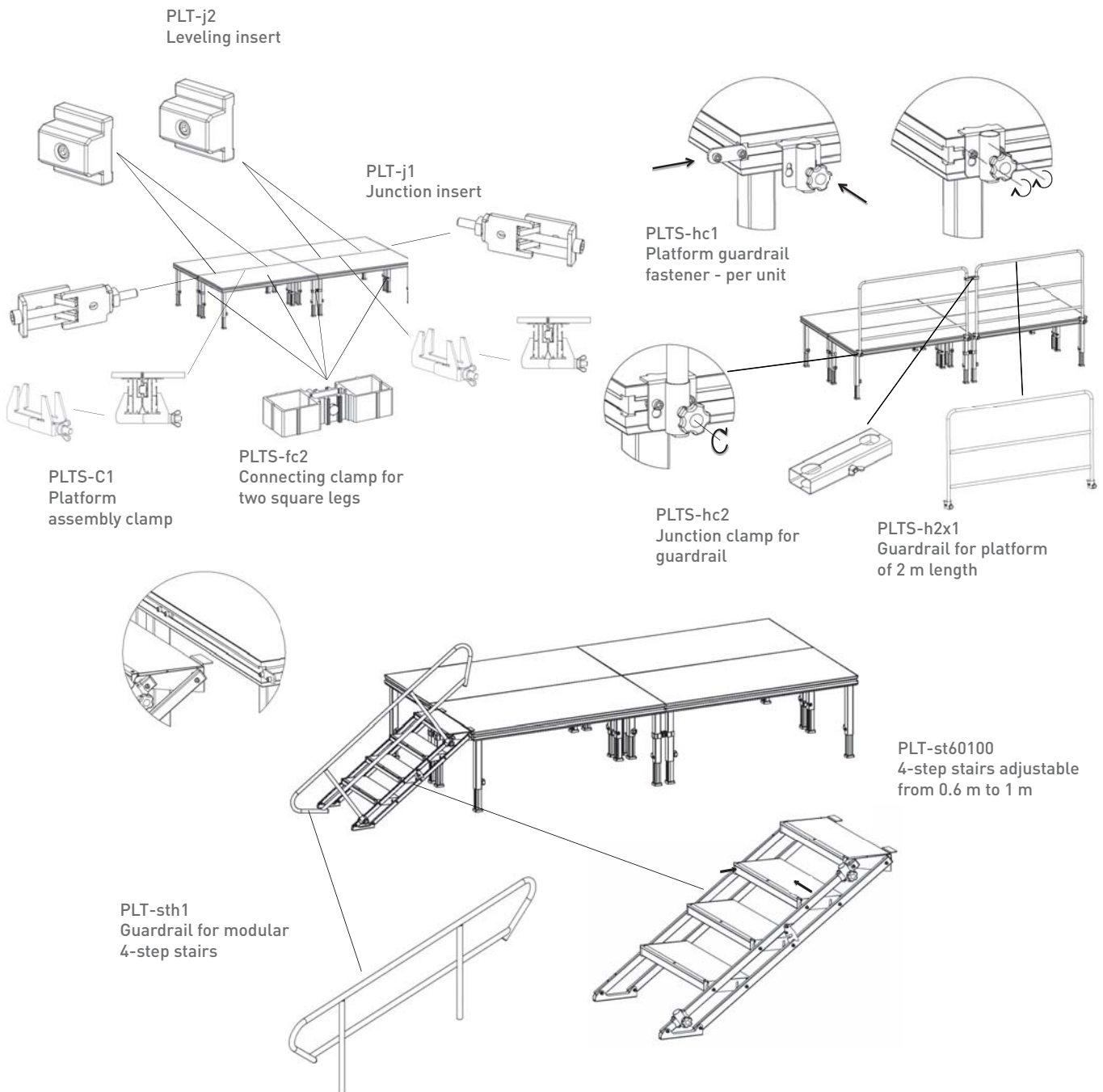

### ATTENTION ON THE SOIL CAPACITY

Soft ground can affect the safety of the installation.  
Please spread the loads evenly across the platform surface.

### ABOUT THE GUARDRAIL & STAIRS

A guardrail must be installed when the height is greater than 50 cm.  
Stairs less than or equal to 120 cm wide must have at least one handrail.

### CAUTION IN ACCORDANCE WITH THE NF E85-015 STANDARD

A maximum height of 150 cm is allowed. A guardrail must be installed if the height to be climbed is greater than 50 cm.  
These provisions are not exhaustive. For other prescriptions, obtain the standard quoted above.



# PLATFORMS



NEW

## BT-STAGE RS-PLF-2X1M

2x1m platform 750kg/m non-slip<sup>2</sup>- black - delivered without legs

Code : B03704



Material:  
 - Frame: Aluminium  
 - Tray: 12mm multi-ply  
 Thickness: 90 mm  
 Allowable distributed load: 750 Kg/m<sup>2</sup>  
 Weight: 32 Kg



NEW

## BT-STAGE RS PLF-2X0.5M

Platform 2x0.5m non-slip 750 kg/m<sup>2</sup>- black - Delivered without legs

Code : B03705



Material:  
 - Frame: Aluminium  
 - Tray: 12mm multi-ply  
 Thickness: 90 mm  
 Allowable distributed load: 750 Kg/m<sup>2</sup>  
 Weight: 16 Kg



NEW

## BT-STAGE RS PLF-1X1M

2x1m platform 750kg/m non-slip<sup>2</sup>- black - delivered without legs

Code : B03706



Material:  
 - Frame: Aluminium  
 - Tray: 12mm multi-ply  
 Thickness: 90 mm  
 Allowable distributed load: 750 Kg/m<sup>2</sup>  
 Weight: 18.3 Kg



## BT-STAGE-PLFCLAMP-BIG

Platform assembly clamp

Code : B03721



Material: Steel  
 Thickness: 4 mm  
 Weight: 0.42 Kg



## BT-STAGE-PLFCLAMP-SMALL (2pcs)

Code : B03720



Material: Steel  
 Thickness: 3 mm  
 Weight: 78 g each



## BT-STAGE-PLFLEVEL (6pcs)

Code : B03724



Leveling insert  
 Material: ABS  
 Weight: 11 g each





**BT-STAGE-LEGADJ-45/60CM**

Telescopic round leg – 0.45m to 0.60m

Code : B03712



Material: Aluminium  
Thickness: 3 mm  
diameter: 48 mm  
Weight: 1.78 Kg



**BT-STAGE-LEGADJ-60/90 CM**

Telescopic round leg – 0.60m to 0.90m

Code : B03713



Material: Aluminium  
Thickness: 3 mm  
diameter: 48 mm  
Weight: 2.37 Kg



**BT-STAGE-LEGFIX-20CM**

Round leg, fixed height = 20cm, +/- 5cm adj.

Code : B03716



Material: Aluminium  
Adjustable leg: up to 5 cm  
Thickness: 3 mm  
diameter: 48 mm  
Weight: 0.30 Kg



**BT-STAGE-LEGFIX-40CM**

Round leg, fixed height = 40cm, +/- 5cm adj.

Code : B03710



Material: Aluminium  
Adjustable leg: up to 5 cm  
Thickness: 3 mm  
diameter: 48 mm  
Weight: 0.49 Kg



**BT-STAGE-LEGFIX-60CM**

Round leg, fixed height = 60cm, +/- 5cm adj.

Code : B03711



Material: Aluminium  
Adjustable leg: up to 5 cm  
Thickness: 3 mm  
diameter: 48 mm  
Weight: 0.72 Kg



**BT-STAGE-LEGFIX-80CM**

Round leg, fixed height = 80cm, +/- 5cm adj.

Code : B03714



Material: Aluminium  
Adjustable leg: up to 5 cm  
Thickness: 3 mm  
diameter: 48 mm  
Weight: 0.82 Kg



**BT-STAGE-LEGFIX-100CM**

Round leg, fixed height = 100cm, +/- 5cm adj.

Code : B03715



Material: Aluminium  
Adjustable leg: up to 5 cm  
Thickness: 3 mm  
diameter: 48 mm  
Weight: 1.18 Kg



**BT-STAGE-LEGCLAMP-4**

Connecting clamp for four round legs

Code : B03723



Material: Steel  
Thickness: 5 mm  
Weight: 1.6 Kg



**BT-STAGE-LEGCLAMP-2**

Connecting clamp for two round legs

Code : B03722



Material: Steel  
Thickness: 5 mm  
Weight: 0.9 Kg



# PLATFORMS



## PLTL-1x1

Mobile platform 1m x 1m - 500 kg/m<sup>2</sup> - black Delivered without legs

Code : H10395



Material: Aluminium/multi-ply 12mm  
Dimensions 1 x 1 m  
Thickness: 55 mm  
Allowable distributed load: 500 Kg/m<sup>2</sup>  
Finish: Black  
Weight: 12.10 Kg



## PLT-j1

Junction insert

Code : H10372



Compatible with PLTL and PLTS series  
Material: Steel  
Thickness: 3 mm  
Weight: 78 g



## PLT-j2

Leveling insert

Code : H10373



Compatible with PLTL and PLTS series  
Material: ABS  
Weight: 11 g



## PLTL-Clip

Code : H10604



PLTL series platform support clip (to be combined with PLTL-CON)



## PLTL-Con

Code : H10605



PLTL series platform support junction connector (to be combined with PLTL-CLIP)

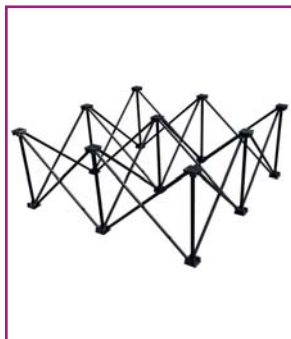

## PLTL-f20

Support for mobile platform 1 x 1m - height 20cm

Code : H10396



Material: Aluminium + ABS  
Finish: Black  
Operating height: 20 cm  
Folded height: 46.4 cm  
Weight: 2.6 Kg

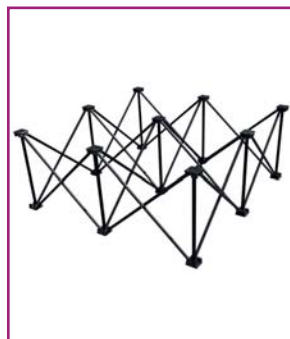

## PLTL-f40

Support for mobile platform 1 x 1m - height 40cm

Code : H10397



Material: Aluminium + ABS  
Finish: Black  
Operating height: 40 cm  
Folded height: 57.4 cm  
Weight: 3.5 Kg



## PLTL-f60

Support for mobile platform 1x1m - height 60cm

Code : H10398



Material: Aluminium + ABS  
Finish: Black  
Operating height: 60 cm  
Folded height: 72.6 cm  
Weight: 4.5 Kg



**BT-EASYSTAGE-1x1M**

Mobile platform 1m x 1m - 500 kg/m<sup>2</sup> - black Delivered without legs

Code : B03760



Material: Aluminium/multi-ply 12mm  
 Dimensions 1 x 1 m  
 Thickness: 55 mm  
 Allowable distributed load: 500 Kg/m<sup>2</sup>  
 Finish: Black  
 Weight: 12.10 Kg

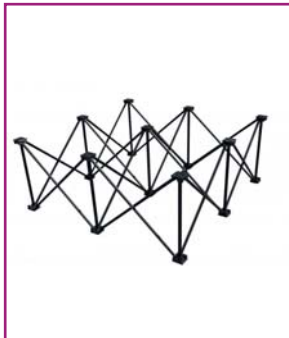

**BT-EASYSTAGE-RISER-20CM**

BT-EASYSTAGE platform support 1x1m - height 20cm

Code : B03761



Material: Aluminium + ABS  
 Finish: Black  
 Operating height: 20 cm  
 Folded height: 46.4 cm  
 Weight: 2.6 Kg

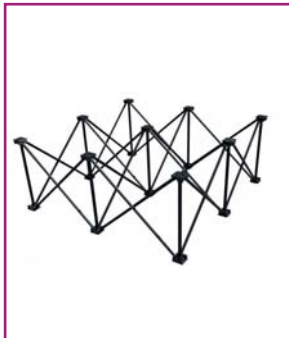

**BT-EASYSTAGE-RISER-40CM**

BT-EASYSTAGE platform support 1x1m - height 40cm

Code : B03762



Material: Aluminium + ABS  
 Finish: Black  
 Operating height: 40 cm  
 Folded height: 57.4 cm  
 Weight: 3.5 Kg

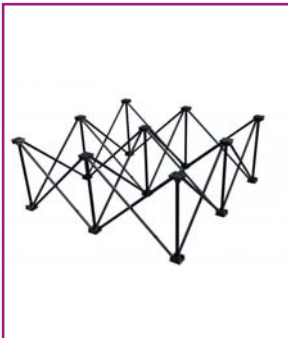

**BT-EASYSTAGE-RISER-60CM**

BT-EASYSTAGE platform support 1x1m - height 60cm

Code : B03763



Material: Aluminium + ABS  
 Finish: Black  
 Operating height: 60 cm  
 Folded height: 72.6 cm  
 Weight: 4.5 Kg



**BT-STAGE-PLFCLAMP-SMALL (2pcs)**

Code : B03720



Material: Steel  
 Thickness: 3 mm  
 Weight: 78 g each



**BT-STAGE-PLFLEVEL (6pcs)**

Code : B03724



Leveling insert  
 Material: ABS  
 Weight: 11 g each

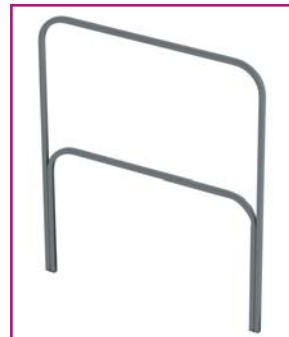

**PLTL-h1x1**

Guardrail for platform - length 1 m

Code : H10399



Material: Steel  
 Finish: Black  
 Section: 25 x 25 mm  
 Weight: 4.46 Kg

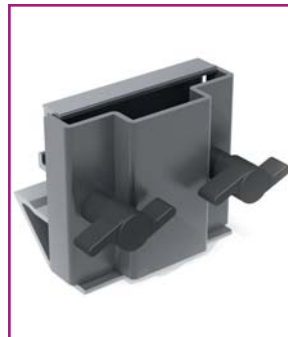

**PLTL-hc1**

Guardrail fastener for mobile platform - per unit

Code : H10400



Material: Steel  
 Finish: Grey  
 Weight: 0.45 Kg



# PLATFORMS



## PLTL-JU20x100

Finishing skirt for PLTL platform H20cm  
L105cm

Code : H10469



## PLTL-JU40x100

Finishing skirt for PLTL platform H40cm  
L105cm

Code : H10470



## PLTL-JU60x100

Finishing skirt for PLTL platform H60cm  
L105cm

Code : H10471

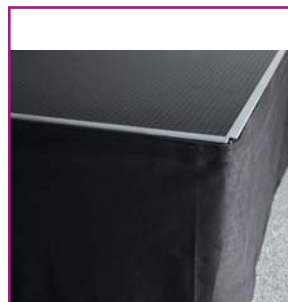

## PLTL-JU80x100

Finishing skirt for PLTL platform H80cm  
L105cm

Code : H10472



## PLTL-JU100x100

Finishing skirt for PLTL platform H100cm  
L105cm

Code : H10473



## PLTL-JU20x200

Finishing skirt for PLTL platform H20cm  
L205cm

Code : H10474



## PLTL-JU40x200

Finishing skirt for PLTL platform H40cm  
L205cm

Code : H10475



## PLTL-JU60x200

Finishing skirt for PLTL platform H60cm  
L205cm

Code : H10476



## PLTL-JU80x200

Finishing skirt for PLTL platform H80cm  
L205cm

Code : H10477



## PLTL-JU100x200

Finishing skirt for PLTL platform H100cm  
L205cm

Code : H10478



## PLTL-JUSUP

Fastening profile for PLTL-JU skirts L105cm

Code : H10479





**BT-STAGE-PLFRAIL-1M**  
Guardrail for platform of 1m length Supplied with fasteners

Code : B03742



Material: Aluminium  
Thickness: 2 mm  
Diameter: 35 mm  
Weight: 2.83 Kg  
Length: 1 m  
Height: 1.2 m



**BT-STAGE-PLFRAIL-2M**  
Guardrail for platform of 2m length Supplied with fasteners

Code : B03743



Material: Aluminium  
Thickness: 2 mm  
Diameter: 35 mm  
Weight: 3.49 Kg  
Length: 2 m  
Height: 1.2 m



**BT-EASY STAGE-TRANSPORT 1**  
BT-EASYSTAGE transport tray -1x1M.

Code : B03764



Transport tray for 15 BT-EASYSTAGE platforms -1x1M  
4 wheels  
2 nylon straps  
Weight: 25kg



**FLY6PLTL1**  
Flight case for 6 PTLT-1x1 with legs

Code : H10430



Flight case on wheels for transporting 6 PTLT-1x1 platforms, 6 legs and accessories



**BT-STAGE-TROLLEY**  
Platform transport trolley

Code : B03750



Transport trolley up to 20 platforms of 2m x1m  
Total length: 230cm  
Total height: 96cm  
Weight: 46 Kg



**PLT-TROLL**  
Platform transport trolley

Code : H10424



Transport trolley for 2x1 platforms



**PLT-BOARD**  
Platform transport trays

Code : H10423



2 transport trays  
4 braked castors per tray delivered without strap





# PLATFORMS



## PLT-st4060

Stairs adjustable from 0.4 m to 0.6 m - 2 steps

Code : H10383



Frames: Steel  
Finish: Black  
Step: 12mm multi-ply  
Weight: 16.2 Kg



## PLT-st60100

Stairs adjustable from 0.6 m to 1 m - 4 steps

Code : H10384



Frames: Steel  
Step: 12mm multi-ply  
Finish: Black  
Weight: 30 Kg



## PLT-st80140

Stairs adjustable from 0.8m to 1.4m - 5 steps

Code : H10404



Frames: Steel  
Step: 12mm multi-ply  
Finish: Black  
Weight: 37.46 Kg



## PLT-sth1

Guardrail for adjustable stairs

Code : H10385



Material: Aluminium  
Thickness: 2 mm  
Diameter: 35 mm  
Weight: 3.79 Kg  
Length: 2.3 m  
Height: 0.76 m



## BT-STAGE-STAIRS-20+40CM

Modular 2-step stairs - heights 20 and 40 cm

Code : B03740



Frames: Steel  
Steps: 12mm multi-ply  
Finish: Black  
Weight: 20.61 Kg



## BT-STAGE-STAIRS-60CM

Modular 1-step stairs - height 60 cm

Code : B03741



Frames: Steel  
Step: 12mm multi-ply  
Finish: Black  
Weight: 12.15 Kg



## BT-STAGE-STAIRS-80CM

Modular 1-step stairs - height 80 cm

Code : B03744



Frames: Steel  
Step: 12mm multi-ply  
Finish: Black  
Weight: 13.46 Kg



## BT-STAGE-STAIRS-RAIL3

Guardrail for stairs

Code : B03745



Material: Aluminium  
Thickness: 2 mm  
Diameter: 35 mm  
Weight: 3.4 Kg  
Length: 228.5 cm  
Support included



**PLT-stm20**

Modular 1-step stairs - height 20 cm

Code : H10386



Frames: Steel  
 Step: 12mm multi-ply  
 Finish: Black  
 Weight: 9.61 Kg



**PLT-stm40**

Modular 2-step stairs - heights 20 and 40 cm

Code : H10387



Frames: Steel  
 Steps: 12mm multi-ply  
 Finish: Black  
 Weight: 20.61 Kg



**PLT-stm60**

Modular 1-step stairs - height 60 cm

Code : H10388



Frames: Steel  
 Step: 12mm multi-ply  
 Finish: Black  
 Weight: 12.15 Kg



**PLT-stm80**

Modular 1-step stairs - height 80 cm

Code : H10389



Frames: Steel  
 Step: 12mm multi-ply  
 Finish: Black  
 Weight: 13.46 Kg



**PLT-sth2**

Guardrail for modular stairs - length 140cm

Code : H10390



Material: Aluminium  
 Thickness: 2 mm  
 Diameter: 35 mm  
 Weight: 3.4 Kg



 **Hilec**  
LIGHT & SOUND ACCESSORIES

**Premium Series**

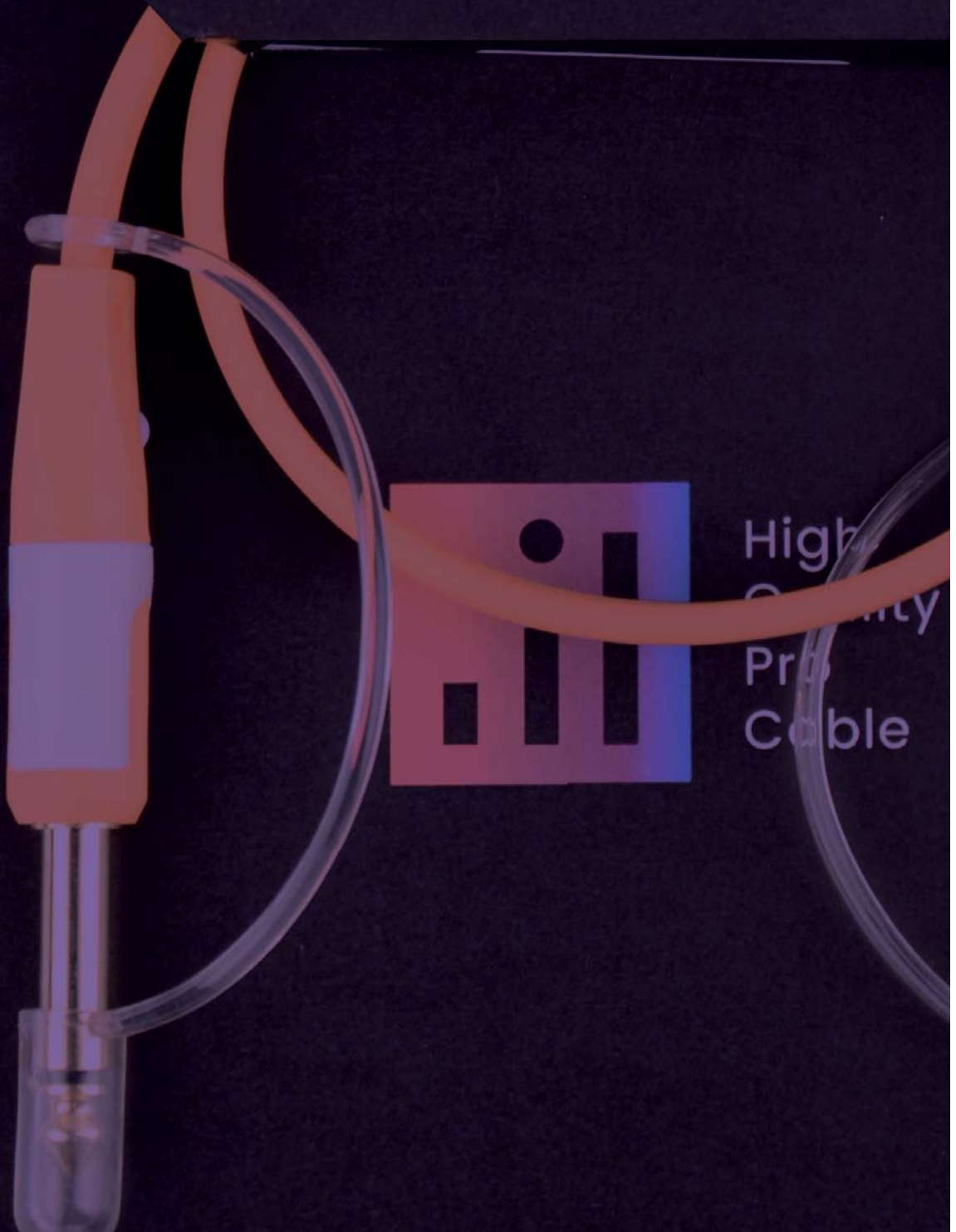

# ACCESSORIES

LIGHTING STANDS AND LIGHT  
BRIDGE

SPEAKER AND MICROPHONES  
STANDS

MICROPHONE ACCESSORIES  
STANDS

WALL BRACKETS

PROTECTIVE COVERS

BATTERIES

GAFFAS

COLOURING

GOOSENECK LIGHTS

LINE AUDIO CABLES

MICROPHONE CABLES

SPEAKER CABLES

HYBRID AUDIO CABLES

DMX LIGHTING CABLES

HYBRID LIGHTING CABLES

POWER CABLES

USB CABLES

VIDEO CABLES

AUDIO CABLE

LIGHTING CABLE

ELECTRICAL CABLE

NEUTRIK CONNECTORS  
CONNECTORS

ADAPTERS

ELECTRICAL CONNECTORS

CONSTRUCTION ACCESSORIES

LOUDSPEAKERS AND FILTERS

LAMPS



# STANDS AND LIGHT BRIDGES



## POT-DJ

Sound and light bridge for DJ  
Length: 1.20 m - Height: 2.50 m

Code : H8257



Net weight: 18.5 Kg  
Light bridge height: 2.15 to 2.51 m  
Light bridge width: 2.4 m  
Stand height: 83 cm  
Stand width: 1.2 m  
Bars section: 30 x 30 mm  
Diameter of vertical tubes: 28 mm  
Number of holes: 12  
Maximum load: 50 Kgs distributed  
Materials:  
- Steel  
- ABS for the knobs  
Finish: matte black epoxy paint



## POT-BAG

POT-DJ light bridge bag  
With divider

Code : H8260



Quick fastener closure  
Material: 600x600D polyester  
3 separate spaces for the bars  
A large space for the upstanding bars of the stand  
Lateral strap  
Diameter of each space: 12 cm  
Small side length: 125 cm  
Large side length: 140 cm  
Width: 56 cm  
20 cm flap



## POT-330

Light bridge with steel structure  
Length: 3.00 m Height: 3.20 m

Code : H8259



Net weight: 21.6 Kg  
Light bridge height: 1.49 to 3,18 m  
Light bridge width:  
3 m (2x 1.5 m trusses)  
Number of holes: 10  
Supported load: 80 Kg distributed  
Dimension of each stand on the ground:  
1.2 m  
Diameter of the stand tubes: 28 mm  
Materials:  
- Steel  
- ABS for the wheels  
Finish: matte black epoxy paint

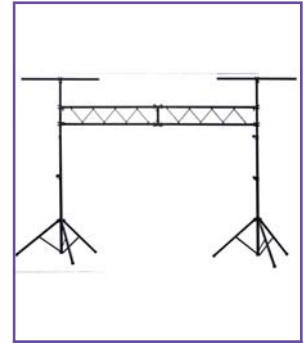

## LB-30

Light bridge: 2stand+truss,  
H3.25m - B4.2m -100kg

Code : B00755



Multifunctional aluminium economical bridge  
Consisting of 2 stands with T-bar and 2 bridge elements  
The 2 stands with T-bar can be used separately!  
Perfect for the mobile DJ; can be stored in any type of car!  
Distributed load up to 100kg!  
Distance between the stands = 3m  
Total width with installed T-bars = 4.2m  
Maximum height = 3.25m



## PID-100

Robust double crossbar stand, all-metal  
Height 3 m ø28

Code : H8252



Net weight: 5.3 Kg  
Height: from 1.48 to 3.13m  
Folded height: 1.23 m  
Tripod diameter: 1.4 m  
Supported load: 30 Kg  
Final tube diameter: 28 mm  
Tripod with double crossbars  
Materials:  
- Steel for tubes, tripod and crossbars  
- Rubber for the ends of the tubes  
- ABS for the knobs  
Finish: matte black epoxy paint



## PID-240

Stand + all-metal bar Height 2.40 m ø28

Code : H8253



Net weight: 6.7 Kg  
Height: from 1.49 to 2.40 m  
Folded height: 1.23 m  
Tripod diameter: 1.2 m  
Supported load: 30 Kg  
Diameter of the final tube: 28 mm  
Horizontal bar length: 1 m  
Single crossbar tripod  
Materials:  
- Steel for tubes, tripod and cross  
- Rubber for the ends of tubes  
- ABS for the knobs  
Finish: matte black epoxy paint



## LST-32

Light stand + T-bar, extendable - H3.18m/  
B1.5m/30kg

Code : B00756



Very stable folding lighting bracket with 100cm T-bar  
Robust design with 3 telescopic steel sections.  
Perfect for mounting all kinds of projectors and small lighting effects  
Maximum load: 30kg  
Net weight: 6.53 Kg  
Max. height: 3.18 m



## PID-380

3m stand with bar and maximum load of 80 kg

Code : H10489



Net weight: 11.2 Kg  
Height: from 1.87 to 3 m  
Folded height: 1.59 m  
Tripod diameter: 1.3 m  
Supported load: 80 Kg  
Diameter of the final tube: 35 mm  
Length of the horizontal bar: 1.5 m  
Horizontal bar diameter: 35 mm  
Tripod with double crossbars  
Materials:  
- Steel for tubes, tripod and crossbars  
- Rubber for the ends of tubes  
- ABS for the knobs  
Finish: matte black epoxy paint





### LS-64

Lighting stand – 3.10m / 80kg

Code : B00732



### FLOOR4

Projector floor stand with M10 screw

Code : H9666



### PROJECTOR FLOOR STAND

Projector floor stand with M10 screw

Code : B04947



### STAND-FLOOR

Floor plate for projector

Code : H9116



Multifunctional professional stand can be used as speaker stand or lighting stand  
Can be used as lighting stand with the TB-66 bar, available as an option.  
Max. load: 80kg



### PID1-BAG

Code : H10012

Customized for PID-100 and PID-240 stands  
Maximum diameter: 16 cm  
Maximum height: 125 cm



### PID2-BAG

Code : H10013

Customized for PID-100 and PID-240 stand  
Maximum diameter: 20 cm  
Maximum height: 125 cm



### BRE-120

Code : H8256

Internal diameter of the stand adaptor: 28 mm  
Bar length: 1.20 m  
Bar section: 30 x 30 mm  
Number of holes: 4  
Materials: Steel and ABS for the knob  
Finish: matte black epoxy paint  
Net weight: 1.6 Kg



### BRE-50

Code : H8845

Length: 1.5 m / round section: 50 mm  
Stand adaptor for 35 mm stands  
Weight: 3.6 kg



### TB-66

Code : B00733

T-Bar for LS-64  
Mounting of up to 12 projectors  
Equipped with fixing hardware  
Length = 150cm  
Designed for mounting on standard 35mm mast top



### TB-64

Code : B00743

Steel T-Bar (30x30mm)  
Mounting up to 8 projectors  
Equipped with fixing hardware  
Length = 120cm  
Planned for mounting on standard 35mm mast top



### T 150

Code : B02616

Truss adaptor for 150mm truss  
Suitable for all our stands that have a ø35mm mast top



### DJ-TRUSS 200

Code : B00739

Very strong and compact steel truss, section 150  
Length = 2m

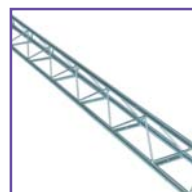

### DJ-TRUSS 150

Code : B00740

Very strong and compact steel truss, section 150  
Length = 1.5m



### SST-20

Code : H8262

For PT20-150 truss only  
Bar length: 21 cm  
Section of the bar: 30 x 20 mm  
Internal diameter of the stand adaptor: 28 mm  
M8 screw for fastening the truss  
Finish: matte black epoxy paint  
Weight: 0.40 Kg



NEW

### SST-22

Code : H10873

Stand adaptor with 35mm tube for 220 truss



# SPEAKER STANDS



**SS-POWERLIFT**  
Speaker stand, expandable 1.80m / 60kg

Code : B00749



Special locking mechanism for safe and reliable operation: no need for a safety pin!  
Spring mechanism with air cushion: Prevents the speaker from falling quickly  
Allows easy height adjustment while there is a heavy speaker on the stand, even with one hand.  
Load capacity: 60kgs Max.



**SS-AIR**  
Speaker stand, expandable pneumatic brake - 1.80m / 60kg

Code : B00734



Professional aluminium speaker stand, equipped with a special air cushion system!  
To avoid any accident, the speaker goes down slowly instead of "falling" on its base  
Very stable construction with metal base  
Low minimum height: facilitates placement of the speaker on the stand!  
Max load: 60kg



**CAB-200**  
All-metal speaker stand Height 2 m

Code : H8245



Net weight: 4.5 Kg  
Height: from 1.41 to 2.10 m  
Folded height: 1.08 m  
Tripod diameter: 1.2 m  
Supported load: 40Kg  
Diameter of the final tube: 35 mm  
Tripod with single crossbars  
Materials:  
Steel for tubes and tripod  
Rubber for the ends of tubes  
ABS for the knobs  
Finish: matte black epoxy paint



**SS-59**  
Speaker stand, extendable - 2.05m / 40kg

Code : B00737



Professional speaker stand  
Very stable construction with metal base  
Low minimum height: facilitates placement of the speaker on the stand  
Max load: 40kg



**CAB-100**  
Speaker stand with small tripod diameter

Code : H8246



Net weight: 3.1 Kg  
Height: from 0.92 to 1.40 m  
Folded height: 76 cm  
Tripod diameter: 0.70 m  
Supported load: 30 Kg  
Tube diameter: 35 mm  
Materials:  
- Steel for tubes and tripod  
- Rubber for the ends of tubes  
- ABS for the wheels  
Finish: matte black epoxy paint



**TUB-LINK**  
83 to 123cm telescopic pole with pin

Code : H9105



Telescopic pole  
Diameter of the upper part: 35mm  
Diameter of the lower part: 35mm  
Height: 83 cm to 123 cm  
Load capacity: 30kg



**SPEAKER POLE (M20 thread)**  
Telescopic pole

Code : B00659



Telescopic pole  
Diameter of the upper part: 35mm  
Bottom thread: 20mm  
Height: 76 cm to 1.16 m  
Load capacity: 30kg



**VP-130**  
Telescopic pole

Code : B00655



This special stand offers you the possibility to place a speaker from 0.7m to 1.3m



**TWIN SPEAKER  
BRACKET Mk2**  
Adapter for 2 speakers on one stand

Code : B00763



Adapter for installing 2 speakers on a single stand.  
The distance between the speakers can be adjusted between 32 and 51cm.  
Solid steel construction.  
For speakers up to 2x 20kg  
Adapter diameter: D=35mm



**FORK**  
Separate 42 cm double 35mm adapter for speakers up to 40Kg

Code : H7916



Adapter for the installation of 2 speakers on a single stand.  
Distance between speakers: 42cm.  
Solid steel construction.  
For speakers up to 40 Kg  
Diameter of the adapter: D=35mm



**CABSET**  
Set of 2 speaker stands + 1 bag

Code : H10069



**STANDS:**  
Net weight: 4.7 Kg  
Height: from 1.23 to 2.02 m  
Folded height: 1.04 m  
Tripod diameter: 1.2 m  
Supported load: 40 Kg  
Diameter of the final tube: 35 mm  
Tripod with single crossbars  
Materials:  
- Steel for tubes and tripod  
- Rubber for the ends of tubes  
- ABS for the knobs  
Finish: matte black epoxy paint  
**COVER:**  
Slide-fastener (zipper)  
Customized for CAB-100 and CAB-200 stands  
Divider  
Adjustable strap  
Maximum diameter: 20 cm  
Maximum height: 110 cm



**CAB1-BAG**  
Bag for 1 speaker stand

Code : H10010



Customized for Audiophony CAB-100 and CAB-200 stands  
Adjustable strap  
Maximum diameter: 16 cm  
Maximum height: 110 cm



**CAB2-BAG**  
Bag for 2 speaker stands

Code : H10011



Customized for Audiophony CAB-100 and CAB-200 stands  
Divider  
Adjustable strap  
Maximum diameter: 20 cm  
Maximum height: 110 cm



**BAG-STAND**  
Nylon bag for stands intended for lighting effects or sound system elements

Code : B00741



Stylish and durable nylon bag for stands intended for lighting effects or sound system elements  
Perfect for SS-59, SS-AIR, LST-32 stands



# MICROPHONE STANDS



## MIC-200T

Microphone stand with telescopic boom with heavy baseplate - adjustable height

Code : H8236



Microphone stand with telescopic boom with heavy baseplate  
 Net weight: 5.3 Kg  
 Height: from 92 cm to 1.52 m  
 Baseplate diameter: 25.5 cm  
 Thread at the boom tip: 3/8"  
 Boom length: 55 to 90 cm  
 Materials:  
 - Aluminium for the boom hinge  
 - Steel for the tubes and baseplate  
 - Rubber for the ends of tubes  
 - ABS for the knobs and the boom tip  
 Finish: matte black epoxy paint



## MIC-100

All-metal microphone boom tripod with adjustable height

Code : H8235



Net weight: 2.9 Kg  
 Height: from 1.05 to 1.60 m  
 Tripod diameter: 72 cm  
 Thread at the end of the pole: 3/8"  
 Boom length: 74 cm  
 Materials:  
 - Aluminium for the tripod and boom hinge  
 - Steel for the tubes  
 - Rubber for the ends of tubes  
 - ABS for the knobs and the pole tip  
 Finish: matte black epoxy paint



## MS-26PRO

Adjustable height all-metal pole tripod

Code : B00765



Professional microphone stand with adjustable boom  
 Robust and resistant magnesium base  
 Very good stability  
 Boom length: 64cm  
 Thread at the end of the pole: 3/8"



## MIS10

Microphone stand + bag

Code : H10068



STAND  
 Net weight: 1.8 Kg  
 Height: from 95 cm to 1.48 m  
 Tripod diameter: 70 cm  
 Thread at the end of the pole: 3/8"  
 Length of the pole: 77 cm  
 Materials:  
 - ABS for the tripod and boom hinge  
 - Steel for tubes  
 - Rubber for the ends of tubes  
 - ABS for the knobs and the pole tip  
 Finish: matte black epoxy paint  
 COVER  
 Slide-fastener (zipper)  
 Material: Polyester  
 Customized for Audiophony MIC-100T and MIS10 microphone stands  
 Maximum diameter: 10 cm  
 Maximum height: 110 cm



## MS-27

Straight universal microphone stand

Code : B00766



Straight universal microphone stand  
 Base in thick cast iron, covered with a beautiful layer of plastic.  
 Base diameter: 25cm  
 Thread at the end of the pole: 3/8"



## MS-25

Adjustable height all-metal pole tripod

Code : B00764



Microphone stand with adjustable swivel boom  
 Solid nylon base  
 Very good stability  
 Pole length: 64cm  
 Thread at the end of the pole: 3/8"



## MIC5-BAG

Bag for 5 microphone stands

Code : H10009



Customized for the Audiophony MIC-100 stand  
 5 separate spaces  
 Lateral strap  
 Max. diameter of each space: 10 cm  
 Height of each space: 100 cm  
 28 cm flap



## MIC1-BAG

Bag for 1 microphone stand

Code : H10008



Customized for the Audiophony MIC-100 stand  
 Side handle  
 Maximum diameter: 10 cm  
 Maximum height: 104 cm



### BAG-MIC

Nylon bag for microphone stand

Code : B00742



Stylish and durable nylon bag for microphone stand  
Perfect for MS-25 and MS-26PRO stands



### TMIC100

Flexible arm for microphone with XLR cable and table mounting

Code : H10458



### TMIC-20

Microphone table stand with heavy base - height 30 cm

Code : H8232



Net weight: 3,3 Kg  
Height: 30 cm  
Diameter of the base: 22 cm  
Thread at the end of the pole: 3/8"  
Length of the pole: 74 cm  
Materials:  
Steel  
Rubber on the base  
ABS for the knob and the boom tip  
Finish: matte black epoxy paint



### JB50

Microphone table stand with heavy base - microphone thread : 3/8"

Code : B00702



Microphone table stand  
Heavy base  
Robust design  
Telescopic microphone arm:  
Min. length: 320mm  
Max. length: 565mm



### TMIC-10

Microphone table stand - height 18 cm

Code : H8231



Net weight: 0.24 Kg  
Height: 18 cm  
Tripod diameter: 26 cm  
Thread at the end of the pole: 3/8"  
Materials:  
Steel  
Rubber for the ends of tubes  
Finish: matte black epoxy paint



### JB52

Microphone table stand, thread: 3/8"

Code : B00700



Microphone table stand.  
Innovative design, fully foldable.  
thread: 3/8"  
Height: 170mm



### JB55

Straight table base for microphone

Code : B00704



Straight table base (24 cm to 40 cm)



### JB85

Gooseneck 50cm for microphones

Code : B00709



Flexible gooseneck, length 50 cm



### JB88

Base for gooseneck (JB85)

Code : B00710





# MICROPHONE ACCESSORIES



**JB70**  
Universal clamp for quick-attaching microphone

Code : B00707



Universal clamp for quick-attaching microphone



**JB71**  
Universal clamp for microphone

Code : B00412



Universal clamp for micro  
Soft material: does not scratch



**A415**  
Spring microphone clamp

Code : H0180



Material: ABS  
Maximum opening diameter: 40mm



**A602**  
Insert microphone clamp

Code : H1078



Material: Rubber  
Supplied with 3/8 to 5/8 insert



**PM38**  
3/8 rubber microphone clamp

Code : H9929



Material: Rubber  
3/8 brass insert



**AD38**  
Microphone clamp adapter 3/8 to 5/8

Code : H9930



**JB75**  
Metal reduction 5/8 to 3/8 (10 pieces)

Code : B00711

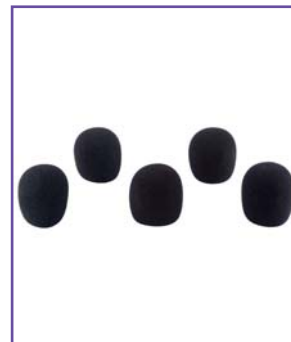

**WINDSCREEN BLACK**  
Set of 5 black foams.

Code : B00415



**WINDSCREEN COLOURED**  
Set of 5 foams in different colors.

Code : B00416



**WS-3**  
Black microphone windscreen

Code : H3686



# STANDS



## KB4

Keyboard stand with double crossbars - Magnesium series

Code : H9663



Net weight: 4.5 Kg  
 Height: from 58 to 98 cm  
 Width: from 80 to 82 cm  
 Length of the upper tubes: 40 cm  
 Supported load: 50 Kg max.  
 Locking brake  
 Materials:  
 - Steel for the tubes and bars  
 - Rubber for the ends of tubes  
 Finish: anthracite epoxy paint



## KB-UNO

Keyboard stand

Code : H8226



Net weight: 2.2 Kg  
 Height: from 60 cm to 93 cm  
 Distance of horizontal crossbars: from 32 cm to 80 cm  
 Crossbar length: 30 cm  
 Materials:  
 - Steel for the stand  
 - Rubber for the ends of tubes  
 Maximum load: 25 Kg  
 Finish: matte black epoxy paint



## KB-ROLL

Controller or keyboard stand with integrated trolley.

Code : H8224



Net weight: 6.1 Kg  
 Height: from 60 cm to 120 cm  
 Distance of horizontal crossbar: from 32 cm to 87 cm  
 Length of crossbar: 40 cm  
 Materials:  
 - Steel for the stand  
 - ABS for retractable bars  
 - Rubber for the ends of tubes  
 - Nylon for the strap  
 Maximum load: 50 Kg  
 Finish: matte black epoxy paint



## KB-BAG

Bag for 1 controller or keyboard stand

Code : H10007



Customized for Audiophony KB-ROLL, KB-UNO and KB4 stands  
 Side handle  
 Maximum width: 50 cm  
 Maximum height: 100 cm  
 Maximum thickness of the folded stand: 5 cm



## KB-EXT70

Extension for control stand - inclined

Code : H8227



Net weight: 1.5 Kg  
 Height: 24 cm  
 Crossbar incline: 70° compared to the vertical  
 Crossbar length: 30 cm  
 Materials:  
 - Steel for the stand  
 - ABS for the knob  
 - Rubber for the ends of tubes  
 Finish: matte black epoxy paint



## KB-EXT90

Extension for control stand - straight

Code : H8228



Net weight: 1.5 Kg  
 Height: 24 cm  
 Crossbar incline: horizontal  
 Length of the traverse: 30 cm  
 Materials:  
 - Steel for the support  
 - ABS for the knob  
 - Rubber for the ends of tubes  
 Finish: matte black epoxy paint



## DJ4

Magnesium series DJ control stand

Code : H9665



Net weight: 15 Kg  
 Height: from 68 to 92 cm  
 Dimensions of the main tray: 45 x 100 cm  
 Dimensions of the top tray: 30 x 60 cm  
 Materials:  
 - Steel for the tubes, bars and trays  
 - ABS for tube tips and knobs  
 Finish: anthracite epoxy paint



# SUPPORTS



## MEDIAsage1

Aluminium stand for mobile phones

Code : H10495



For 3.5 to 5.5 inch phones  
 Material: Aluminium  
 Dimensions (WxHxD): 38 x 381 x 25 mm  
 Folded dimensions (WxHxD):  
 38 x 168 x 25 mm  
 Arm length (unfolded): 238 mm  
 Stand depth: 17,5 mm  
 Stand height: 57 to 89 mm  
 Weight: 130 grams



## MEDIAsage2

Aluminium stand with clamp for mobile phones and tablets

Code : H10496



Suitable for smartphones and tablets from 4 to 11 inches  
 Aluminium structure, 500g  
 Maximum load 1 kg



## MEDIAsage3

Aluminium stand with 1 suction cup for tablets and smartphones

Code : H10494



Suitable for smartphones and tablets from 4 to 11 inches  
 Aluminium structure, 500g  
 Maximum load 1 kg



## MEDIAsage4

Aluminium stand with double suction cups for tablets and smartphones

Code : H10493



Suitable for smartphones and tablets from 4 to 11 inches  
 Aluminium structure, 500g  
 Maximum load 1 kg



## MEDIAsage5

Aluminium stand with 1 suction cup for mobile phones and tablets

Code : H10654



## MEDIAsage6

Aluminium stand for mobile phones and tablets

Code : H10655



Suitable for smartphones and tablets from 4 to 11 inches  
 Aluminium structure, 500g  
 Maximum load 1 kg



## MEDIA2

Tablet holder to attach to microphone stand

Code : H10457



## TABLET HOLDER

Universal tablet holder for microphone stand. Screens from 7" to 11"

Code : B00767





**LAPTOP STAND**  
Universal computer stand

Code : B03195



**MEDIA4**  
Magnesium series adjustable multimedia stand

Code : H9664



**MEDIA3**  
Laptop stand with table mounts

Code : H10456



Universal laptop stand  
Easily attaches to the vertical parts of your flight bag  
Easily attaches to a table  
Adaptable in many ways, thanks to intelligent design:  
Adaptable width, thanks to 4 expansion adapters: 235mm to 285mm  
Adaptable height: 250mm to 380mm  
Durable and stable metal design in black finish.  
All accessories (buttons, table/rack clamps, extension adapter) are included.  
Weight: 2.3kg (all included)  
Max. height: 380mm  
Minimum height: 250mm  
Max. width: 285mm  
Min. width: 235mm

Net weight: 2.8 Kg  
Height: from 17 to 30 cm  
Width (from the top): from 29 to 39 cm  
Materials:  
- Steel  
- ABS for the knobs and bar tips  
Finish: anthracite epoxy paint



<b>A</b>	<b>SUPPLAT</b> Code : H7903	Plastic support plate for 36 mm stand Platinum 180 x 120 mm		<b>B</b>	<b>EYE-10</b> Code : H8843	Eyebolt without M10 screws - 230 Kg	
<b>C</b>	<b>EYE-08</b> Code : H8842	Eyebolt without M8 screws - 140 Kg		<b>D</b>	<b>M10 Eyebolt (4 pcs)</b> Code : B00658	Eyebolt without M10 screws (4 pcs)	
<b>E</b>	<b>M8 Eyebolt (4 pcs)</b> Code : B00657	Eyebolt without M8 screws (4 pcs)		<b>F</b>	<b>H00K-12</b> Code : H8844	Harp shackle 12 mm - 500 Kg	
<b>G</b>	<b>CPL-35</b> Code : H8248	Cup with M8 screw for 35 mm stand		<b>H</b>	<b>C-35</b> Code : H8247	Metal speaker baseplate	
<b>I</b>	<b>C-36</b> Code : H1077	Metal speaker base		<b>J</b>	<b>CPL-12</b> Code : H3239	Super reinforced cup Diameter 12 cm	
<b>K</b>	<b>CO-12</b> Code : B02645	Reinforced cup ø12cm.		<b>L</b>	<b>CPL-28</b> Code : H8255	Cup with M8 screw For 28 mm stand	
<b>M</b>	<b>VELCRO-30</b> Code : H8876	VELCRO 25 x 300 mm strap		<b>N</b>	<b>VELCRO-60</b> Code : H8877	VELCRO 45 x 600 mm strip	
<b>O</b>	<b>COLL520</b> Code : H10442	Reusable clamping collar 48x200mm-100 pieces		<b>P</b>	<b>COLL825</b> Code : H10443	Reusable clamping collar 76x250 mm-100 pieces	



# WALL BRACKETS



<b>A</b>	SUPWALL Code : H9104	Adjustable wall mount for speakers up to 40Kg
<b>C</b>	BS/6-1 Code : H7906	Adjustable wall mount for speakers up to 20kg
<b>E</b>	WB-L30 Code : B00761	Wall mount 30cm, 40kg
<b>G</b>	iLINE24sup Code : H10773	Adjustable wall bracket for iLINE23 and iLINE43
<b>I</b>	iLINEbase Code : H10760	Floor bracket for iLINE83B and iLINESPACE60
<b>K</b>	iLINE43sup Code : H10755	Wall bracket for iLINE43 column
<b>M</b>	iLINE24sup Code : H10773	Adjustable wall bracket for iLINE23 and iLINE43
<b>O</b>	CUB-Wall1 Code : H10730	Wall bracket for CUBsat4
<b>Q</b>	CUB-Truss1 Code : H10732	Suspension support for CUBsat4
<b>S</b>	SUP-AC08WH Code : H9599	ACUTE08 monitor hanging bracket - white
<b>U</b>	SUPS6/WH Code : H9706	Mounting bracket for S6 satellite - white
<b>W</b>	SUPS8/WH Code : H9708	Mounting bracket for S8 satellite - white
<b>Y</b>	SUPS10/WH Code : H9710	Mounting bracket for S10 satellite - white
<b>A1</b>	Bracket for SC-12 Code : B09185	Robust Foldable Stand for SC-12 Speaker

<b>B</b>	BS/5-1 Code : H7907	Articulated wall baseplate for large speakers up to 40 Kg
<b>D</b>	WB-L20 Code : B00760	Wall mount 20cm, 40kg
<b>F</b>	BYR Code : H1075	Wall mount for rotating speaker
<b>H</b>	iLINEspace60 Code : H10759	Increase height by 60cm for iLINE83B with stackable connector base
<b>J</b>	iLINE83sup Code : H10757	Wall bracket for iLINE83 column
<b>L</b>	iLINE23sup Code : H10753	Wall bracket for iLINE23 column
<b>N</b>	CUB-BRACKET Code : H10666	Bumper suspension for mini line array head
<b>P</b>	CUB-Pole1 Code : H10731	Foot support for CUBsat4
<b>R</b>	SUP-AC08NO Code : H9598	ACUTE08 monitor hanging bracket - black
<b>T</b>	SUPS6/NO Code : H9705	Hanging bracket for S6 satellite - black
<b>V</b>	SUPS8/NO Code : H9707	Mounting bracket for S8 satellite - black
<b>X</b>	SUPS10/NO Code : H9709	Mounting bracket for S10 satellite - black
<b>Z</b>	Bracket for SC-08 Code : B09184	Robust foldable stand for SC-08 speaker
<b>B1</b>	Bracket for SC-15 Code : B09186	Robust Foldable Stand for SC-15 Speaker



# PROTECTIVE COVERS



<b>A</b>	COV-MOJ0500LINE Code : H10867	Protective cover for MOJ0500LINE subwoofer
<b>C</b>	COV-SX15A Code : H10855	Protective bag for SX15A
<b>E</b>	iLINEcov Code : H10768	Protective bag for iLINE series subwoofers
<b>G</b>	COV-ATOM12A Code : H10785	Protective bag for ATOM12A
<b>I</b>	COV-ATOM15ASUB Code : H10787	Protective bag for ATOM15ASUB
<b>K</b>	COV-SR15 Code : H10169	Bag for SR15A speaker
<b>M</b>	COV-SR10 Code : H10167	Bag for SR10A speaker
<b>O</b>	COV-MOJ01000FX Code : H10350	Travel bag + trolley for MOJ01000FX
<b>Q</b>	COV-CR25A Code : H10791	Protective bag for CR25A-COMBO
<b>S</b>	COV-CR80A Code : H10431	Bag for CR80A-COMBO loudspeaker
<b>U</b>	COV-CROSS Code : H9985	Carrying bag for CROSSER loudspeakers
<b>W</b>	TOURING BAG Code : B00597	Carrying bag for PS-15/PSA-15
<b>Y</b>	TOURING BAG - Vibe 15 Code : B00592	Carrying bag for Vibe 15
<b>A1</b>	TOURING BAG - Vibe 18 SUB Code : B00595	Carrying Bag for Vibe 18 SUB!!!!
<b>C1</b>	COV-SRSUB18A Code : H10887	Bag for COV-SRSUB18A subwoofer

<b>B</b>	COV-SX12A Code : H10854	Protective bag for SX12A
<b>D</b>	iLINEbag Code : H10767	Carrying bag for 2 iLINE 8 HP columns or 2 iLINEspace 60
<b>F</b>	COV-ATOM10A Code : H10784	Protective bag for ATOM10A
<b>H</b>	COV-ATOM15A Code : H10786	Protective bag for ATOM15A
<b>J</b>	COV-ATOM18ASUB Code : H10788	Protective bag for ATOM18ASUB
<b>L</b>	COV-SR12 Code : H10168	Bag for SR12A speaker
<b>N</b>	COV-SRSUB15A Code : H10351	Protective bag for SRSUB15A subwoofer
<b>P</b>	COV-BOOMBOX Code : H10488	Carrying bag for BOOMBOX
<b>R</b>	COV-CR12A Code : H10208	Bag for CR12A-COMBO loudspeaker
<b>T</b>	COV-SPRINT Code : H9986	Carrying bag for SPRINTER loudspeakers
<b>V</b>	TOURING BAG - PS-12/PSA-12 Code : B00596	Protective cover for PS-12, PSA-12, PPA-121
<b>X</b>	TOURING BAG - Vibe 12 Code : B00591	Carrying bag for Vibe 12
<b>Z</b>	TOURING BAG - Vibe 15 SUB !!!! Code : B00594	Carrying bag for Vibe 15 SUB!!!!
<b>B1</b>	TOURING BAG - Vibe 30 Code : B00593	Carrying bag for Vibe 30



# BATTERIES



<b>A</b>	PILE-LR03	Blister alkaline battery 4 x 1.5 V	Code : H8147
<b>B</b>	PILE-LR06	Blister alkaline battery 4 x 1.5 V	Code : H8148
<b>C</b>	PILE-6LR61	Blister alkaline battery 1 x 9 V	Code : H8146
<b>D</b>	PILE-VI-6LR61	VARTA INDUSTRIAL 9V battery (in blister of 20)	Code : H10743
<b>E</b>	PILE-VI-LR6	VARTA INDUSTRIAL 1.5V LR6 battery (in blister of 10)	Code : H10744
<b>F</b>	PILE-VI-LR3	VARTA INDUSTRIAL 1.5V LR3 battery (in blister of 10)	Code : H10745
<b>G</b>	PILE-VCR2025	VARTA CR2025 button battery (in blister of 10)	Code : H10746



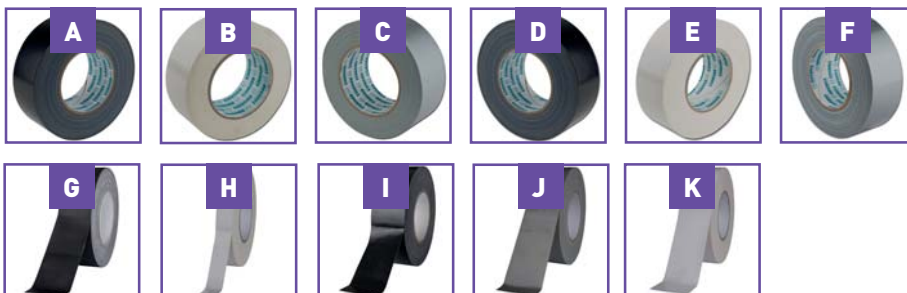













# GAFFAS



<b>A</b>	GAFFA-STD/NO	Gaffa 50mm x 50m standard black	Code : H3955
<b>B</b>	GAFFA-STD/WH	Roll of 50m x 5cm - White	Code : H8872
<b>C</b>	GAFFA-STD/GR	Roll of 50m x 5cm - Grey	Code : H8873
<b>D</b>	GAFFA-PRO/NO	Gaffa 50mm x 50m professional black	Code : H3956
<b>E</b>	GAFFA-PRO/WH	Roll of 50 m x 5 cm canvas - White	Code : H8874
<b>F</b>	GAFFA-PRO/GR	Roll of 50m x 5cm canvas - Grey	Code : H8875
<b>G</b>	GAFFER TAPE MATT 50 BLACK	High quality matt black canvas tape of 50m x 5 cm.	Code : B06104
<b>H</b>	GAFFER TAPE STD 25 WHITE	High quality white tape 50m x 25mm.	Code : B06103
<b>I</b>	GAFFER TAPE STD 50 BLACK	High quality black canvas tape 50m x 5 cm.	Code : B06100
<b>J</b>	GAFFER TAPE STD 50 GREY	High-quality grey canvas tape 50m x 5 cm.	Code : B06101
<b>K</b>	GAFFER TAPE STD 50 WHITE	High-quality white canvas tape 50m x 5 cm.	Code : B06102

# COLOURING



<b>A</b>	COLOR FILTER Sheet «Congo Blue 181”	1.22 x 0.53m "Congo Blue 181" colour sheet	Code : B04564	
<b>B</b>	COLOR FILTER Sheet «Dark Green 124”	1.22 x 0.53m "Dark Green 124" colour sheet	Code : B04566	
<b>C</b>	COLOR FILTER Sheet «Magenta 113”	1.22 x 0.53m "Magenta 113" colour sheet	Code : B04567	
<b>D</b>	COLOR FILTER Sheet «Mauve 126”	1.22 x 0.53m "Mauve 126" colour sheet	Code : B04569	
<b>E</b>	COLOR FILTER Sheet «Medium Blue-Green”	1.22 x 0.53m "Medium Blue-Green" colour sheet	Code : B04568	
<b>F</b>	COLOR FILTER Sheet «Orange 105”	1.22 x 0.53m "Orange 105" colour sheet	Code : B04561	
<b>G</b>	COLOR FILTER Sheet «Primary Green 139”	1.22 x 0.53m "Primary Green 139" colour sheet	Code : B04565	
<b>H</b>	COLOR FILTER Sheet «Primary Red 106”	1.22 x 0.53m "Primary Red 106" colour sheet	Code : B04562	
<b>I</b>	COLOR FILTER Sheet «Sky Blue 068”	1.22 x 0.53m "Sky Blue 068" colour sheet	Code : B04563	
<b>J</b>	COLOR FILTER Sheet «Vanity Fair 793”	1.22 x 0.53m "Vanity Fair 793" colour sheet	Code : B04570	
<b>K</b>	COLOR FILTER Sheet «Yellow 101”	1.22 x 0.53m "Yellow 101" colour sheet	Code : B04560	
<b>L</b>	FILTER SHEETS PAR56 PRO- 10 col.	Set of filters, 10 different colours	Code : B04553	
<b>M</b>	FILTER SHEETS PAR56 PRO- 5 col.	Set of filters, 5 different colours	Code : B04552	
<b>N</b>	FILTER SHEETS PAR56 SH - 10 col.	Set of filters, 10 different colours	Code : B04551	
<b>O</b>	FILTER SHEETS PAR56 SH - 5 col.	Set of filters, 5 different colours	Code : B04550	
<b>P</b>	FILTER SHEETS PAR64 PRO- 10 col.	Set of filters, 10 different colours	Code : B04555	
<b>Q</b>	FILTER SHEETS PAR64 PRO- 5 col.	Set of filters, 5 different colours	Code : B04554	



# GOOSENECK LIGHTS



**Hilec**  
LIGHT & SOUND ACCESSORIES

<b>A</b>	Snake16USB	Flexible lamp with 6 white COB LEDs - USB	Code : H10802
<b>B</b>	Snake16	1-arm desk lamp with 6 white COB LEDs	Code : H10803
<b>C</b>	Snake23DUO	2-arm desk lamp with 3 white COB LEDs	Code : H10804
<b>D</b>	Snake118DeskW	Desk lamp with 18 warm white COB LEDs	Code : H10805
<b>E</b>	Snake118DeskC	Desk lamp with 18 cool white COB LEDs	Code : H10806
<b>F</b>	Snake16M	Flexible LED lamp + magnetic baseplate + Battery	Code : H10807
<b>G</b>	Snake26Rack	2-arm USB rack light with white LEDs	Code : H10808
<b>H</b>	Snake16RGBUSB	Flexible lamp with 6 RGB COB LEDs - USB	Code : H10809
<b>I</b>	COB LED CLIP LIGHT WW	Very powerful 30cm flexible gooseneck lamp with clip	Code : B00226
<b>J</b>	COB LED MINILIGHT WW	Very powerful 30cm flexible gooseneck lamp	Code : B00224
<b>K</b>	COB LED RACKLIGHT WW	Very powerful 30cm flexible gooseneck lamp for rack	Code : B00227

# LINE AUDIO CABLES



<b>A</b>	CFLAT-XXMF/0.5 Code : H10810	XLR male / XLR female flat cable - 0.5m	<b>K</b>	CL-41/1.5 Code : H10674	2 x XLR male / 2 x stereo male jack cable - 1.5m
	CFLAT-XXMF/1 Code : H10811	XLR female / XLR male flat cable - 1m		CL-41/3 Code : H10675	2 x XLR male / 2 x stereo male jack cable - 3m
	CFLAT-XXMF/1.5 Code : H10812	XLR female / XLR male flat cord - 1.5m	<b>L</b>	CL-42/1.5 Code : H10676	2 x XLR female / 2 x mono male jack cable - 1.5m
<b>B</b>	CFLAT-JSJS/0.5 Code : H10813	TRS jack / TRS jack flat cable - 0.5m		CL-42/3 Code : H10677	2 x XLR female / 2 x mono male jack cable - 3m
	CFLAT-JSJS/1 Code : H10814	TRS jack / TRS jack flat cable - 1m	<b>M</b>	CL-43/1.5 Code : H10678	2 x XLR female / 2 x stereo male jack cable - 1.5m
	CFLAT-JSJS/1.5 Code : H10815	Jack TRS / Jack TRS flat cord - 1.5m		CL-43/3 Code : H10679	2 x XLR female / 2 x stereo male jack cable - 3m
<b>C</b>	CFLAT-JSXF/0.5 Code : H10816	TRS Male / XLR Female 6.35 jack flat cable - 0.5m	<b>N</b>	CL-2XM2XF/0.6 Code : H10680	2 x XLR Male / 2 x XLR Female cable - 0.6m
	CFLAT-JSXF/1 Code : H10817	TRS Male / XLR Female 6.35 jack flat cable - 1m		CL-2XM2XF/1.5 Code : H10681	2 x XLR female / 2 x XLR Male cable - 1.5m
	CFLAT-JSXF/1.5 Code : H10818	XLR Female / Jack 6.35 TRS Male flat cord - 1.5m		CL-2XM2XF/3 Code : H10682	2 x XLR Male / 2 x XLR female cable - 3m
<b>D</b>	CFLAT-JSXM/0.5 Code : H10819	TRS Male / XLR Male 6.35 jack flat cable - 0.5m		CL-2XM2XF/6 Code : H10683	2 x XLR Male / 2 x XLR female cable - 6m
	CFLAT-JSXM/1 Code : H10820	TRS Male / XLR Male 6.35 jack flat cable - 1m	<b>O</b>	ADAPT2010 Code : H10697	Female / 2 x RCA male 3.5 jack cable
	CFLAT-JSXM/1.5 Code : H10821	XLR Male / Jack 6.35 TRS Male flat cord - 1.5m	<b>P</b>	ADAPT2020 Code : H10698	1 stereo male 3.5 jack / 2 stereo female 3.5 jack cable - Black
<b>E</b>	CFLAT-RCA/0.5 Code : H10822	RCA male / RCA male flat cable - 0.5m	<b>Q</b>	CL-05/1.5 Code : H7976	Male 6mm jack / Mono male jack line cable - 1.5m
	CFLAT-RCA/1 Code : H10823	RCA male / RCA male flat cable - 1m		CL-05/3 Code : H7977	Male 6mm jack / Mono male jack line cable - 3m
	CFLAT-RCA/1.5 Code : H10824	RCA male / RCA male flat cord - 1.5m		CL-05/6 Code : H7978	Male 6mm jack / Mono male jack line cable - 6m
<b>F</b>	CFLAT-JMJM/0.5 Code : H10825	6.35 J mono / 6.35 J mono flat cable - 0.5		CL-05/10 Code : H7979	Male 6mm jack / Mono male jack line cable - 10m
	CFLAT-JMJM/1 Code : H10826	Mono 6.35 jack / mono 6.35 jack flat cable - 1	<b>R</b>	CL/JMJM-1,5 Code : H7980	Male jack / Mono male jack line cable - 1.5m
	CFLAT-JMJM/1.5 Code : H10827	J 6.35 Mono / J 6.35 mono flat cord - 1.5		CL/JMJM-3 Code : H7981	Male jack / Mono male jack line cable - 3m
<b>G</b>	CL-32/1.5 Code : H10668	Stereo / 2 x XLR male 3.5 jack cable - 1.5m		CL/JMJM-6 Code : H7982	Male jack / Mono male jack line cable - 6m
	CL-32/3 Code : H10669	Stereo / 2 x XLR male 3.5 jack cable - 3m		CL/JMJM-10 Code : H7983	Male jack / Mono male jack line cable - 10m
<b>H</b>	CL-28/0.6 Code : H10670	1 XLR female / 2 x XLR male cable - 0.6m		CL/JMJM-20 Code : H7984	Male jack / Mono male jack line cable - 20m
<b>I</b>	CL-29/0.6 Code : H10671	1 XLR male / 2 x XLR female cable - 0.6m			
<b>J</b>	CL-40/1.5 Code : H10672	2 x mono 6.35 jack / 2 x XLR male cable - 1.5m			
	CL-40/3 Code : H10673	2 x mono 6.35 jack / 2 x XLR male cable - 3m			





# LINE AUDIO CABLES



<b>A</b>	CL-07/1.5 Code : H7995	Stereo Male jack / stereo Male jack line cable - 1.50m	<b>H</b>	CL-26/1.5 Code : H8167	2x4mm 2xXLR Male / 2xRCA Male line cable - 1.5m
	CL-07/3 Code : H7996	Stereo Male jack / stereo Male jack line cable - 3m		CL-26/3 Code : H8168	2x4mm 2xXLR Male / 2xRCA Male line cable - 3m
	CL-07/6 Code : H7997	Stereo Male jack / stereo Male jack line cable - 6m	<b>I</b>	FL-22/1.5 Code : H8012	2x4mm 2x Male jack / 2x Mono male jack line cable - 1.5m
	CL-07/10 Code : H7998	Stereo Male jack / stereo Male jack line cable - 10m		FL-22/3 Code : H8013	2x4mm 2x Male jack / 2x Mono male jack line cable - 3m
<b>B</b>	CL-71/1.5 Code : H7999	Stereo Male 3.5 mm jack / stereo Male 6.35 jack line cable - 1.50m		FL-22/6 Code : H8014	2x4mm 2x Male jack / 2x Mono Male jack line cable - 6m
	CL-71/3 Code : H8000	Stereo Male 3.5 mm jack / stereo Male 6.35 jack line cable - 3m	<b>J</b>	CL-31/1.5 Code : H8015	2x4mm 1x stereo Male 3.5 jack / 2x Male jack line cable - 1.5m
	CL-71/6 Code : H8001	Stereo Male 3.5 mm jack / stereo Male 6.35 jack line cable - 6m		CL-31/3 Code : H8016	2x4mm 1x stereo Male 3.5 jack / 2x Male jack line cable - 3m
	CL-71/10 Code : H8002	Stereo Male 3.5 mm jack / stereo Male 6.35 jack line cable - 10m	<b>K</b>	CL-30/1.5 Code : H8017	2x4mm 1x stereo Male 3.5 jack / 2xRCA Male line cable 1.5m
<b>C</b>	CL-72/1.5 Code : H8003	Jack 3,5 mm stereo Male / Jack 3,5 stereo Male cord line - 1.50m		CL-30/3 Code : H8018	2x4mm 1x stereo Male 3.5 jack / 2xRCA Male line cable 3m
	CL-72/3 Code : H8004	Jack 3,5 mm Stereo Male / Jack 3,5 stereo Male cord line - 3m	<b>L</b>	CL-51/0.6 Code : H9299	DIN 5-pin male / DIN 5-pin male midi cable - 0.6m
	CL-72/6 Code : H8005	Jack 3,5 mm Stereo Male / Jack 3,5 stereo Male cord line - 6m		CL-51/1 Code : H9300	DIN 5-pin male / DIN 5-pin male midi cable - 1m
	CL-72/10 Code : H8006	Jack 3,5 mm stereo Male / Jack 3,5 stereo Male cord line - 10m		CL-51/3 Code : H8019	DIN 5-pin male / DIN 5-pin male midi cable - 3m
<b>D</b>	CL-23/1.5 Code : H8007	2x4mm 2x Male jack / 2xRCA Male line cable - 1.5m		CL-51/6 Code : H8020	DIN 5-pin male / DIN 5-pin male midi cable - 6m
	CL-23/3 Code : H8008	2x4mm 2x Male jack / 2xRCA Male line cable - 3m	<b>M</b>	RCA1/C Code : H0049	2 RCA male / 2 RCA male cable - 1.2 m
<b>E</b>	CL-35/1.5 Code : H8009	2x4mm 1 stereo Male jack / 2xRCA Male line cable - 1.5m	<b>N</b>	CL-24/1.5 Code : H7964	2x4mm 2xRCA Male / 2xRCA Male line cable - 1.5m
	CL-35/3 Code : H8010	2x4mm 1 stereo Male jack / 2xRCA Male line cable - 3m		CL-24/3 Code : H7965	2x4mm 2xRCA Male / 2xRCA Male line cable - 3m
	CL-35/6 Code : H8011	2x4mm 1 stereo Male jack / 2xRCA Male line cable - 6m		CL-24/6 Code : H7966	2x4mm 2xRCA Male / 2xRCA Male line cable - 6m
<b>F</b>	CL-36/1.5 Code : H9294	Stereo male 6.35 jack / 2 x mono 6.35 jack line cable - 1.5m	<b>O</b>	CL-27/1.5 Code : H7967	2xRCA Female / 2xRCA Male line cable - 1.5m
	CL-36/3 Code : H9295	Stereo male 6.35 jack / 2 x mono 6.35 jack line cable - 3m		CL-27/3 Code : H7968	2xRCA Female / 2xRCA Male line cable - 3m
<b>G</b>	CL-25/1.5 Code : H8165	2x4mm 2xXLR Female / 2xRCA Male line cable - 1.5m		CL-27/6 Code : H7969	2xRCA Female / 2xRCA Male line cable - 6m
	CL-25/3 Code : H8166	2x4mm 2xXLR Female / 2xRCA Male line cable - 3m			



<b>A</b>	RCA11/C Code : H7970	High quality cable - 2 RCA male / 2 RCA male - 1.20m	<b>I</b>	INSERT-JACKm-1M5 Code : B01240	Insert cable - stereo jack - 2x mono jack - 1.5m
	RCA13/C Code : H7971	High quality cable - 2 RCA male / 2 RCA male - 3m		INSERT-JACKm-3M Code : B01241	Insert cable - stereo jack - 2x mono jack - 3m
	RCA15/C Code : H7972	High quality cable - 2 RCA male / 2 RCA male - 5m	<b>J</b>	JACKm/JACKm-90D-0M <sup>3</sup> Code : B01242	Multicolour Jack ←→ Jack 90° - 0.3m (6pcs)
<b>B</b>	RCA/PH Code : H7973	2 RCA male / 2 RCA male cable + mass - 3m	<b>K</b>	JACKm/JACKm-TWIN-1M5 Code : B01243	2x mono jack - 2x mono jack cable - 1.5m
<b>C</b>	RCA25/C Code : H7974	4 RCA male / 4 RCA male cable - 1.50m		JACKm/JACKm-TWIN-3M Code : B01244	2x mono jack - 2x mono jack cable - 3m
<b>D</b>	2-0365 Code : B01220	Signal cable, 2xRCA + 2xRCA 0.5m	<b>L</b>	miniJACK/2xJACK-1M5 Code : B01245	Stereo 3.5 jack - 2x mono jack cable - 1.5m
	2-0368 Code : B01221	Signal cable, 2xRCA+2xRCA 1.0m		miniJACK/2xJACK-3M Code : B01246	Stereo 3.5 jack - 2x mono jack cable - 3m
	2-0370 Code : B01222	Signal cable, 2xRCA + 2xRCA 1.5m	<b>M</b>	MJC-1M5 Code : B01217	Signal cable, 2xRCA+ stereo 3.5 jack 1.5m
	2-0375 Code : B01223	Signal cable, 2xRCA + 2xRCA 2,5m	<b>N</b>	MJMJ-1M5 Code : B01236	Male 3.5 jack / male 3.5 jack cable - 1.5m
	2-0380 Code : B01224	Signal cable, 2xRCA+2xRCA 5,0m	<b>O</b>	MJMfJ-3M Code : B01237	3.5 jack/3.5 jack extension - 3m
<b>E</b>	2-0425 Code : B01210	Signal cable, mono jack + mono jack 6m	<b>P</b>	RCAm/RCAf-TWIN-3M Code : B01247	2x RCA male ←→ 2x RCA female cable - 3m
	2-0426 Code : B01211	Signal cable, mono jack + mono jack 10m	<b>Q</b>	SJXF-1M5 Code : B01218	Balanced signal cable, Stereo Jack / XLR Female 1.5m
<b>F</b>	2-0430 Code : B01215	Signal cable, 2xRCA+ mono jack 1.5m	<b>R</b>	SJXM-1M5 Code : B01219	Balanced signal cable, Stereo Jack/ XLR Male 1.5m
	2-0435 Code : B01216	Signal cable, 2xRCA+ mono jack 3m	<b>S</b>	SNAKE-8XLRmf-3M Code : B01248	Snake cable 8x XLRm ←→ XLRf - 3m
<b>G</b>	2-0440 Code : B01235	Signal cable, 2xRCA+XLRf 1.5m		SNAKE-8XLRmf-6M Code : B01249	Snake cable 8x XLRm ←→ XLRf - 6m
<b>H</b>	2-0445 Code : B01230	Signal cable, 2xRCA+XLRm 1.5m		SNAKE-8XLRmf-9M Code : B01250	Snake cable 8x XLRm ←→ XLRf - 9m



# MICROPHONE CABLES



<b>A</b>	CM/XFXM-0,6 Code : H9298	XLR female / XLR male microphone cable - 0.6m
	CM/XFXM-1,5 Code : H7947	XLR female / XLR male microphone cable - 1.5m
	CM/XFXM-3 Code : H7948	XLR female / XLR male microphone cable - 3m
	CM/XFXM-6 Code : H7949	XLR female / XLR male microphone cable - 6m
	CM/XFXM-10 Code : H7950	XLR female / XLR male microphone cable - 10m
	CM/XFXM-20 Code : H7951	XLR female / XLR male microphone cable - 20m
<b>A1</b>	XMF-0.50M Code : B01207	Signal cable, XLRf+XLRm 0.5m
<b>B</b>	CM/XFJM-1,5 Code : H7952	XLR female / male jack microphone cable - 1.5m
	CM/XFJM-3 Code : H7953	XLR female / male jack microphone cable - 3m
	CM/XFJM-6 Code : H7954	XLR female / male jack microphone cable - 6m
	CM/XFJM-10 Code : H7955	XLR female / male jack microphone cable - 10m
	CM/XFJM-20 Code : H7956	XLR female / male jack microphone cable - 20m

<b>C</b>	CM/XMJM-1,5 Code : H9296	XLR male / mono male 6.35 jack microphone cable - 1.5m
	CM/XMJM-3 Code : H9297	XLR male / mono male 6.35 jack microphone cable - 3m
	CM/XMJM-6 Code : H7957	XLR male / mono male 6.35 jack microphone cable - 6m
	CM/XMJM-10 Code : H7958	XLR male / mono male 6.35 jack microphone cable - 10m
<b>D</b>	7-0060 Code : B01205	Signal cable, XLRf+mono jack 5m
	7-0066 Code : B01206	Signal cable, XLRf+mono jack 10m
<b>E</b>	7-0061 Code : B01203	Signal cable, XLRf+XLRm 1m
	7-0062 Code : B01204	Signal cable, XLRf+XLRm 2,5m
	7-0063 Code : B01200	Signal cable, XLRf+XLRm 5m
	7-0067 Code : B01201	Signal cable, XLRf+XLRm 10m
	7-0068 Code : B01202	Signal cable, XLRf+XLRm 20m

# SPEAKER CABLES



<b>A</b>	CH/JMJM-1.5 Code : H8023	Male jack / Male jack 2x1.5 HP cable - 1.5m
	CH/JMJM-3 Code : H8024	Male jack / Male jack 2x1.5 HP cable - 3m
	CH/JMJM-10 Code : H8025	Male jack / Male jack 2x1.5 HP cable - 10m
	CH/JMJM-15 Code : H8026	Male jack / Male jack 2x1.5 HP cable - 15m
<b>B</b>	CH/SMJM-3 Code : H8034	Speakon Male / Male jack 2x1.5 HP cable - 3m
	CH/SMJM-6 Code : H8035	Speakon Male / Male jack 2x1.5 HP cable - 6m
	CH/SMJM-10 Code : H8036	Speakon Male / Male jack 2x1.5 HP cable - 10m
	CH/SMJM-20 Code : H8037	Speakon Male / Male jack 2x1.5 HP cable - 20m
<b>C</b>	CS-21/3 Code : H8038	Speakon Male / speakon Male 2x1.5 HP cable - 3m
	CS-21/6 Code : H8039	Speakon Male / speakon Male 2x1.5 HP cable - 6m
	CS-21/10 Code : H8040	Speakon Male / speakon Male 2x1.5 HP cable - 10m
	CS-21/15 Code : H8041	Speakon Male / speakon Male 2x1.5 HP cable - 15m
	CS-21/20 Code : H8042	Speakon Male / speakon Male 2x1.5 HP cable - 20m

<b>D</b>	CSP215/0.5 Code : H10695	2 speaker cable x 1.5 mm <sup>2</sup> speakon/speakon NEUTRIK - 0.5m
	CSP215/1 Code : H10696	2 speaker cable x 1.5 mm <sup>2</sup> speakon/speakon NEUTRIK - 1m
	CSP215/3 Code : H9840	2 speaker cable x 1.5 mm <sup>2</sup> speakon/speakon NEUTRIK - 3m
	CSP215/6 Code : H9841	2 speaker cable x 1.5 mm <sup>2</sup> speakon/speakon NEUTRIK - 6m
	CSP215/10 Code : H9842	2 speaker cable x 1.5 mm <sup>2</sup> speakon/speakon NEUTRIK - 10m
<b>E</b>	2-0505 Code : B01252	Speakon Male / speakon Male HP cable - 5m
	2-0510 Code : B01253	Speakon Male / speakon Male HP cable - 10m
	2-0525 Code : B01254	Speakon Male / speakon Male HP cable - 25m

# DMX CABLES



<b>A</b>	CDU0-10 Code : H9274	VDE / CEE - XLR male / XLR female hybrid audio cable - 10 metres
	CDU0-20 Code : H9293	VDE / CEE - XLR male / XLR female Hybrid Sound Cord - 20 meters
<b>B</b>	AUDIO COMBI CABLE IEC/XLR-10M Code : B01401	IEC / XLR Male / XLR Female Hybrid Sound Cord - 10 Meters
	AUDIO COMBI CABLE IEC/XLR-20M Code : B01402	IEC / XLR Male / XLR Female Hybrid Sound Cord - 20 Meters

	AUDIO COMBI CABLE IEC/XLR-5M Code : B01400	IEC / XLR Male / XLR Female hybrid audio cable - 5 metres
<b>C</b>	AUDIO COMBI CABLE SCHUKO/XLR-10M Code : B01404	VDE / CEE - XLR male / XLR female Hybrid Sound Cord - 10 meters
	AUDIO COMBI CABLE SCHUKO/XLR-20M Code : B01405	VDE / CEE - XLR male / XLR female Hybrid Sound Cord - 20 meters
	AUDIO COMBI CABLE SCHUKO/XLR-5M Code : B01403	VDE / CEE - XLR male / XLR female Hybrid Sound Cord - 5 meters

# DMX CABLES



<b>A</b>	CDMX-0.6 Code : H10699	DMX XLR male / XLR female 3 pin cable - 0.6m
	CDMX-1 Code : H9273	Cable for DMX XLR Male / XLR female 3 pins Length: 1 m
	CDMX-1.5 Code : H9288	Cord for DMX XLR Male / XLR female 3 pins Length: 1.5 m
	CDMX-3 Code : H9289	Cord for DMX XLR Male / XLR female 3 pins Length: 3 m
	CDMX-5 Code : H9290	Cord for DMX XLR Male / XLR female 3 pins Length: 5 m
	CDMX-10 Code : H9291	Cord for DMX XLR Male / XLR female 3 pins Length: 10 m
	CDMX-20 Code : H9292	Cord for DMX XLR Male / XLR female 3 pins Length: 20 m

<b>B</b>	XLR5 M-M 0,5M Code : B01208	DMX conversion cable: 5-pin male to male XLR connectors
<b>C</b>	IPCD-1 Code : H10722	DMX 3P waterproof connection cable for IPZOOM - 1m
	IPCD-2 Code : H10723	DMX 3P waterproof connection cable for IPZOOM - 2m
	IPCD-5 Code : H10724	DMX 3P waterproof connection cable for IPZOOM - 5m



# DMX COMBI CABLES



<b>A</b>	CPCDMXLINK-1 Code : H10686	POWERCON / XLR hybrid cable 3G1.5mm <sup>2</sup> - 1m	<b>D</b>	IP-POWER/XLR COMBI CABLE 1M3* Code : B01361	Length: 1.3 m.
	CPCDMXLINK-3 Code : H10687	POWERCON / XLR hybrid cable 3G1.5mm <sup>2</sup> - 3m		IP-POWER/XLR COMBI CABLE 3M* Code : B01362	Length: 3 m.
	CPCDMXLINK-5 Code : H10688	POWERCON / XLR hybrid cable 3G1.5mm <sup>2</sup> - 5m		IP-POWER/XLR COMBI CABLE 5M* Code : B01363	Length: 5 m.
<b>B</b>	CPCDMXIN-3 Code : H10689	POWERCON-PC16A / XLR hybrid cable 3G1.5mm <sup>2</sup> - 3m	<b>E</b>	POWERCON/XLR COMBI 3x1.5mm <sup>2</sup> CABLE 1M3 Code : B01263	1.3 m POWERCON Neutrik / XLR hybrid cable 3G1.5mm <sup>2</sup>
	CPCDMXIN-5 Code : H10690	POWERCON-PC16A / XLR hybrid cable 3G1.5mm <sup>2</sup> - 5m		POWERCON/XLR COMBI 3x1.5mm <sup>2</sup> CABLE 3M Code : B01264	3m POWERCON Neutrik / XLR hybrid cable 3G1.5mm <sup>2</sup>
	CPCDMXIN-10 Code : H10691	POWERCON-PC16A / XLR hybrid cable 3G1.5mm <sup>2</sup> - 10m		POWERCON/XLR COMBI 3x1.5mm <sup>2</sup> CABLE 5M Code : B01265	5m POWERCON Neutrik / XLR hybrid cable 3G1.5mm <sup>2</sup>
<b>C</b>	COMBI CABLE IEC/ XLR 1.3m Code : B01255	Power(IEC)+DMX cable 1.3m	POWERCON/XLR COMBI 3x1.5mm <sup>2</sup> CABLE 10M Code : B01266	10m POWERCON Neutrik / XLR hybrid cable 3G1.5mm <sup>2</sup>	* Combination of a power cable 3 x 1.5 mm <sup>2</sup> (16 A max.) and a symmetrical shielded signal cable. Equipped with XLR male / female connectors and IP power.
	COMBI CABLE IEC/XLR 3M Code : B01256	Power(IEC)+DMX cable 3.0m			
	COMBI CABLE IEC/XLR 5M Code : B01257	Power(IEC)+DMX cable 5.0m			
	COMBI CABLE IEC/XLR 10M Code : B01258	Power(IEC)+DMX cable 10.0m			

# POWER CABLES





<b>A</b>	IECMF-1 Code : H9889	IEC male / female 1m cables	
	IECMF-3 Code : H9890	IEC male / female 3m cables	
	IECMF-5 Code : H9891	IEC male / female 5m cables	
	IECMF-7 Code : H9892	IEC male / female 7m cables	
<b>B</b>	CPCIN-1 Code : H10684	NAC3FCA / 3G1.5mm cable <sup>2</sup> / PC16A - 1m	
	CPCIN-2.5 Code : H10685	NAC3FCA / 3G1.5mm cable <sup>2</sup> / PC16A - 2.5m	
<b>C</b>	CPCLINK-0.5 Code : H10692	NAC3FCA / NAC3FCB 3G0.75mm cable <sup>2</sup> ET 3G2mm <sup>2</sup> - 0.5m	
	CPCLINK-1 Code : H10693	NAC3FCA / NAC3FCB 3G0.75mm cable <sup>2</sup> ET 3G2mm <sup>2</sup> - 1m	
	CPCLINK-1.5 Code : H10694	NAC3FCA / NAC3FCB 3G0.75mm cable <sup>2</sup> ET 3G2mm <sup>2</sup> - 1.5m	
<b>D</b>	IPCP-1 Code : H10725	Waterproof electrical connection cable for IPZOOM -1m	
	IPCP-2 Code : H10726	Waterproof electrical connection cable for IPZOOM -2m	
	IPCP-3 Code : H10776	Waterproof electrical connection cable for IPZOOM-3m	
	IPCP-5 Code : H10727	Waterproof electrical connection cable for IPZOOM -5m	
<b>E</b>	ALIM315/3 Code : H9848	Extension cable with rubber plugs H07RN- F3G1.5 - 3m	
	ALIM315/5 Code : H9849	Extension cable with rubber plugs H07RN- F3G1.5 - 5m	
	ALIM315/10 Code : H9850	Extension cable with rubber plugs H07RN- F3G1.5 - 10m	
<b>F</b>	ALIM325/3 Code : H9851	Extension cable with rubber plugs H07RN- F3G2.5 - 3m	
	ALIM325/5 Code : H9852	Extension cable with rubber plugs H07RN- F3G2.5 - 5m	
	ALIM325/10 Code : H9853	Extension cable with rubber plugs H07RN- F3G2.5 - 10m	
<b>G</b>	MULT6E Code : H10841	European extension socket 6 outlets	
<b>H</b>	MULT4E Code : H10842	Power outlets 4 European outlets	
<b>I</b>	MULTIP6F Code : H10843	French extension socket 6 outlets - IP44	
<b>J</b>	MULTIP6E Code : H10844	European extension socket 6 outlets - IP44	
<b>K</b>	MULTIP4F Code : H10845	Power outlets 4 French sockets - IP44	
<b>L</b>	MULTIP4E Code : H10846	Power outlets 4 European outlets - IP44	
	IECEUR3 Code : H10869	IEC female / Europe male cable - 3m / 3G1mm <sup>2</sup>	
<b>M</b>	IECEUR5 Code : H10870	IEC female / Europe male cable - 5m / 3G1mm <sup>2</sup>	
	CPCIN3 Code : H10871	Europe male / SEETRONIC cable - 3m / 3G1.5mm <sup>2</sup>	
<b>N</b>	CPCIN5 Code : H10872	Europe male / SEETRONIC cable - 5m / 3G1.5mm <sup>2</sup>	
	CEE-CABLE-32A-5G6-10M* Code : B01392		
<b>O</b>	CEE-CABLE-32A-5G6-20M* Code : B01393		
	CEE-CABLE-32A-5G6-5M* Code : B01391		
	CEE-CABLE-63A-5G16-10M* Code : B01395		
<b>P</b>	CEE-CABLE-63A-5G16-20M* Code : B01396		
	CEE-CABLE-63A-5G16-5M* Code : B01394		
	Q	IEC Cable M/F 1M Code : B04151	IEC male and female cables
	IEC Cable M/F 5M Code : B04152	IEC male and female cable	
<b>R</b>	MULTISOCKET4-F** Code : B01352		
<b>S</b>	MULTISOCKET4-G** Code : B01353		
<b>T</b>	MULTISOCKET4PRO-F-3M** Code : B01387		
	MULTISOCKET4PRO-F-5M** Code : B01389		
<b>U</b>	MULTISOCKET4PRO-G-3M** Code : B01388		
	MULTISOCKET4PRO-G-5M** Code : B01390		
<b>V</b>	POWER CABLE CEE7/7-IEC 2M Code : B01350	CEE7/7-IEC power cable 2M	
<b>W</b>	POWER CABLE CEE7/7-PowerCON 2M Code : B01351	Power cable CEE7/7 - PowerCON	
<b>X</b>	POWERCABLE-3G1,5-10M-F Code : B01377	Extension cable 3G1.5, 10m and French Schuko plug	
<b>Y</b>	POWERCABLE-3G1,5-10M-G Code : B01380	Extension cable 3G1.5, 10m and German Schuko plug	
<b>Z</b>	POWERCABLE-3G1,5-3M-F Code : B01375	Extension cable 3G1.5, 3m and French Schuko plug	
<b>A1</b>	POWERCABLE-3G1,5-3M-G Code : B01378	Extension cable 3G1.5, 3m and German Schuko plug	
<b>B1</b>	POWERCABLE-3G1,5-5M-F Code : B01376	Extension cable 3G1.5, 5m and French Schuko plug	
<b>C1</b>	POWERCABLE-3G1,5-5M-G Code : B01379	Extension cable 3G1.5, 5m and German Schuko plug	
<b>D1</b>	POWERCABLE-3G2,5-10M-F Code : B01382	Extension cable 3G2.5, 10m and French Schuko plug	
<b>E1</b>	POWERCABLE-3G2,5-10M-G Code : B01385	Extension cable 3G2.5, 10m and German Schuko plug	
<b>F1</b>	POWERCABLE-3G2,5-20M-F Code : H10833	Extension cable 3G2.5, 20m and French Schuko plug	
<b>G1</b>	POWERCABLE-3G2,5-20M-G Code : B01386	Extension cable 3G2.5, 20m and German Schuko plug	
<b>H1</b>	POWERCABLE-3G2,5-5M-F Code : B01381	Extension cable 3G2.5, 5m and French Schuko plug	
<b>I1</b>	POWERCABLE-3G2,5-5M-G Code : B01384	Extension cable 3G2.5, 5m and German Schuko plug	
<b>J1</b>	POWERCABLE-3G2,5-3M-F Code : B01397	Extension cable 3G2.5, 3m and French Schuko plug	
<b>K1</b>	POWERCABLE-3G2,5-3M-G Code : B01398	Extension cable 3G2.5, 3m and German Schuko plug	
<b>L1</b>	CABLE CASE Code : B03244	Extra solid flight case specially designed to carry cables and other heavy objects.	

\*\*4-outlet power distribution box with sliding mounting bracket and transparent heat-shrinkable sheath for custom labels.

\*5-pole CEE extension cable with transparent heat-shrinkable sheath for custom labels.



# USB CABLES



<b>A</b>	CU/AMAF Code : H9271	USB2.0 A male / A female cable - 5m		
<b>B</b>	CU/AMBM-1 Code : H9272	USB2.0 A male / USB2.0 B male cable - 1m		
	CU/AMBM-5 Code : H9287	USB2.0 A male / USB2.0 B male cable - 5m		
<b>C</b>	USB2 A-B 2M Code : B01273	USB2 A-B 2M		
	USB2 A-B 3M Code : B01274	USB2 A-B 3M		
<b>D</b>	USB3 A-B 2M Code : B01275	USB3 A-B 2M		
	USB3 A-B 3M Code : B01276	USB3 A-B 3M		

# INSTALLATION CABLE AUDIO



<b>A</b>	PROMI/20 Code : H8099	6 mm black microphone cable - 100m coil		
<b>B</b>	PROMI/30 Code : H8100	6 mm black high quality microphone cable 100 m		
<b>C</b>	MEP/ASY Code : H8103	Flat cable 2 x 4 mm <sup>2</sup> asymmetrical black- 100 m coil		
<b>D</b>	MEP-2075 Code : H8104	HP flat cable 2 x 0.75mm <sup>2</sup> red and black - 100 m coil		
<b>E</b>	MEP-2150 Code : H8105	HP Flat Cable 2 x 1.5 mm <sup>2</sup> rouge et noir - bobine de 100 m		
<b>F</b>	MEP-2200 Code : H8106	HP Flat Cable 2 x 2mm <sup>2</sup> rouge et noir - bobine de 100 m		
<b>G</b>	PROHP-215 Code : H8107	HP 2 x 1.5 mm cable <sup>2</sup> black - coil 100 m		
<b>H</b>	PROHP-225 Code : H8108	HP 2 x 2.5 mm cable <sup>2</sup> black - coil 100 m		
<b>I</b>	PROHP-425 Code : H8109	HP 4 x 2.5 mm cable <sup>2</sup> black - coil 50 m		
<b>J</b>	PROHP-440 Code : H8110	HP 4 x 4 mm cable <sup>2</sup> black - 50 m coil		
<b>K</b>	DUOSOUND Code : H9855	Hybrid power cable 3 x 1.5 mm <sup>2</sup> + AUDIO - 50m		
<b>L</b>	SPR2150 Code : B01290	Round cable of very good quality 2x1.50mm <sup>2</sup> (100m coil)		
<b>M</b>	SPR2250 Code : B01291	Round cable of very good quality 2x2.50mm <sup>2</sup> (100m coil)		
<b>N</b>	SPR2400 Code : B01292	Round cable of very good quality 2x4.00mm <sup>2</sup> (50m coil)		
<b>O</b>	SPR4250 Code : B01293	Round cable of very good quality: 4x2.50mm <sup>2</sup> (50m coil)		
<b>P</b>	MC-01 Black Code : B01280	Symmetrical microphone cable of very good quality		
<b>Q</b>	MC-01 Blue Code : B01281	Symmetrical microphone cable of very good quality		
<b>R</b>	MC-01 Red Code : B01282	Symmetrical microphone cable of very good quality		

# VIDEO CABLES



<b>A</b>	HDMI 1M Code : B01270	High speed HDMI cable
	HDMI 2M Code : B01271	High speed HDMI cable
	HDMI 5M Code : B01272	High speed HDMI cable

# LIGHT CABLE

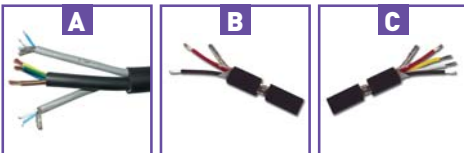

<b>A</b>	DUOLIGHT Code : H9854	Hybrid power cable 3 x 2.5 mm <sup>2</sup> + DMX - 50m
<b>B</b>	DMX-DOUB Code : H8101	DMX digital cable 2 conductors black - price per metre
<b>C</b>	DMX-QUAD Code : H8102	DMX digital cable 4 conductors black - price per meter

# ELECTRICAL CABLE



<b>A</b>	TIT-315 Code : H6755	Titanex cable LENS H07RNF 3 x 1.5 mm <sup>2</sup> 100m coil
<b>B</b>	TIT-325 Code : H6756	Titanex cable LENS H07RNF 3 x 2.5 mm <sup>2</sup> 100m coil



# NEUTRIK® connectors

	<b>NE8MC</b> Code : H10446	Cat5e RJ45 cable plug body
	<b>NE8FDP</b> Code : H10447	Female socket for CAT5e RJ45 cable
	<b>NE8FDPB</b> Code : B01145	RJ45 feedthrough receptacle, black D-shape metal flange with the latch lock
	<b>NC-3-FXX</b> Code : B01102	Neutrik XLR female connector for cable, 3-pin.
	<b>NC-3-FXX</b> Code : H8846	3-pin NEUTRIK female XLR plug
	<b>NC-3-MXX</b> Code : B01101	Neutrik XLR male connector for cable, 3-pin.
	<b>NC-3-MXX</b> Code : H8848	3-pin NEUTRIK male XLR plug
	<b>NC-3-FX-HD</b> Code : H10714	NEUTRIK 3-pole XLR female IP67 water-proof plug
	<b>NC-3-FX-HD</b> Code : H10715	NEUTRIK 3-pole XLR male IP67 water-proof plug
	<b>NC-5-FXX</b> Code : B01117	Neutrik XLR female connector for cable, 5-pin
	<b>NC-5-FXX</b> Code : H8850	5-pin NEUTRIK female XLR plug
	<b>NC-5-MXX</b> Code : B01118	Neutrik XLR male connector for cable, 5-pin
	<b>NC-5-MXX</b> Code : H8851	5-pin male XLR plug NEUTRIK
	<b>NC-3-FD-L-1</b> Code : B01127	Female XLR chassis, lockable, D-size, 3-pin from Neutrik.
	<b>NC-3FDLX</b> Code : H8852	NEUTRIK X series 3-pin female XLR socket
	<b>NC-3-MD-L-1</b> Code : B01128	Male XLR chassis, lockable, [D-size], 3 pins from Neutrik.
	<b>NC-3MDLX</b> Code : H8853	NEUTRIK X series 3-pin male XLR socket
	<b>NC-5-FDLX</b> Code : B01123	Neutrik D-size 5pin XLR-f CHASSIS
	<b>NC-5FDL1</b> Code : H4840	NEUTRIK D series 5-pin female XLR socket
	<b>NC-5-MDLX</b> Code : B01124	Neutrik D-size 5pin XLR-m CHASSIS
	<b>NC-5MDL1</b> Code : H4841	NEUTRIK D series 5-pin male XLR socket
	<b>NA-USB</b> Code : H8854	NEUTRIK D Series USB-A-B socket
	<b>NYS373-0</b> Code : H8855	NEUTRIK gold contact RCA plug - Black
	<b>NYS373-2</b> Code : H8856	NEUTRIK gold contact RCA plug - Red
	<b>NTP3RC</b> Code : H7946	NEUTRIK angled stereo 3.5 JACK plug
	<b>NP-2-X</b> Code : B01104	Neutrik 6.3mm JACK-m mono CABLE.
	<b>NP-2X</b> Code : H8859	NEUTRIK male mono 6.35 JACK plug
	<b>NP-3-X</b> Code : B01103	Neutrik 6.3mm JACK-m stereo CABLE
	<b>NP-3X</b> Code : H8861	NEUTRIK male stereo 6.35 JACK plug
	<b>NJ-3-FC-6</b> Code : B01106	Neutrik 6.3mm JACK-f stereo CABLE
	<b>NJ-3FC6</b> Code : H4846	NEUTRIK female stereo 6.35 jack plug
	<b>NJ-3-FP-6C</b> Code : B01105	Neutrik D-size stereo 6.3mm JACK-f CHASSIS
	<b>NJ-3FP6C</b> Code : H4848	NEUTRIK D series female stereo 6.35 JACK socket

	<b>NP2C-SILENT</b> Code : H8857	NEUTRIK anti-plock mono jack plug
	<b>NP2RX-SILENT</b> Code : H8858	NEUTRIK anti-plock angled mono jack plug
	<b>NC-3FRX</b> Code : H8863	3-pin NEUTRIK angled female XLR plug
	<b>NC-3MRX</b> Code : H8865	3-pin NEUTRIK angled male XLR plug
	<b>NP2RX</b> Code : B01147	Right Angle Mono Plug
	<b>NP-2RX</b> Code : H4854	NEUTRIK angled male mono 6.35 JACK plug
	<b>NP-3RX</b> Code : H4855	NEUTRIK angled male stereo 6.35 JACK plug
	<b>NL-2-FX</b> Code : B01136	Neutrik Speakon CABLE, 2 contacts.
	<b>NL-2FX</b> Code : H4856	NEUTRIK SPEAKON plug, 2 contacts
	<b>NL-4-FX</b> Code : B01113	Neutrik Speakon CABLE, 4 contacts.
	<b>NL-4FX</b> Code : H4857	NEUTRIK X series SPEAKON plug, 4 contacts
	<b>NL-4-MMX</b> Code : B01116	Neutrik 2x Speakon ADAPTER, 4 contacts.
	<b>NL-4MMX</b> Code : H4859	NEUTRIK X series SPEAKON coupler, 4 contacts
	<b>NL-2MP</b> Code : H4861	NEUTRIK D series SPEAKON socket, 2 contacts
	<b>NL-4-MP</b> Code : B01115	Neutrik Speakon CHASSIS, D-size, 4 contacts.
	<b>NL-4MP</b> Code : H4862	NEUTRIK 4-way SPEAKON 2-way socket
	<b>NL-4-MP-R</b> Code : B01114	Neutrik Speakon BIG CHASSIS, 4 contacts.
	<b>NL-4MPR</b> Code : H4863	NEUTRIK SPEAKON socket, 4 contacts, EP format
	<b>NAC3FX-W</b> Code : B01132	PowerCON TRUE1 locking female cable connector with power-in and screw terminals.
	<b>NAC3FX-W</b> Code : H10448	Powercon True one female plug
	<b>NAC3MX-W</b> Code : B01131	PowerCON TRUE1 locking male cable connector with power-out and screw terminals.
	<b>NAC3MX-W</b> Code : H10449	Powercon True one male plug
	<b>NAC3MPX</b> Code : B01134	NEUTRIK PowerCON TRUE1 appliance inlet connector with 1/4" flat tab terminals.
	<b>NAC3MPX</b> Code : H10450	Powercon True one male socket
	<b>NAC3FPX</b> Code : B01135	NEUTRIK PowerCON TRUE1 appliance outlet connector with 1/4" flat tab terminals.
	<b>NAC3FPX</b> Code : H10451	Powercon True one female socket
	<b>NAC3PX</b> Code : B01133	PowerCON TRUE1 appliance inlet-outlet combination with 1/4" flat tab terminals.
	<b>NAC-3-FCA</b> Code : B01125	Neutrik PowerCon inlet (blue) CABLE
	<b>NAC-3FCA</b> Code : H4865	NEUTRIK 240V 20A male power input plug, 3 contacts
	<b>NAC-3-FCB</b> Code : B01129	Neutrik PowerCon outlet (grey) CABLE
	<b>NAC-3FCB</b> Code : H4866	NEUTRIK 240V 20A male power output plug, 3 contacts
	<b>NAC-3-MPA</b> Code : B01126	Neutrik D-size PowerCon inlet (blue) CHASSIS
	<b>NAC-3MPA</b> Code : H4867	NEUTRIK 240V 20A power input socket, 3 contacts
	<b>NAC-3-MPB</b> Code : B01130	Neutrik D-size PowerCon outlet (grey) CHASSIS
	<b>NAC-3MPB</b> Code : H4868	NEUTRIK 240V 20A power output socket, 3 contacts

	<b>NF2D0</b> Code : H10452	RCA socket, black, D format
	<b>NF2D2</b> Code : H10453	RCA socket, red, D format
	<b>NF2D-B-2</b> Code : B01139	Red RCA socket D format
	<b>NF2D-B-9</b> Code : B01138	RCA socket, white, D format
	<b>NA-3F5M</b> Code : H4869	NEUTRIK DMX XLR 3 fem. / XLR 5 male adapter
	<b>NA-3M5F</b> Code : H4870	NEUTRIK DMX XLR 3 male / XLR 5 female adapter
	<b>SCDR</b> Code : B01144	Rear protection of size D
	<b>XXCR</b> Code : B01146	Clear ring
	<b>DBA</b> Code : B01119	cover for Neutrik D chassis

	<b>NC3FDLXBAG</b> Code : B01141	X series 3-pin female XLR socket / black - NEUTRIK
	<b>NC3MDLXBAG</b> Code : B01140	X series 3-pin male XLR socket / black - NEUTRIK
	<b>NC3FXXBAG</b> Code : B01143	3-pin female XLR plug / black - NEUTRIK
	<b>NC3MXXBAG</b> Code : B01142	3-pin female XLR plug / black - NEUTRIK
	<b>NAUSB-W-B</b> Code : B01148	D series USB-A socket / black - NEUTRIK

# ELECTRICAL CONNECTORS

	<b>CEE100</b> Code : H0227	CEE 22 chassis - male
	<b>CEE300</b> Code : H0225	CEE 22 plug - male
	<b>FIC/MAL</b> Code : H1804	Male plastic plug 2 poles + earth
	<b>FIC/CAH/MAL</b> Code : H1806	Male rubber plug 2 poles + earth
	<b>FIC/SCHU/MAL</b> Code : H8131	Male rubber plug IP44 schuko
	<b>ADAPTER IP-POWER TO POWERCON*</b> Code : B01360	
	<b>SAC3FX</b> Code : H10720	Waterproof Power In plug IP65 SEETRONIC

	<b>CEE200</b> Code : H1659	CEE 22 chassis female
	<b>CEE400</b> Code : H0226	CEE 22 plug - female
	<b>FIC/FEM</b> Code : H1805	Female plastic plug 2 poles + earth
	<b>FIC/CAH/FEM</b> Code : H1807	Female plug 2 poles + earth
	<b>FIC/SCHU/FEM</b> Code : H8132	Female rubber plug IP44 standard French
	<b>ADAPTER POWERCON TO IP-POWER</b> Code : B01365	
	<b>SAC3MX</b> Code : H10721	Waterproof Power Out plug IP65 SEETRONIC
	<b>BT-16FS-F</b> Code : B01406	Blue plug with IP44 cover, 230V/16A FRA/BEL

\* IP-POWER (input)/POWERCON (output) conversion adapter from IP class to normal Powercon connector.

\*\* POWERCON (input) / IP-POWER (output) conversion adapter from normal Powercon connector to IP class connector.











































# CONNECTORS

	J35ST Code : H10876	Chrome stereo 3.5 jack plug
	J35STVIS Code : H10828	Chrome stereo 3.5 jack plug with screws
	FXF/CH Code : H2487	AUDIOPHONY XLR female plug - chrome finish
	FXF/NO Code : H7932	AUDIOPHONY X female plug - Black
	FXM/CH Code : H2488	AUDIOPHONY XLR male plug - chrome finish
	FXM/NO Code : H7933	AUDIOPHONY X male plug - Black
	XFC-103 Code : H6586	AUDIOPHONY D Series XLR female chassis
	XMC-103 Code : H6585	AUDIOPHONY D series XLR male chassis
	XMK-105 Code : H6587	5-pin male XLR plug for the AUDIOPHONY DMX
	XFK-105 Code : H6588	5-pin female XLR plug for the AUDIOPHONY DMX
	FJM/CH Code : H2495	AUDIOPHONY mono 6.35mm jack plug - chrome finish
	FJS/CH Code : H2496	AUDIOPHONY stereo 6.35mm jack plug - chrome finish
	J350/MO Code : H7936	AUDIOPHONY mono 6.35mm Jack female plug pro
	J350/STE Code : H7937	AUDIOPHONY professional stereo jack female plug - 6.35mm
	J700 Code : H7939	Stereo 6.35 mm jack female chassis with AUDIOPHONY lock
	RCA910/RO Code : H7940	Red male RCA plug for AUDIOPHONY professional cable
	RCA910/NO Code : H7941	Black male RCA plug for AUDIOPHONY professional cable
	RCA920/RO Code : H7942	Red female RCA plug for AUDIOPHONY professional cable
	RCA920/NO Code : H7943	Black female RCA plug for AUDIOPHONY professional cable

	BANA100/NO Code : H1653	AUDIOPHONY male banana plug - Black
	BANA100/RO Code : H1652	AUDIOPHONY male banana plug - Red
	BANA200/NO Code : H1655	AUDIOPHONY female banana chassis - Black
	BANA200/RO Code : H1654	AUDIOPHONY female banana chassis - Red
	BANA150/NO Code : H6595	AUDIOPHONY connector for amplifier terminal block, black
	BANA150/RO Code : H6596	AUDIOPHONY connector for amplifier terminal block, red
	BANA400/NO Code : H7944	AUDIOPHONY 2 x female banana chassis - 1 Red / 1 Black
	XLR female CHASSIS D-SIZE Code : B01306	XLR female chassis
	XLR male CHASSIS D-SIZE Code : B01305	XLR male chassis
	SC3FXX-W Code : H10716	XLR 3P female waterproof plug IP65 SEETRONIC
	SC3MXX-W Code : H10717	XLR 3P waterproof male plug IP65 SEETRONIC
	SC5FXX-W Code : H10718	XLR 5P female waterproof plug IP65 SEETRONIC
	SC5MXX-W Code : H10719	XLR 5P waterproof male plug IP65 SEETRONIC
	PROLOCK female CABLE Code : B01308	Female Pro Lock Connector
	PROLOCK male CABLE Code : B01307	Pro Lock Male Connector
	RCA female CABLE Code : B01311	RCA Female Connector
	RCA male CABLE Code : B01310	RCA Male Connector
	STEREOJACK 6.3mm FEMALE CABLE Code : B01302	stereo female 6.3mm jack
	STEREOJACK 6.3mm MALE CABLE Code : B01301	Stereo male 6.3mm jack
	XLR female CABLE Code : B01304	XLR female Connector
	XLR male CABLE Code : B01303	XLR male Connector

# ADAPTERS

	ADAPT400 Code : H0505	AUDIOPHONY RCA female / mono male 6.35 jack adapter		ADAPT500 Code : H0766	AUDIOPHONY female 6.35 jack / RCA male adapter
	ADAPT600 Code : H1656	AUDIOPHONY 2 RCA female / 1 RCA male adapter		ADAPT700 Code : H1657	AUDIOPHONY RCA female / RCA female adapter
	ADAPT750 Code : H7927	AUDIOPHONY 2 x RCA female / 2 RCA female adapter		ADAPT800 Code : H0767	AUDIOPHONY female 6.35 jack / female 6.35 jack adapter
	ADAPT850 Code : H0506	AUDIOPHONY 2 female 6.35 jack / 1 male 6.35 jack adapter		ADAPT900 Code : H1658	AUDIOPHONY 2 RCA female / 1 stereo male 6.35 jack adapter
	ADAPT1000 Code : H7928	AUDIOPHONY stereo female 3.5 jack / stereo male 6.35 kack adapter		ADAPT1005 Code : H7929	AUDIOPHONY stereo female 6.35 jack / stereo male 3.5 jack adapter
	ADAPT1105 Code : H7931	AUDIOPHONY stereo RCA female / stereo male 3.5 jack adapter		ADAPT1200 Code : H9278	AUDIOPHONY stereo male 6.35 jack to 2 x 3 jack adapter
	ADA/XMXM Code : H2500	AUDIOPHONY XLR male / XLR male adapter		ADA/XFXF Code : H2501	AUDIOPHONY XLR female / XLR female adapter
	ADA/XFJF Code : H2502	AUDIOPHONY XLR female / female jack adapter		ADA/XMZF Code : H2503	AUDIOPHONY XLR male / female jack adapter
	ADA/XFRM Code : H2504	AUDIOPHONY XLR female / RCA male adapter		ADA/XMRM Code : H2505	AUDIOPHONY XLR male / RCA male adapter
	ADA/XFRF Code : H2506	AUDIOPHONY XLR female / RCA female adapter		ADA/XMRF Code : H2507	AUDIOPHONY XLR male / RCA female adapter
	ADA/XFJM Code : H6560	AUDIOPHONY XLR female / mono male jack adapter		ADA/XFJMS Code : H6561	AUDIOPHONY XLR female / stereo male jack adapter
	ADA/XMJM Code : H6562	AUDIOPHONY XLR male / mono male jack adapter		ADA/XMJMS Code : H6563	AUDIOPHONY XLR male / stereo male jack adapter
	ADA/XF5XM <sup>3</sup> Code : H7925	AUDIOPHONY DMX XLR female 5 pins / XLR male 3 pins adapter		ADA/XM5XF3 Code : H7926	AUDIOPHONY DMX XLR male 5 pins / XLR female 3 pins adapter
	AS/SF-SF Code : H6583	AUDIOPHONY speaker extension adapter, 2 contacts		Adapter JACKf/JACKf Code : B01319	2x female jack adapter (stereo) with lock
	RCA female/MONOJACK adapter Code : B01312			RCA/RCA adapter Code : B01309	Double RCA female / female adapter
	RCAf/XLRf adapter Code : B01320			RCAf/XLRm adapter Code : B01321	Adapter RCAf/XLRm
	XLR female/ST.JACK adapter Code : B01314			XLR female/ST.JACK female adapter Code : B01316	
	XLR female/XLR female adapter Code : B01317			XLR male/ST.JACK adapter Code : B01313	XLR male / stereo male jack adapter
	XLR male/ST.JACK female adapter Code : B01315			XLR male/XLR male adapter Code : B01318	
	XLRmale 3P / XLRfem 5P adapter Code : B01277			XLRmale 5P / XLRfem 3P adapter Code : B01278	
	MONOJACK 6.3mm MALE CABLE Code : B01300			HEADPHONE ADAPTER Code : B01322	Universal headphone adapter



# CONSTRUCTION

	<b>COIN2PGM</b> Code : H0735	2-legged metal corner - large model
	<b>COIN3P</b> Code : H0422	3-legged metal corner - medium model
	<b>POIGNSURF</b> Code : H0279	Recessed spring surface handle
	<b>POIGNMARCH/PM</b> Code : H4650	Metal Marshal handle - 220 x 160 x 60 mm
	<b>ROUE100</b> Code : H0288	Swivel caster diameter 100 mm
	<b>GRENOUILLE</b> Code : H0698	Draw bolt
	<b>PAPILLONGM</b> Code : H0268	Large butterfly latch
	<b>ECROUCAGE</b> Code : H0270	Cage nut for PROFILRACK
	<b>VISRACK/16</b> Code : H0271	Cage nut screw diameter 6 mm length 16 mm
	<b>RENFORT</b> Code : H0290	Metal corner reinforcement
	<b>VCA512</b> Code : H8882	5x12 fluted rivet (box of 100)
	<b>V561</b> Code : H8880	Black flat plastic washer - 5.5 x 10mm (per 100pcs)
	<b>CORN3020</b> Code : H0287	Aluminium angle 30 x 20 mm - 2 m bar
	<b>HYBRIDE10</b> Code : H0284	Aluminium hybrid profile - 2 m bar
	<b>TOLE1U-NO</b> Code : H0736	19" panel height 1 unit
	<b>TOLE3U-NO</b> Code : H0738	19" panel metal height 3 units
	<b>TOL12XLR</b> Code : H0423	19" panel 1 unit for 6 XLR male chassis and 6 XLR female chassis
	<b>TOLE2UV-NO</b> Code : H0367	19" panel, height 2 units, vented - special aeration

	<b>COIN3PPM</b> Code : H0274	3-legged metal corner - small model
	<b>COIN3PGM</b> Code : H0734	3-legged metal corner - large model
	<b>POIGNRENOI</b> Code : H0280	Recessed spring return handle
	<b>POIGNMARCH/GM</b> Code : H4652	Marshal handle, large model - 280 x 160 x 60 mm
	<b>ROUE100FREIN</b> Code : H0266	Swivel caster diameter 100 mm - with brake
	<b>PAPILLONPM</b> Code : H0287	Medium butterfly latch
	<b>CHARNDEG</b> Code : H0289	Detachable metal hinge, large model
	<b>VISRACK/12</b> Code : H3085	Rack screw diameter 6 mm length 12 mm
	<b>TAMPON</b> Code : H0273	Rubber foot, large model
	<b>VCA412</b> Code : H8881	4x12 fluted rivet (box of 100)
	<b>VCA516</b> Code : H8883	5x16 fluted rivet (box of 100)
	<b>CORN2020</b> Code : H0283	Aluminium angle 20 x 20 mm - 2 m bar
	<b>CORN3030</b> Code : H0282	Aluminium angle 30 x 30 mm - 2 m bar
	<b>PROFILRACK</b> Code : H0281	Sliding rack profile - 2 m bar
	<b>TOLE2U-NO</b> Code : H0737	19" panel height 2 units
	<b>TOLE4U-NO</b> Code : H0739	19" panel metal height 4 units
	<b>TOLE1UV-NO</b> Code : H0368	19" panel, height 1 unit, vented
	<b>ETAGÈRE2U</b> Code : H1626	Metal shelf height 2 units

# CONSTRUCTION

	JB1200 Code : B00930	JB SYSTEMS Large recessed handle for speaker		JB14 Code : B00926	JB SYSTEMS bass tube-Recessed bass-reflex tube for speaker
	JB6 Code : B00921	JB SYSTEMS Small recessed handle for speaker		JB7 Code : B00922	JB SYSTEMS Rubber foot for speaker
	JB8 Code : B00932	JB SYSTEMS Plastic protection corner for speaker		SA65 Code : B00735	JB SYSTEMS 35mm metal adapter for speaker stands
	SPEAKER GRILL 10inch Code : B00910	Strong black metal grill		SPEAKER GRILL 12inch Code : B00911	Strong black metal grid
	SPEAKER GRILL 15inch Code : B00912	Strong black metal grid		SPEAKER GRILL 18inch Code : B00913	Strong black metal grid
	SPEAKER GRILL 8inch Code : B00909	Strong black metal grid		TE10 Code : B00915	Connection plate for loudspeaker with 2 terminal blocks
	TE20 Code : B00918	Connection plate with 2x Speakon compatible connector <sup>®</sup> and 2 screw connectors		A.CONTROLLER/ALU Code : B03187	Adapter for 2U/3U controllers
	MS-00 Code : B03189	JV CASE 4x M6x16 + 4x plastic washers + 4x cage nut 2.2mm		MS-01 Code : B03160	JV CASE 4x M6x16 + 4x plastic washers + 4x cage nut 3mm
	MS-02 Code : B03163	JV CASE 4x M6x16 + 4x plastic washers + 4x cage nut 1.5mm		MS-03 Code : B03164	JV CASE 20x black PVC washers M6
	MS-04 Code : B03165	JV CASE 12x screw rack M6x16 + 12x plastic washers		MS-06 Code : B03178	JV CASE 12x M6 bolt x20 + 12x M6 nuts.
	MS-07 Code : B03190	JV CASE Set 50x M3 screws/nuts for mounting Conn. of size D.		MS-08 50x M4x16 bold-Mennekes Code : B03191	Set 50x M4 screws/nuts for mounting AC outlet.
	RACK DRAWER 2U Code : B03194	JV CASE 19" 2U drawer for rack		RACK DRAWER 3U Code : B03196	JV CASE 19" 3U drawer for rack
	RACK TRAY 1U Code : B03197	JV CASE 19" 1U shelf		RACK TRAY 2U Code : B03198	JV CASE 19" 2U shelf
	RP 0.5U - 1/2U Rack panel Code : B03142	JV CASE 19" panel.		RP 1U - 1U Rack panel Code : B03143	19" panel 1U
	RP 1U/V - 1U ventilation rack panel Code : B03147	Vented 19" panel 1U		RP 1U/XLR - XLR (D-size) Code : B03149	19" panel 1U for 12 x XLR
	RP 2U - 2U Rack panel Code : B03144	19" panel 2U		RP 2U/PC-8 Code : B03181	19" 2 units rack panel for 8x Blue Power Outlet
	RP 2U/V - 2U ventilation rack panel Code : B03148	Ventilated 19" panel 2U		RP 3U - 3U Rack panel Code : B03145	19" panel 3U



# LOUDSPEAKERS AND FILTERS

	SCX-12400 Code : B00850	SYNQ Powerful coaxial speaker of 400 W + 45 W of 12" + 1.75" and 60° x 40°.
	JODR-20 Code : H9900	1 inch compression driver for JOGGER60
	CRDR-20 Code : H9897	1.5 inch compression driver for CROSSER180
	SRDR12 Code : H10164	1.35 inch 50W 8 Ohm driver for SR12A and SR15A
	DIA/ACDR-30 Code : H8839	Diaphragm for ACDR-30
	SDR-50 Code : H9815	Driver for S8 and S10
	MOJOLINE-275 Code : H10586	2.75-inch tweeter for MOJO500LINE
	CDR-20 Code : H10315	1-inch 20W 8 Ohm tweeter for CR80A
	JB330 Code : B00801	85x85mm piezo tweeter
	JB660 Code : B00804	161x94mm dual piezo tweeter
	PTX34 Code : B00685	HF Driver: 1.50" - 50W 8 Ohm
	SXDR-50 Code : H10853	1.35-inch driver for SX12A and SX15A speakers
	AXO-AC08 Code : H9631	Passive filter for ACUTE08 passive
	AXO-S8 Code : H9725	Filter for S8
	AXO-COMPACT Code : H9399	2-way filter for COMPACT satellite
	AXO-SR10P Code : H10320	2-way filter for SR10P speaker
	AXO-SR15P Code : H10322	2-way filter for SR15P speaker
	AXOHL Code : H10591	2-way passive filter for HL-4
	CN-3 Code : B00615	High pass filter for 2-way system [X-over freq. : 7kHz, Slope: 12dB/oct RMS power: 100W]
	CN-9 Code : B00814	2 way professional filter [X-over freq. : 2kHz, Slope: 12dB/oct, RMS power: 200W]

	SCX-15450 Code : B00851	SYNQ Powerful 450W + 60W coaxial speaker of 15" + 1.75" and 60°x40°
	SPDR-20 Code : H9639	1 inch compression driver for SPRINTER120
	SRDR10 Code : H10163	1 inch driver for SR10A speaker
	ACDR-30 Code : H8838	Driver for COMPACT, SATCOM16, S6, D12 and D15 satellites
	OCDR-20 Code : H9400	COMPACT, SATCOM16, S6, D12 and D15 satellite engine
	HLTR Code : H10590	8 Ohm ribbon tweeter for HL-4
	CODR-20 Code : H10309	1-inch 20W 8 Ohm tweeter for COMPACT-500 satellite
	HT30 Code : B00806	1" capton 150W 8 Ohm bullet tweeter
	JB550 Code : B00803	187x80mm piezo tweeter
	PH2 Code : B00823	Horn for PTX34 and PTX44
	PTX44 Code : B00686	HF Driver: 1.75" - 50W 8ohm
	HT100 Code : B00807	1" capton 300W 8 Ohm bullet tweeter
	AXO-S6 Code : H9724	Filter for S6
	AXO-S10 Code : H9727	Filter for S10
	AXO-OCTAVE Code : H9394	2-way filter for OCTAVE satellite
	AXO-SR12P Code : H10321	2-way filter for SR12P speaker
	AXO-COMPACT500 Code : H10310	2-way filter for COMPACT-500 satellite
	CN-12 Code : B00815	2-way professional filter [X-over freq. : 1.8kHz, Slope: 12dB/oct, RMS power: 300W]
	CN-6 Code : B00813	High pass filter for 2-way system [X-over freq. : 4.5kHz, Slope: 18dB/oct RMS power: 100W].



# LOUDSPEAKERS AND FILTERS

	CR25WB-200 Code : H10856	12-inch woofer for CR25A-COMBO
	SXWB15-200 Code : H10852	15-inch 250W woofer for SX15A
	iLINEw320 Code : H10765	HP 3" 20W for iLINE series columns
	SRWB12-350 Code : H10161	12" 350W 4 Ohms woofer for SR12A speaker
	SRWB12-350-8 Code : H10318	12-inch 350W 8 Ohm woofer for SR12P
	ACW08-104 Code : H8742	8-inch woofer for ACUTE-08 / AMP
	MIOSW6100 Code : H10151	6.5" 100W woofer for SYSTEM1 Sub
	SW8-150 Code : H9816	8-inch woofer for S8
	OWB6-100 Code : H9401	6.5" 8 Ohms 100 W woofer for COM-PACT and S6 satellites
	JOG5-30 Code : H9636	5-inch 30W 4 Ohm woofer for JOGGER50
	SPW10-120 Code : H9638	10-inch woofer 100W for SPRINTER120
	CRW6-60 Code : H10314	6.5-inch 80W 8 Ohm woofer for CR80A
	OWB12-400-8 Code : H9402	12-inch 400W 8 Ohm woofer for COMPACT subwoofer
	HLWB10 Code : H10589	10-inch 8 Ohm woofer for HL-10ASUB
	HLWB8 Code : H10588	8-inch 8 Ohm woofer for HL-08ASUB
	CUBW12-300 Code : H10728	12-inch 300W woofer for CUBsub112
	SRWB18-600 Code : H10733	18-inch woofer for SRSUB18A
	COW4-60 Code : H10308	4.75-inch 80W 8 Ohm woofer for COM-PACT-500 satellite
	PWX 12/200 Code : B00680	Woofer 12 inches / 200Wrms
	PWX 18/400 Code : B00683	18-inch / 400Wrms woofer
	SP-12/200 Code : B00666	12-inch / 200W woofer

	SXWB12-200 Code : H10851	12-inch 200W woofer for SX12A
	SRWB10-250 Code : H10160	10-inch 250W 4 Ohm woofer for SR10A speaker
	SRWB15-350 Code : H10162	15" 350W 4 Ohms woofer for SR15A speaker
	SRWB15-350-8 Code : H10319	15-inch 350W 8 Ohm woofer for SR15P
	ACW08-108 Code : H9629	8-inch 8 Ohm woofer for ACUTE08 passive
	MIOSW8150 Code : H10155	8" 150W woofer for SYSTEM2 Sub
	SW10-250 Code : H9726	10-inch woofer for S10
	OWB8-108 Code : H9630	8-inch 170W 8 Ohms woofer for Octave satellite
	JOG5-40 Code : H9901	5 1/4-inch woofer for JOGGER60
	CRW10-180 Code : H9899	10-inch woofer for CROSSER180
	OWB15-600 Code : H9106	15" woofer used in OCTAVE, SUB115-AMP, EX15S, EX215S subwoofers
	CW10-150 Code : H9301	10-inch woofer used in the CB-210
	HLWB4 Code : H10587	4-inch 8 Ohms woofer for HL-4
	MOJOLINE-08 Code : H10585	8-inch woofer for MOJ0500LINE
	CUBW08-150 Code : H10729	8-inch 150W woofer for CUBsub208
	COWB10-300 Code : H10307	10-inch 300W 4 Ohm woofer for COM-PACT-500 subwoofer
	PWX 10/200 Code : B00679	10-inch / 200Wrms woofer
	PWX 15/300 Code : B00681	15-inch / 300Wrms woofer
	SP-10/150 Code : B00665	10-inch / 150W woofer
	SP-15/250 Code : B00667	15-inch / 250W woofer



# LAMPS

	LPAR36/4515 Code : H0132	GE lamp PAR36 6V 30W 4515
	LPAR56/WFL Code : H8662	GE lamp PAR56 240V 300W 37° x 20°
	MASTER LEDspot PAR20 DIM Code : B06501	PHILIPS LED LAMP 6W--2700K- E27-25°-DIM
	MASTER LEDspot PAR38 DIM Code : B06503	PHILIPS LED LAMP 13W-2700K- E27-25°-DIM
	GY9.5500 Code : H0296	Philips lamp CP82 240V 500W
	GX9.51000 Code : H0295	Lamp CP70 240V 1000W
	LR7S/118-500 Code : H9011	Lamp R7S 240V 500W 2900°K 2000H
	LHID-150 Code : H8984	Lamp type HID-150 95V 150W 6500 °K 1000H
	L2R Code : H10165	Philips® MSD Platinum 2R lamp
	SIRIUS HRI 280W FS1 Code : B02179	OSRAM Metal halogen lamp, 280Watt, 2000h, 7800K
	LMSD-250/2 Code : H8994	Lamp type MSD-250-2 94V 250W 8000°K 2000H
	LBVM1 Code : H9006	Lamp type BVM 120V 300W 3200°K 150H
	LBVM3 Code : H9007	Lamp type BVM 240V 300W 3200°K 75H
	G6.3540036 Code : H0626	Osram lamp EVD 36V 400W
	LEFR Code : H9009	Lamp type EFR 15V 150W 3400°K 50H
	ELC25024 Code : H3119	Philips lamp ELC 24V 250W
	ENH250120 Code : H0177	Osram lamp ENH 120V 250W

	LPA56/MFL Code : H0131	Osram lamp PAR56 240V 300W
	MASTER LEDspot PAR16 DIM Code : B06500	PHILIPS LED LAMP 3.7W-2700K-GU10-25°-DIM
	MASTER LEDspot PAR30 DIM Code : B06502	PHILIPS LED LAMP 9.5W-2700K-E27-25°-DIM
	LED-GU10-5W-WW-38D Code : B02258	LED lamp GU10, 5W - 240Vac DIM, warm white, 38°
	GY9.5650 Code : H0297	GE lamp T26 240V 650W
	GX9.51000/T19 Code : H2590	Lamp T19 240V 1000W
	HPL 575-X LL 230v Code : B02171	GE Lighting Halogen lamp, no reflector, 575W/230V, sp. socket
	LHRI100 Code : H10432	OSRAM SIRIUS HRI lamp 100W,6000h,9000°K
	L5R Code : H10357	Philips MSD Platinum 5R lamp
	L15R Code : H10358	Philips MSD Platinum 15R lamp
	MSD250/2-05 Code : H3425	Osram lamp MSD 250W
	G6.35300110 Code : H1247	Osram lamp 64514 120V 300W
	G6.35300220 Code : H0628	Osram lamp 64516 240V 300W
	EFP10012 Code : H0624	Philips or Osram lamp EFP 12V 100W
	LELC Code : H9008	Lamp type ELC 24V 250W 3200°K 50H
	LELC/LD Code : H8986	lamp type ELC 24V 250W 3200 °K 300H
	LST/1500 Code : H9021	Lamp strobe type-3 1500W 5600°K 500H 120Hz max





[WWW.AUDIOPHONY.COM](http://WWW.AUDIOPHONY.COM)



[WWW.CONTEST-LIGHTING.COM](http://WWW.CONTEST-LIGHTING.COM)



[WWW.BRITEQ-LIGHTING.COM](http://WWW.BRITEQ-LIGHTING.COM)



[WWW.JB-SYSTEMS.EU](http://WWW.JB-SYSTEMS.EU)



[WWW.SYNQ-AUDIO.COM](http://WWW.SYNQ-AUDIO.COM)



[WWW.HILEC.EU](http://WWW.HILEC.EU)

See conditions at your retailer. Within the limits of available stocks. Information is subject to typographical errors. The technical specifications, photos, illustrations and prices in this catalogue are not binding. In order to improve our products, modifications can be made.  
Catalogue in effect as of March 12, 2018.

AUDIOPHONY®, CONTEST®, JBSYSTEMS®, BRITEQ®, JV CASE® and SYNQ® are registered trademarks of HITMUSIC SAS and BEGLEC NV.

Any reproduction of the catalogue, even partial, or use of the logos or design of the intellectual property is prohibited, without prior written permission from HIT MUSIC SAS and/or BEGLEC NV.

Catalogue published by HIT MUSIC SAS - Parc d'Activités CAHORS SUD - EN TESTE - 46230 FONTANES - France.  
Product photo credits : Studio ZE and BEGLEC NV. - Ambience photo credits : © Shutterstock - Creation: Agence NOVO & HITMUSIC SAS

MKT-CATA2018  
ANG / SANS PRIX



3 662009 019505

code H10892